

ST - T44

Rt °C/W 10.5

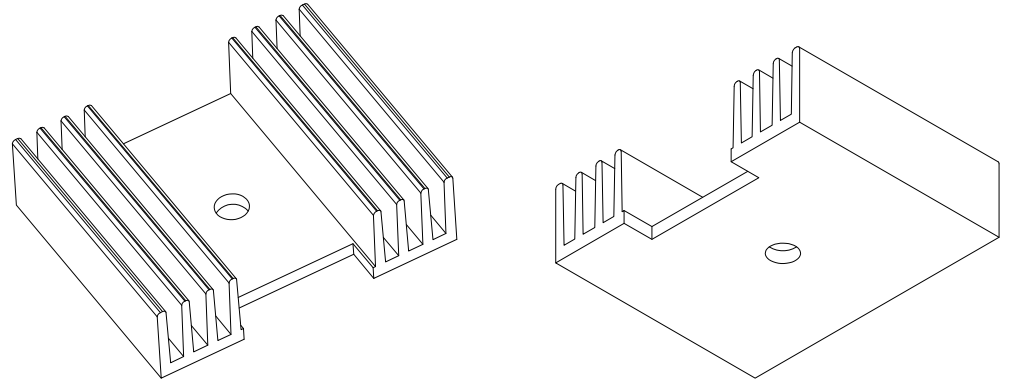
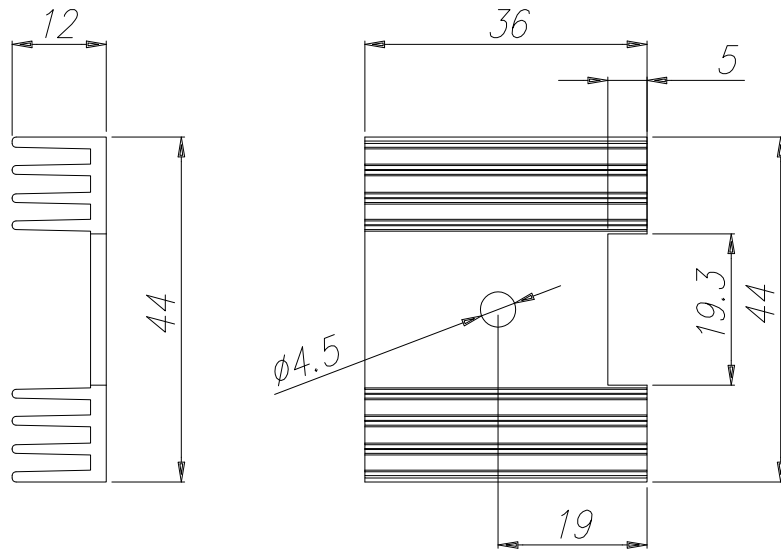

Aluminium, black anodized
Aluminium, pre-black anodized
Aluminium, raw
Other dimensions on request

on stock
on request
on request

ATECNAL
BOLOGNA - ITALY

ATD Elektronik s.r.o.
Luženice 10
344 01 Domažlice
Tel.: 379 723 915
Fax: 379 725 868
www.atd-elektronik.cz
info@atd-elektronik.cz

