

ST - T29

Rt °C/W 17

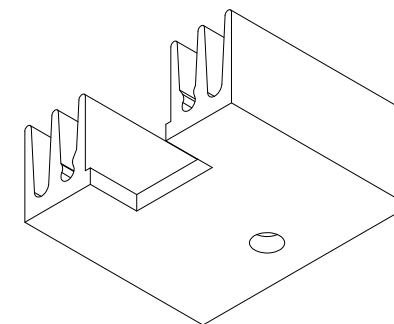
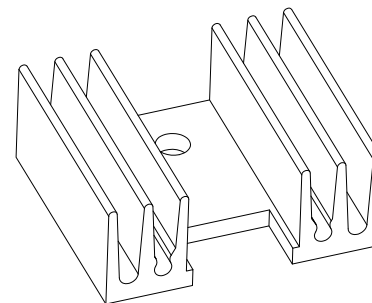
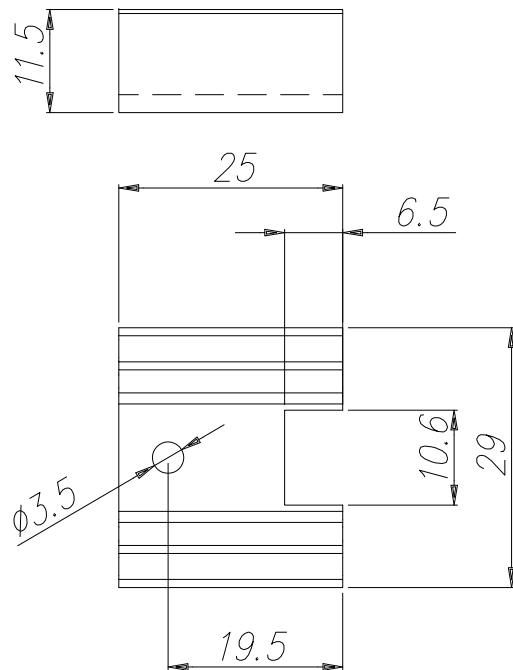
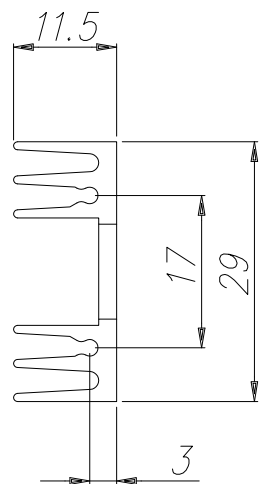

Aluminium, black anodized  
Aluminium, pre-black anodized  
Aluminium, raw  
Other dimensions on request

**on stock**  
on request  
on request

ATECNAL  
BOLOGNA - ITALY

ATD Elektronik s.r.o.  
Luženice 10  
344 01 Domažlice  
Tel.: 379 723 915  
Fax: 379 725 868  
[www.atd-elektronik.cz](http://www.atd-elektronik.cz)  
[info@atd-elektronik.cz](mailto:info@atd-elektronik.cz)

**ATD**  
ELEKTRONIK s.r.o.