

T94

Peso Kg/m
Weight Kg/m

1.55

Rt °C/W 3.1

Lung. campione mm
Sample length mm 100

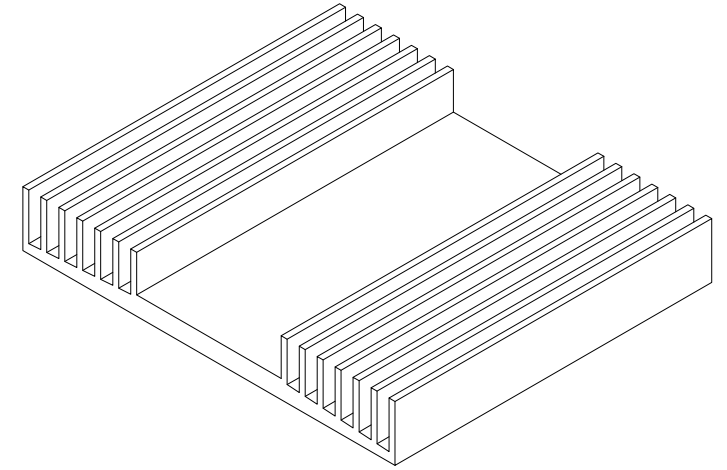
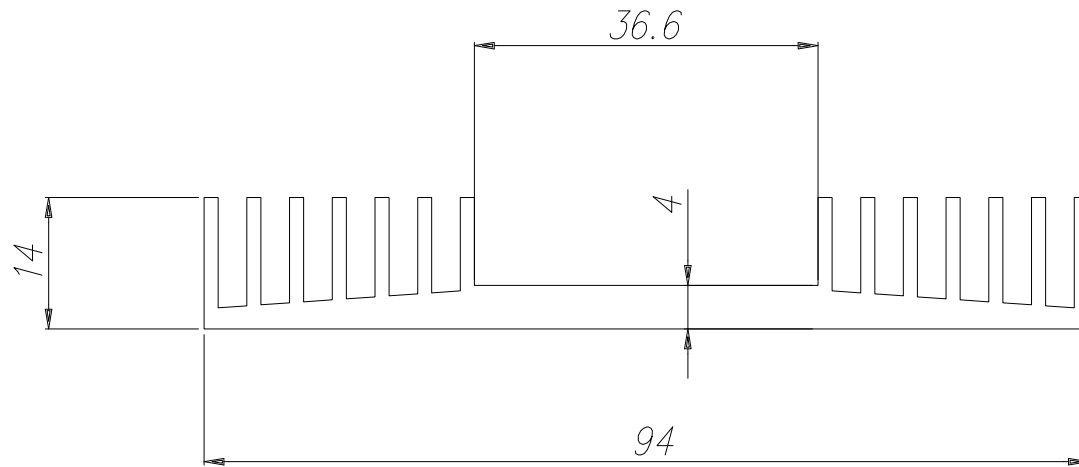

A TECNOAL
BOLOGNA - ITALY

ATD Elektronik s.r.o.
Luženice 10
344 01 Domažlice
Tel.: 379 723 915
Fax: 379 725 868
www.atd-elektronik.cz
info@atd-elektronik.cz

