

T54

Peso Kg/m
Weight Kg/m

1.24

Rt °C/W

3.3

Lung. campione mm
Sample length mm

100

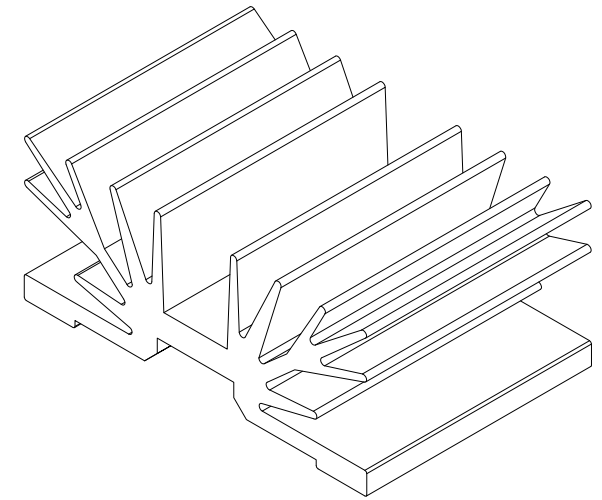
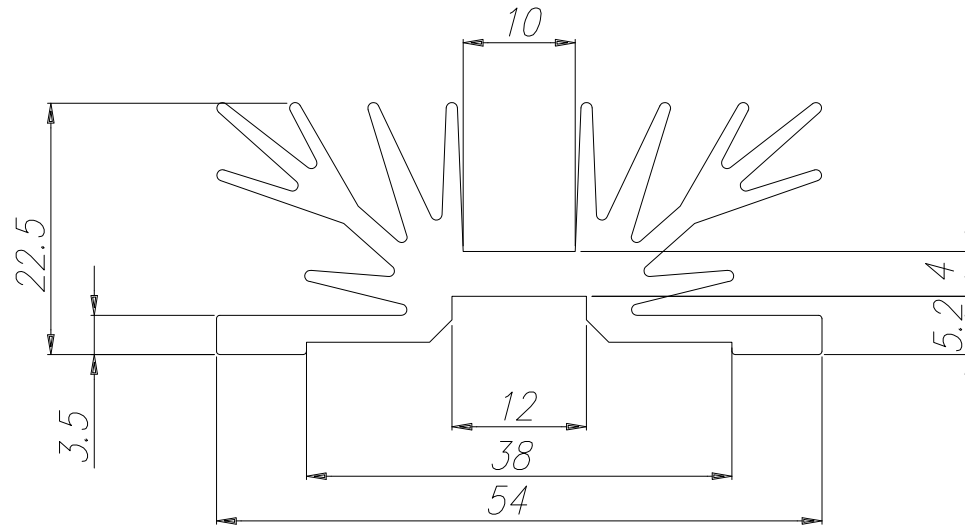

A TECNOAL
BOLOGNA - ITALY

ATD Elektronik s.r.o.
Luženice 10
344 01 Domažlice
Tel.: 379 723 915
Fax: 379 725 868
www.atd-elektronik.cz
info@atd-elektronik.cz

ATD
ELEKTRONIK s.r.o.