

T150

Peso Kg/m  
Weight Kg/m 3.30

Rt °C/W 1.1

Lung. campione mm  
Sample length mm 100

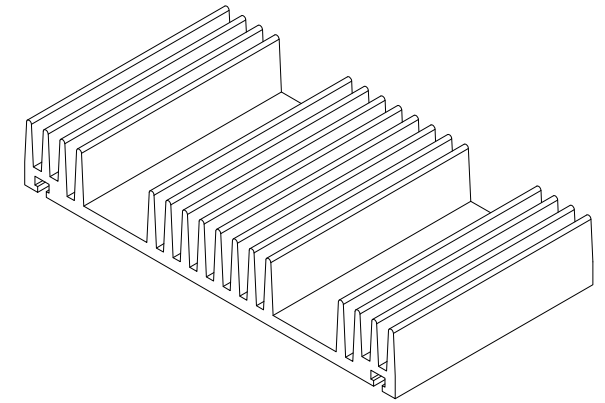
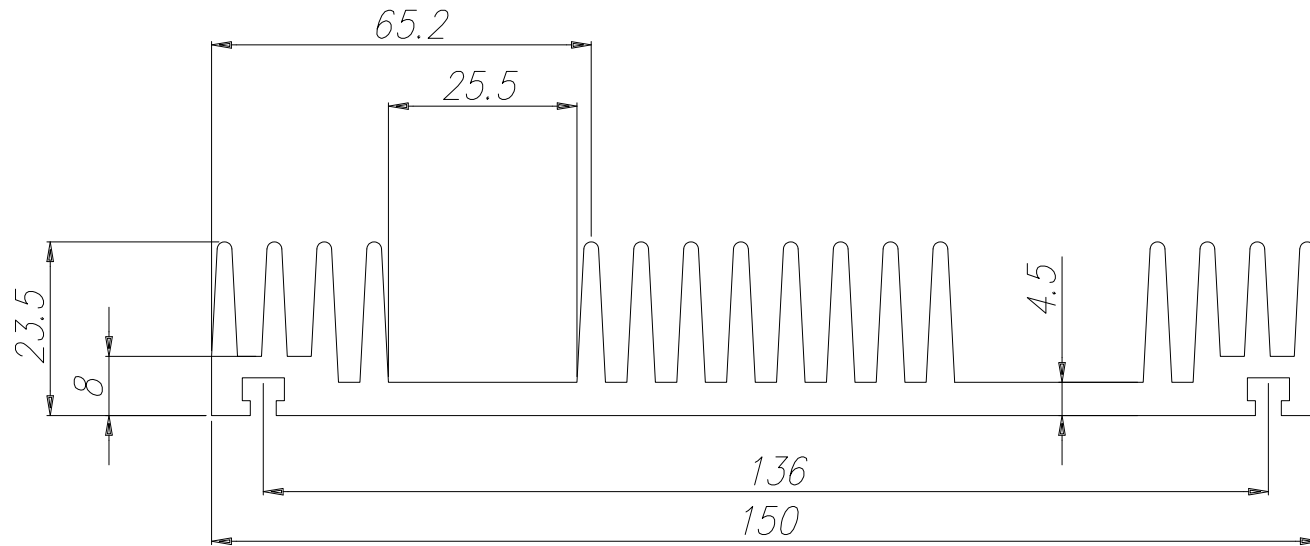

A TECNOAL  
BOLOGNA - ITALY

ATD Elektronik s.r.o.  
Luženice 10  
344 01 Domažlice  
Tel.: 379 723 915  
Fax: 379 725 868  
[www.atd-elektronik.cz](http://www.atd-elektronik.cz)  
[info@atd-elektronik.cz](mailto:info@atd-elektronik.cz)

**ATD**  
ELEKTRONIK s.r.o.