

C118

Peso Kg/m
Weight Kg/m 2.40

Rt °C/W 2.1

Lung. campione mm
Sample length mm 150

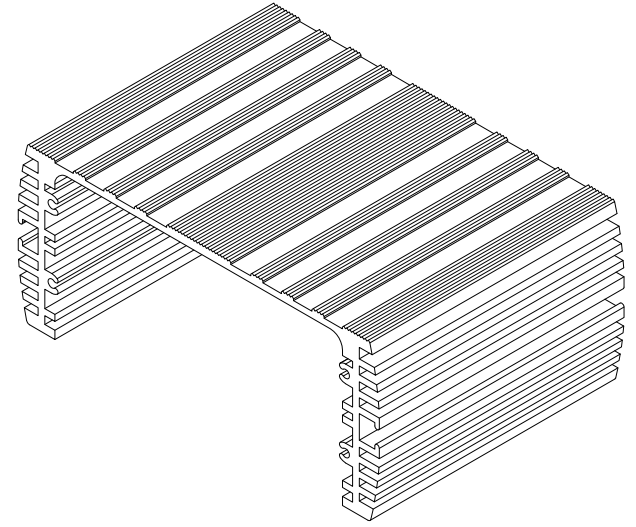
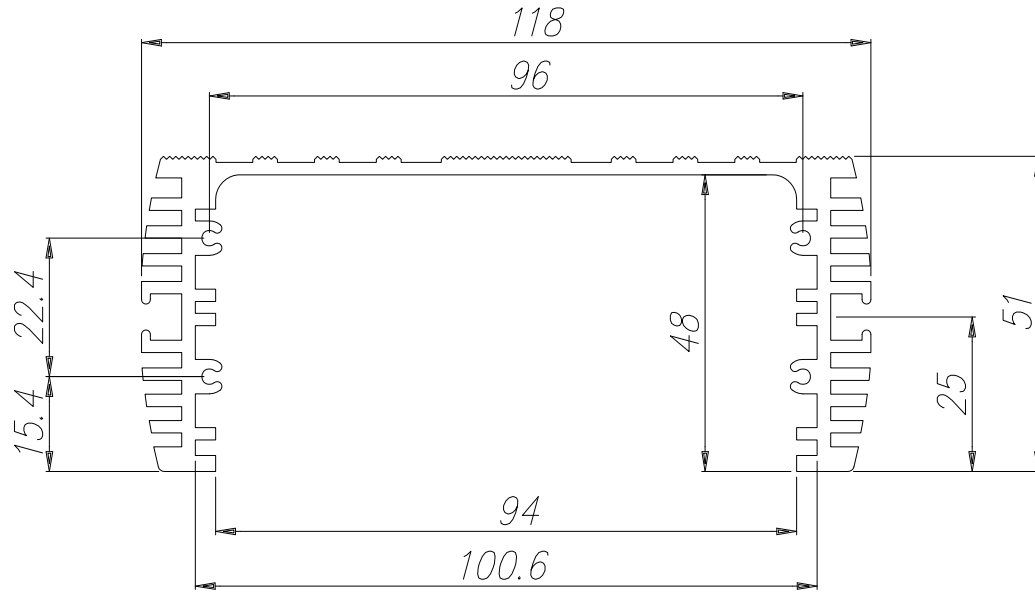

ATECNOAL
BOLOGNA - ITALY

ATECNOAL
MECHANICAL ENGINEERING FOR ELECTRONICS

ATD Elektronik s.r.o.
Luženice 10
344 01 Domažlice
Tel.: 379 723 915
Fax: 379 725 868
www.atd-elektronik.cz
info@atd-elektronik.cz

COMPANY
WITH QUALITY MANAGEMENT
SYSTEM CERTIFIED BY DNV

≡ ISO 9001 : 2000 ≡

Notes:

ATD
ELEKTRONIK s.r.o.