

A135

Peso Kg/m 15.70
Weight Kg/m

Rt °C/W 0.5

Lung. campione mm 200
Sample length mm

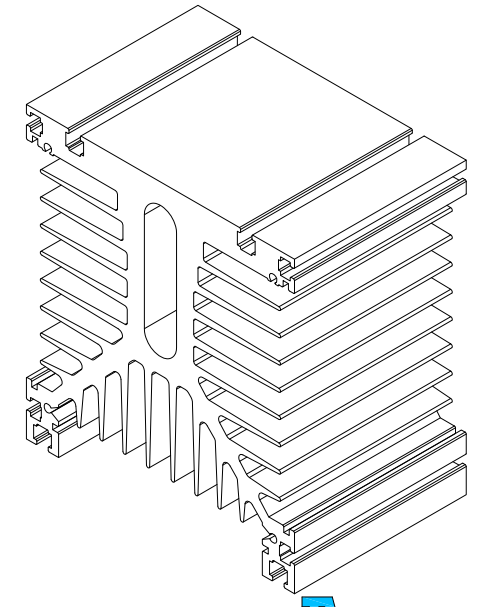
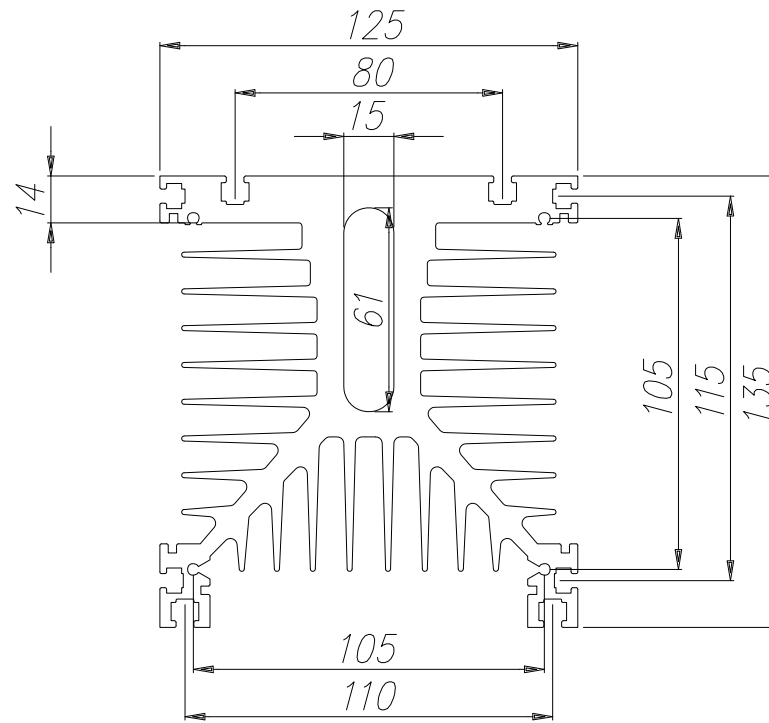

ATECNOAL
BOLOGNA - ITALY

ATECNOAL
MECHANICAL ENGINEERING FOR ELECTRONICS

ATD Elektronik s.r.o.
Luženice 10
344 01 Domažlice
Tel.: 379 723 915
Fax: 379 725 868
www.atd-elektronik.cz
info@atd-elektronik.cz

COMPANY
WITH QUALITY MANAGEMENT
SYSTEM CERTIFIED BY DNV

— ISO 9001 : 2000 —

Notes:

