

AX130

Peso Kg/m
Weight Kg/m

10.05

Rt °C/W ---

Lung. campione mm
Sample length mm ---

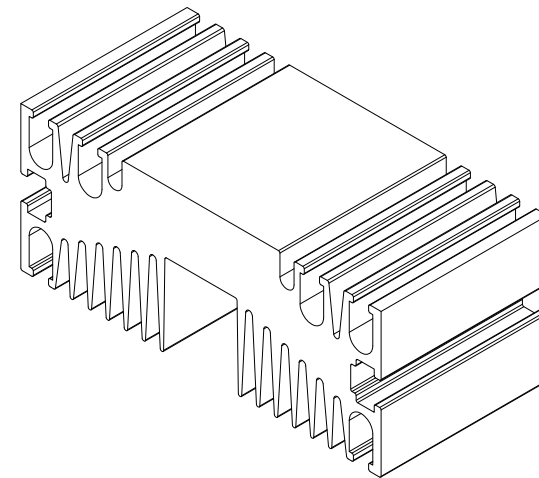
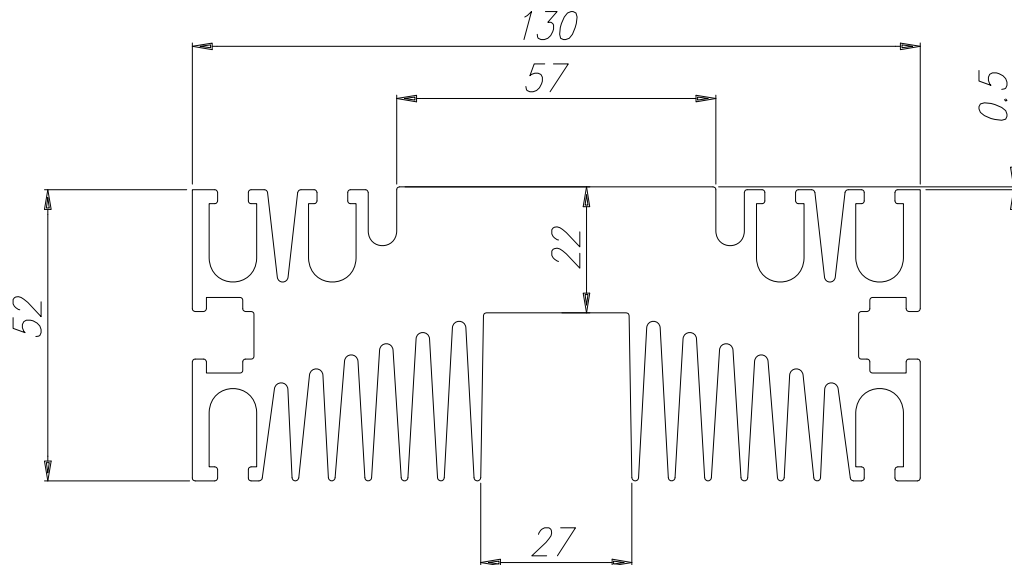

ATECNOAL
BOLOGNA - ITALY

ATECNOAL
MECHANICAL ENGINEERING FOR ELECTRONICS

ATD Elektronik s.r.o.
Luženice 10
344 01 Domažlice
Tel.: 379 723 915
Fax: 379 725 868
www.atd-elektronik.cz
info@atd-elektronik.cz

COMPANY
WITH QUALITY MANAGEMENT
SYSTEM CERTIFIED BY DNV
= ISO 9001 : 2008 =

Notes:

ATD
ELEKTRONIK s.r.o.