

MGV High Current & Low Profile SMD Power Inductors

CATALOGUE



ABOUT LAIRD TECHNOLOGIES

Laird Technologies designs and manufactures customized, performance-critical products for wireless and other advanced electronics applications.

The company is a global market leader in the design and supply of electromagnetic interference (EMI) shielding, thermal management products, mechanical actuation systems, signal integrity components, and wireless antennae solutions, as well as radio frequency (RF) modules and systems.

Laird Technologies partners with its customers to customize product solutions for applications in many industries including:

- Network Equipment
- Handsets
- Telecommunications
- Data Transfer & Information Technology
- Computers
- Automotive Electronics
- Aerospace
- Defense
- Medical Equipment
- Consumer Electronics
- Industrial

Laird Technologies offers its customers unique product solutions, dedication to research and development, as well as a seamless network of manufacturing and customer support facilities across the globe.



TABLE OF CONTENTS

- Features and Applications4
- Part Number Explanation.....4
- Electrical Specifications4
- Product Selection Guide5
- Shapes and Dimensions6
- MGV04027
- MGV05028
- MGV05038
- MGV06029
- MGV06039
- MGV060510
- MGV062510
- MGV100411
- MGV120311
- MGV120512
- MGV120712
- Packaging Information.....14
- Sample Kit Lists15



All parts listed in this catalog are lead free and RoHS compliant.

NOTICE

Laird Technologies' products or subcomponents are not specifically designed or tested by Laird Technologies for use in any medical applications, surgical applications, medical device manufacturing, or any similar procedure or process requiring approval, testing, or certification by the United States food and drug administration or other similar Governmental entity. Applications with unusual environmental requirements such as military, medical, life-support or Life-sustaining equipment are specifically not recommended without additional testing for such application.

FEATURES AND APPLICATIONS

FEATURES

- Magnetic shielded structure
- Low DCR and high efficiency
- Low profile and small size
- High reliability
- AEC-Q200 qualified

APPLICATIONS

- DC-DC converters and power suppliers
- LCD TV's, Blu-ray and gaming consoles
- Tablets, notebooks, servers and printers
- Smart phones, GPS, set top box and base stations
- LED lighting
- Automotive

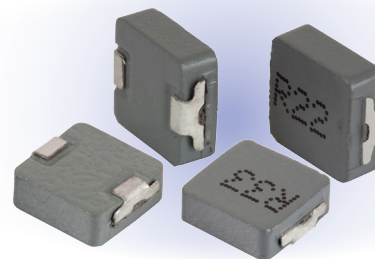

PART NUMBER EXPLANATION

M G V	0 6 2 5	1 R 5	M	- 1 0
Product series code	Part size code	Inductance value code (i.e. 1R5: 1.5 μ H)	Tolerance % (i.e. M: \pm 20%)	PB free code (i.e. 10: PB free)

ELECTRICAL SPECIFICATIONS

- Tolerance: M: \pm 20%
- Inductance tested at 100KHz, 0.25V
- RMS Current is defined based on temperature rise approximate 40°C without core loss.(ambient temperature 25 \pm 5°C)
- Saturation Current is the DC current at which the inductance drops off approximately 25% from its value without current. (ambient temperature 25 \pm 5°C)
- Operating temperature range:-40°C~+125°C (including self-heating temperature rise)
- Storage temperature range (packaging conditions): 25 \pm 5°C and RH 70%(MAX.)

Note: RMS current is tested on a typical PCB and apply a constant current in still air. The temperature rise is dependent on the application system condition including PCB PAD pattern, trace width and thickness and adjacent components etc. It's suggest to verify the temperature rise of the component under the real operation application conditions.

MGV SERIES PRODUCT SELECTION GUIDE

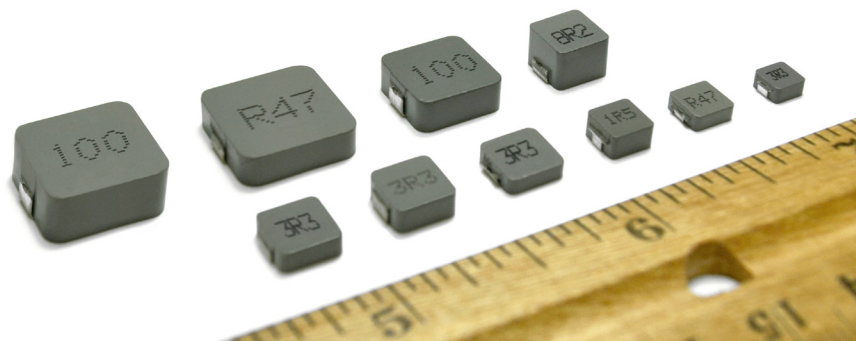

Inductance Range

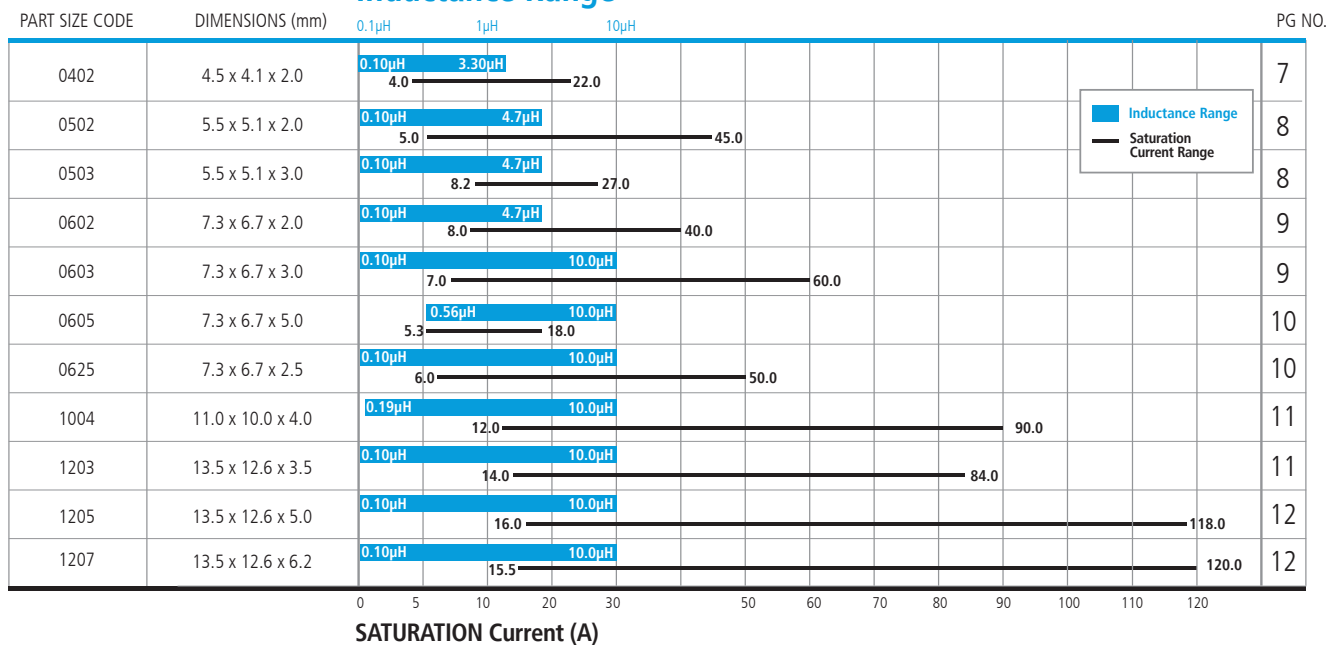

MGV SERIES SHAPES AND DIMENSIONS

SERIES (UNIT: mm)	A	B	C	D	E	a	b	c
MGV0402	4.5±0.5	4.1±0.3	2.0±0.3	1.5±0.3	1.0±0.5	1.5ref	2.5ref	2.2ref
MGV0502	5.5±0.5	5.1±0.3	3.0±0.3		1.2±0.5	2.0ref	3.0ref	2.5ref
MGV0602			7.3±0.5	6.7±0.3	2.0±0.3	2.9±0.3	1.6±0.5	2.5ref
MGV0603	3.0±0.3							
MGV0605	5.0±0.3							
MGV0625	2.5±0.3							
MGV1004	11.0±0.5	10.0±0.3	4.0±0.3	3.6±0.5	2.2±0.5	3.5ref	6.0ref	4.0ref
MGV1203	13.5±0.5	12.6±0.3	3.5±0.3		2.3±0.2	2.9ref	7.9ref	5.0ref
MGV1205			5.0±0.3					
MGV1207			6.2±0.3					

FIGURE

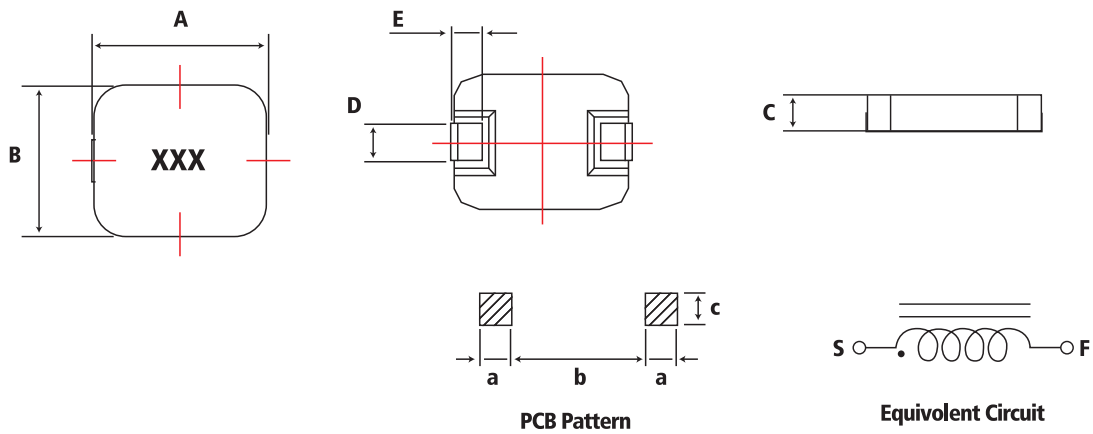

TEMPERATURE PROFILE OF REFLOW SOLDERING

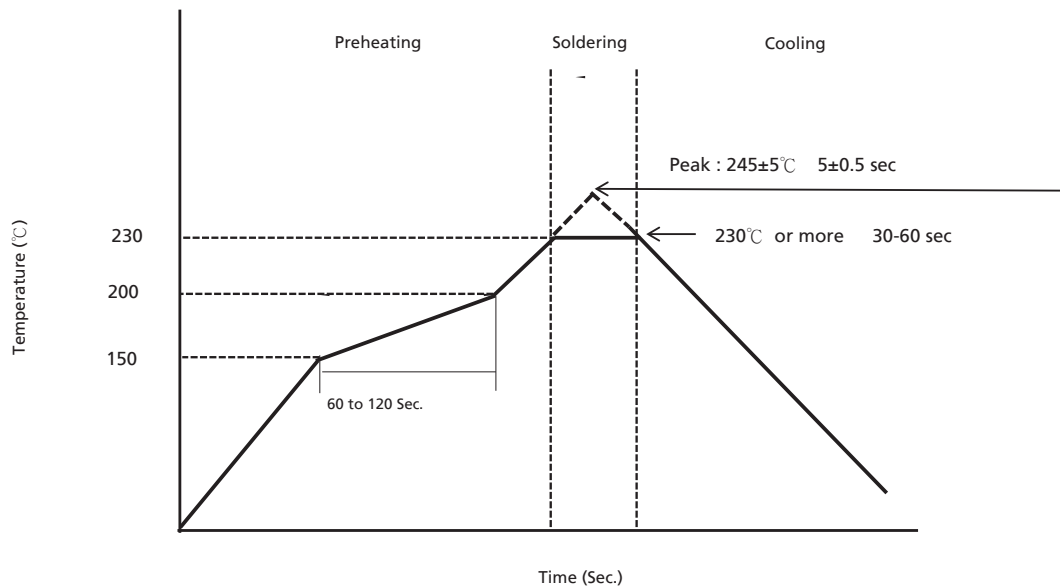

MGV SERIES 0402

ELECTRICAL SPECIFICATIONS

PART NO.	INDUCTANCE (μH) \pm 20%	RDC ($\text{m}\Omega$) Max	SATURATION CURRENT (A)Max	RMS CURRENT (A)Max
MGV0402R10M-10	0.10	4.00	22.0	12.0
MGV0402R22M-10	0.22	6.60	12.5	9.0
MGV0402R47M-10	0.47	14.00	9.5	7.0
MGV0402R56M-10	0.56	16.00	8.5	6.5
MGV04021R0M-10	1.00	27.00	7.0	4.5
MGV04021R5M-10	1.50	46.00	6.0	4.0
MGV04022R2M-10	2.20	58.00	5.0	3.0
MGV04023R3M-10	3.30	87.00	4.0	2.5

TYPICAL ELECTRICAL CHARACTERISTICS

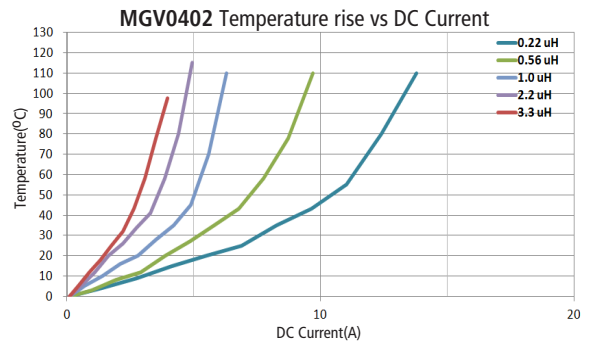
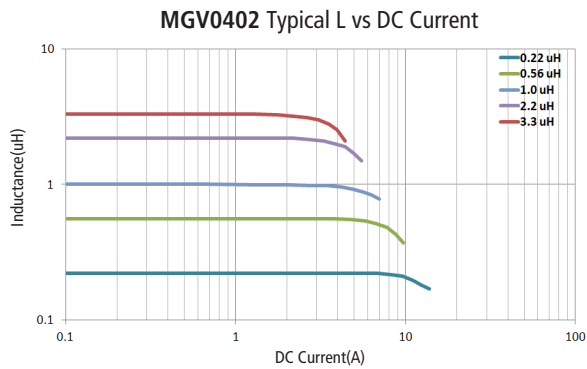

MGV SERIES 0502/0503

ELECTRICAL SPECIFICATIONS

PART NO.	INDUCTANCE (μH) $\pm 20\%$	RDC ($\text{m}\Omega$) Max	SATURATION CURRENT (A)Max	RMS CURRENT (A)Max
MGV0502R10M-10	0.10	3.90	45.0	17.0
MGV0502R22M-10	0.22	5.20	22.0	15.0
MGV0502R33M-10	0.33	8.20	25.0	12.0
MGV0502R47M-10	0.47	9.40	21.0	11.5
MGV0502R68M-10	0.68	12.40	15.0	10.0
MGV05021R0M-10	1.00	20.00	16.0	7.0
MGV05022R2M-10	2.20	50.10	12.5	4.2
MGV05023R3M-10	3.30	85.50	8.5	3.3
MGV05024R7M-10	4.70	116.60	5.0	2.8
MGV0503R10M-10	0.10	3.16	27.0	23.0
MGV0503R22M-10	0.22	4.52	21.0	15.5
MGV0503R33M-10	0.33	5.56	19.0	13.7
MGV0503R47M-10	0.47	7.04	16.0	12.2
MGV0503R68M-10	0.68	8.96	13.5	10.2
MGV0503R82M-10	0.82	11.90	13.0	9.3
MGV05031R0M-10	1.00	13.70	12.0	9.2
MGV05031R5M-10	1.50	20.70	11.0	7.2
MGV05032R2M-10	2.20	29.20	10.0	5.8
MGV05033R3M-10	3.30	54.70	8.5	5.0
MGV05034R7M-10	4.70	77.50	8.2	3.5

TYPICAL ELECTRICAL CHARACTERISTICS

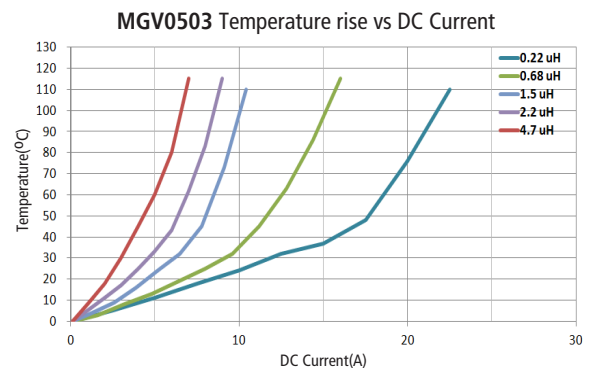
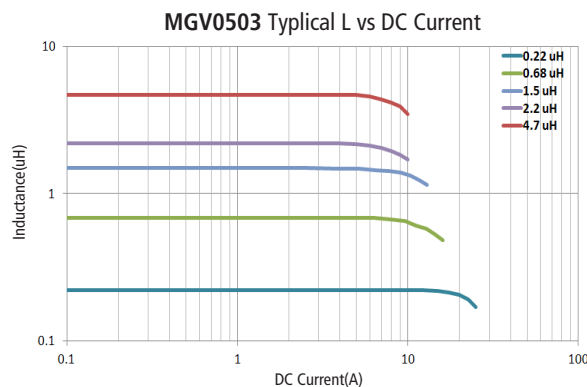
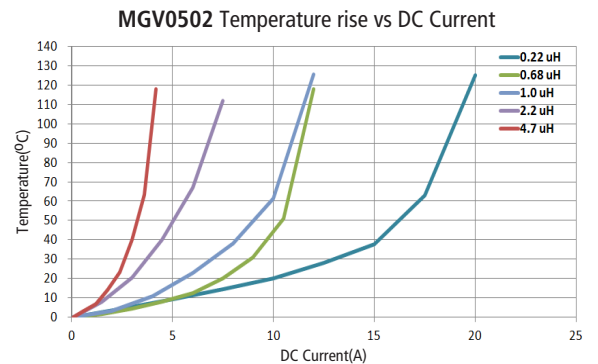
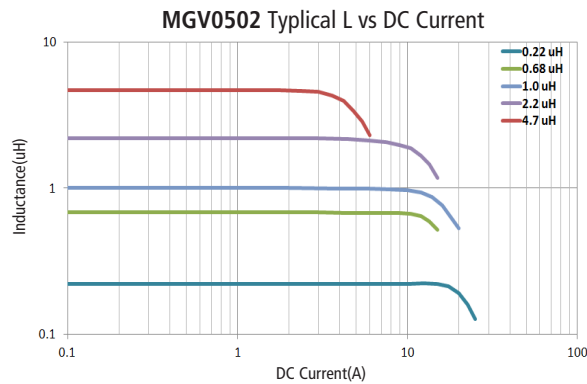

MGV SERIES 0602 / 0603

ELECTRICAL SPECIFICATIONS

PART NO.	INDUCTANCE (μH) ± 20%	RDC (mΩ) Max	SATURATION CURRENT (A)Max	RMS CURRENT (A)Max
MGV0602R10M-10	0.10	3.50	40.0	18.0
MGV0602R15M-10	0.15	5.20	38.0	15.0
MGV0602R22M-10	0.22	5.70	26.0	14.0
MGV0602R33M-10	0.33	7.00	18.0	12.0
MGV0602R47M-10	0.47	9.30	18.0	11.0
MGV0602R68M-10	0.68	13.90	17.0	9.0
MGV0602R82M-10	0.82	15.90	17.0	8.0
MGV06021R0M-10	1.00	18.30	14.0	7.0
MGV06021R5M-10	1.50	34.00	13.0	4.0
MGV06022R2M-10	2.20	46.00	11.5	3.8
MGV06023R3M-10	3.30	60.10	10.0	3.3
MGV06024R7M-10	4.70	78.00	8.0	3.0
MGV0603R10M-10	0.10	1.70	60.0	32.5
MGV0603R22M-10	0.22	2.80	40.0	23.0
MGV0603R33M-10	0.33	3.90	30.0	20.0
MGV0603R47M-10	0.47	4.20	26.0	17.5
MGV0603R68M-10	0.68	5.50	25.0	15.5
MGV0603R82M-10	0.82	8.00	24.0	13.0
MGV06031R0M-10	1.00	10.00	22.0	11.0
MGV06031R5M-10	1.50	15.00	18.0	9.0
MGV06032R2M-10	2.20	20.00	14.0	8.0
MGV06033R3M-10	3.30	30.00	13.5	6.0
MGV06034R7M-10	4.70	40.00	10.0	5.5
MGV06036R8M-10	6.80	60.00	8.0	4.5
MGV06038R2M-10	8.20	68.00	7.5	4.0
MGV0603100M-10	10.00	105.00	7.0	3.0

TYPICAL ELECTRICAL CHARACTERISTICS

MGV0602 Typical L vs DC Current

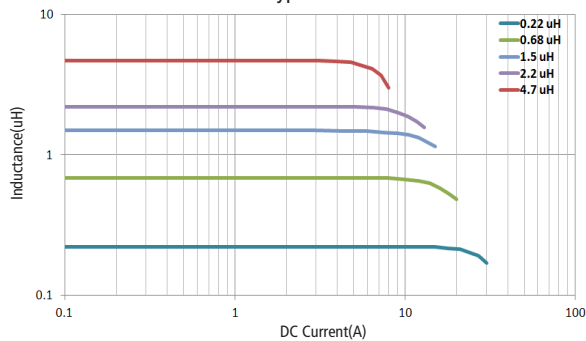

MGV0602 Temperature rise vs DC Current

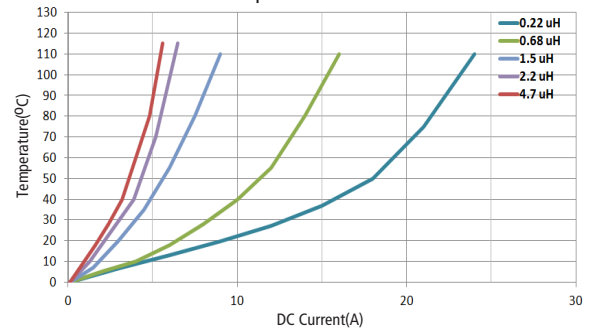

MGV0603 Typical L vs DC Current

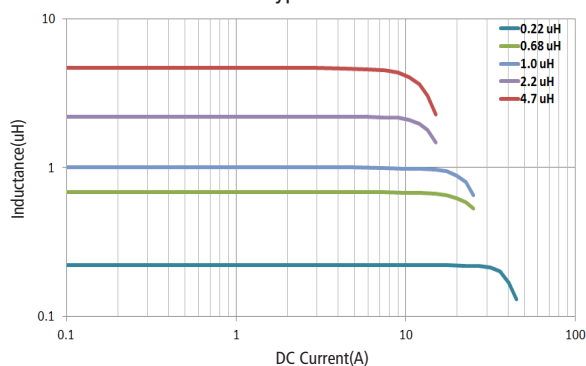

MGV0603 Temperature rise vs DC Current

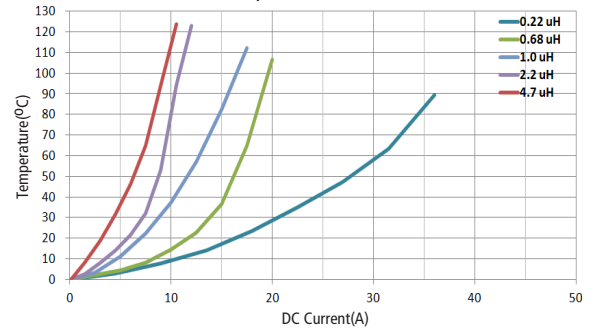

MGV SERIES 0605 / 0625

ELECTRICAL SPECIFICATIONS

PART NO.	INDUCTANCE (μH) ± 20%	RDC (mΩ) Max	SATURATION CURRENT (A)Max	RMS CURRENT (A)Max
MGV0605R56M-10	0.56	3.60	18.0	20.0
MGV0605R68M-10	0.68	4.50	17.0	18.0
MGV0605R82M-10	0.82	4.90	16.0	16.5
MGV06051R0M-10	1.00	6.50	15.0	13.0
MGV06051R5M-10	1.50	9.00	13.0	12.0
MGV06052R2M-10	2.20	13.60	12.0	11.0
MGV06053R3M-10	3.30	20.90	9.0	8.5
MGV06054R7M-10	4.70	30.30	7.0	6.5
MGV06055R6M-10	5.60	34.40	7.0	6.0
MGV06056R8M-10	6.80	44.60	6.0	5.5
MGV06058R2M-10	8.20	50.70	5.5	5.5
MGV0605100M-10	10.00	71.30	5.3	4.5
MGV0625R10M-10	0.10	1.70	50.0	30.0
MGV0625R22M-10	0.22	3.20	34.0	21.0
MGV0625R33M-10	0.33	4.10	22.0	18.0
MGV0625R47M-10	0.47	6.50	21.0	13.5
MGV0625R68M-10	0.68	9.40	18.0	11.0
MGV0625R82M-10	0.82	11.80	17.0	10.0
MGV06251R0M-10	1.00	14.20	16.0	9.0
MGV06251R5M-10	1.50	21.20	15.0	7.5
MGV06252R2M-10	2.20	34.00	14.0	6.5
MGV06253R3M-10	3.30	51.60	13.0	5.0
MGV06254R7M-10	4.70	63.00	10.0	4.5
MGV06256R8M-10	6.80	95.00	9.0	3.5
MGV06258R2M-10	8.20	106.00	8.0	3.0
MGV0625100M-10	10.00	129.00	7.0	2.5

TYPICAL ELECTRICAL CHARACTERISTICS

MGV0605 Typical L vs DC Current

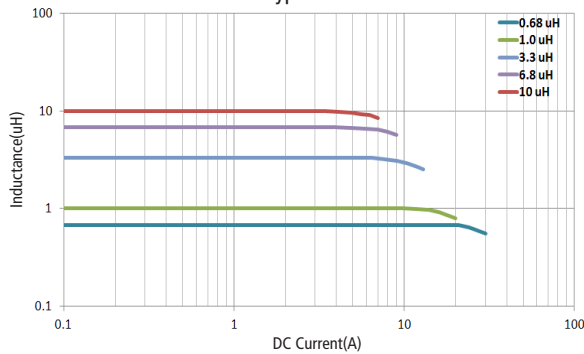

MGV0605 Temperature rise vs DC Current

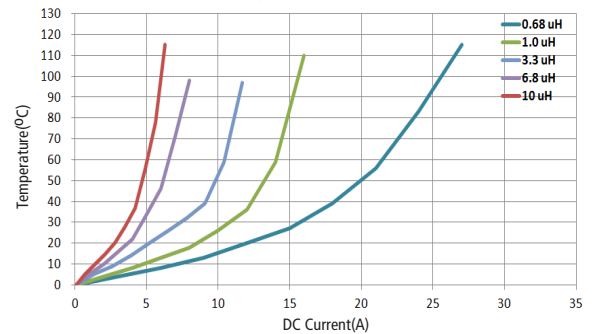

MGV0625 Typical L vs DC Current

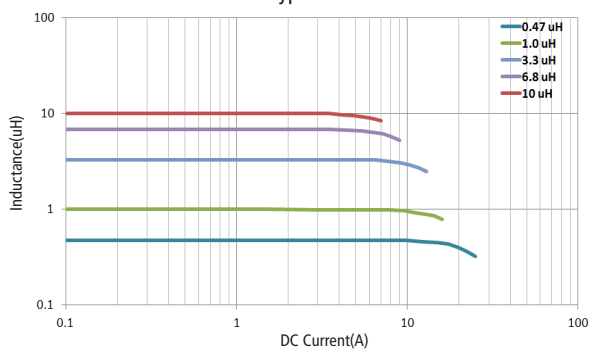

MGV0625 Temperature rise vs DC Current

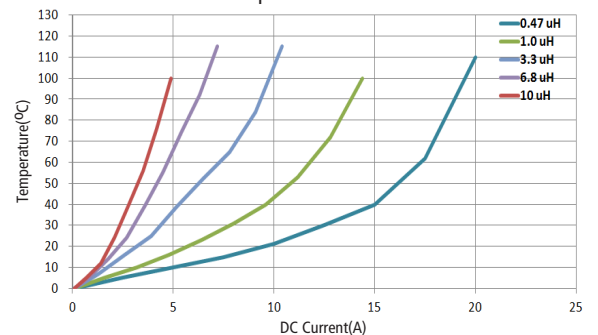

MGV SERIES 1004 / 1203

ELECTRICAL SPECIFICATIONS

PART NO.	INDUCTANCE (μH) ± 20%	RDC (mΩ) Max	SATURATION CURRENT (A)Max	RMS CURRENT (A)Max
MGV1004R19M-10	0.19	0.95	90.0	40.0
MGV1004R36M-10	0.36	1.40	60.0	31.5
MGV1004R47M-10	0.47	1.60	53.0	28.5
MGV1004R56M-10	0.56	1.80	49.0	27.5
MGV10041R0M-10	1.00	4.10	36.0	17.5
MGV10041R5M-10	1.50	5.80	27.5	15.0
MGV10042R2M-10	2.20	9.00	25.6	12.0
MGV10043R3M-10	3.30	11.80	18.6	10.0
MGV10044R7M-10	4.70	16.50	17.0	9.5
MGV10045R6M-10	5.60	19.30	16.0	8.5
MGV10046R8M-10	6.80	23.30	13.5	8.0
MGV1004100M-10	10.00	36.50	12.0	6.8
MGV1203R10M-10	0.10	0.96	84.0	43.0
MGV1203R15M-10	0.15	1.20	75.0	41.0
MGV1203R22M-10	0.22	1.30	65.0	38.5
MGV1203R33M-10	0.33	1.50	62.0	36.5
MGV1203R47M-10	0.47	2.00	55.0	32.0
MGV1203R60M-10	0.60	2.20	51.0	29.0
MGV1203R68M-10	0.68	2.50	49.0	28.0
MGV1203R82M-10	0.82	3.00	44.0	25.0
MGV12031R0M-10	1.00	3.50	40.0	24.0
MGV12031R5M-10	1.50	5.50	35.0	19.0
MGV12031R8M-10	1.80	7.00	30.0	16.5
MGV12032R2M-10	2.20	8.00	29.0	16.0
MGV12033R3M-10	3.30	12.00	27.0	12.0
MGV12034R7M-10	4.70	15.00	24.0	10.0
MGV12035R6M-10	5.60	19.00	19.0	9.5
MGV12036R8M-10	6.80	22.00	18.0	9.0
MGV12038R2M-10	8.20	28.00	16.0	8.5
MGV1203100M-10	10.00	34.00	14.0	7.0

TYPICAL ELECTRICAL CHARACTERISTICS

MGV1004 Typical L vs DC Current

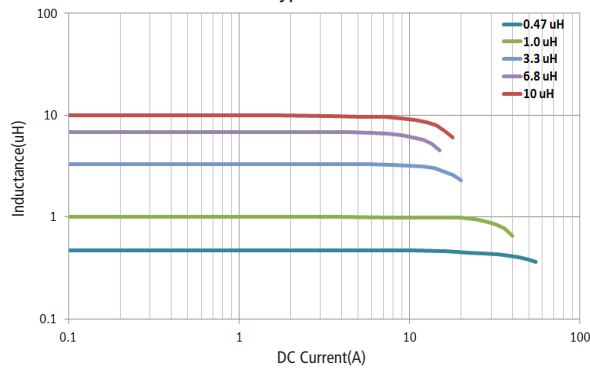

MGV1004 Temperature rise vs DC Current

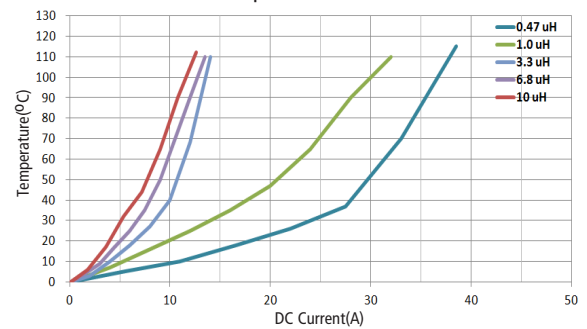

MGV1203 Typical L vs DC Current

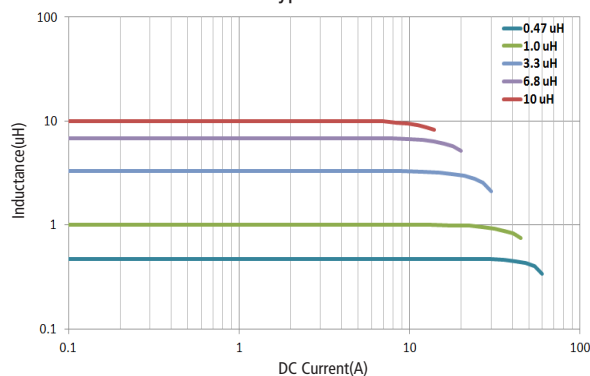

MGV1203 Temperature rise vs DC Current

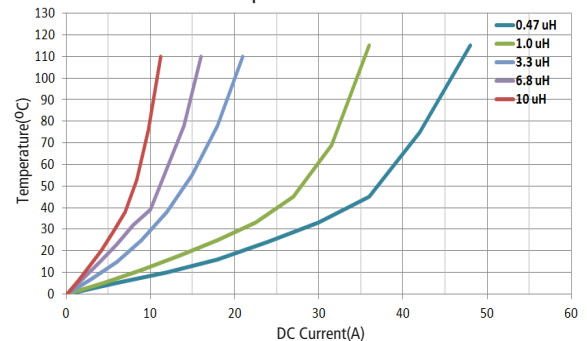

MGV SERIES 1205/1207

ELECTRICAL SPECIFICATIONS

PART NO.	INDUCTANCE (μ H) \pm 20%	RDC (m Ω) Max	SATURATION CURRENT (A)Max	RMS CURRENT (A)Max
MGV1205R10M-10	0.10	0.60	118.0	55.0
MGV1205R22M-10	0.22	0.80	110.0	51.0
MGV1205R33M-10	0.33	1.10	80.0	42.0
MGV1205R47M-10	0.47	1.30	65.0	38.0
MGV1205R56M-10	0.56	1.50	55.0	36.0
MGV1205R68M-10	0.68	1.70	54.0	34.0
MGV1205R82M-10	0.82	2.30	53.0	31.0
MGV12051R0M-10	1.00	2.50	50.0	29.0
MGV12051R5M-10	1.50	4.10	48.0	23.0
MGV12051R8M-10	1.80	4.90	40.0	19.0
MGV12052R2M-10	2.20	5.50	32.0	20.0
MGV12053R3M-10	3.30	9.20	32.0	15.0
MGV12054R7M-10	4.70	15.00	27.0	12.0
MGV12055R6M-10	5.60	16.50	22.0	11.5
MGV12056R8M-10	6.80	18.50	21.0	11.0
MGV12057R8M-10	7.80	20.50	18.0	10.0
MGV12058R2M-10	8.20	22.50	18.0	9.5
MGV1205100M-10	10.00	25.50	16.0	9.0
MGV1207R10M-10	0.10	0.50	120.0	60.0
MGV1207R15M-10	0.15	0.60	118.0	55.0
MGV1207R22M-10	0.22	0.70	112.0	53.0
MGV1207R30M-10	0.30	0.80	72.0	48.0
MGV1207R33M-10	0.33	0.90	65.0	46.0
MGV1207R40M-10	0.40	1.00	64.0	44.0
MGV1207R47M-10	0.47	1.20	63.0	41.0
MGV1207R56M-10	0.56	1.40	62.0	37.0
MGV1207R68M-10	0.68	1.60	60.0	35.0
MGV1207R82M-10	0.82	1.90	50.0	33.0
MGV12071R0M-10	1.00	2.00	49.0	32.0
MGV12071R2M-10	1.20	2.50	48.0	30.0
MGV12071R5M-10	1.50	3.00	45.0	27.0
MGV12071R8M-10	1.80	3.20	41.0	24.0
MGV12072R2M-10	2.20	4.20	40.0	22.0
MGV12073R3M-10	3.30	6.80	35.0	18.0
MGV12074R7M-10	4.70	8.70	32.0	13.5
MGV12075R6M-10	5.60	10.00	32.0	13.5
MGV12076R8M-10	6.80	14.00	16.5	11.5
MGV12078R2M-10	8.20	15.50	16.0	10.5
MGV1207100M-10	10.00	17.20	15.5	10.0

MGV SERIES 1205/1207

TYPICAL ELECTRICAL CHARACTERISTICS

MGV1205 Typical L vs DC Current

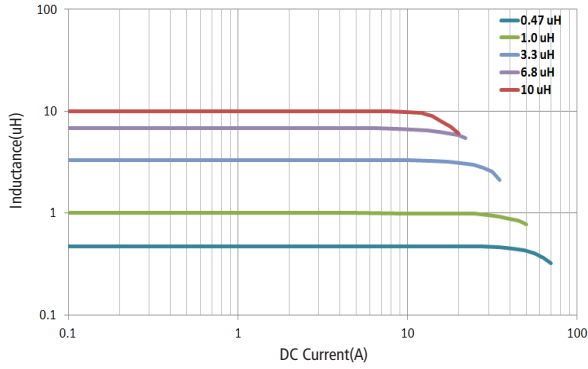

MGV1205 Temperature rise vs DC Current

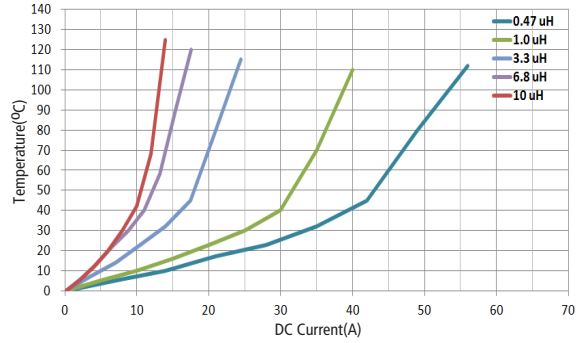

MGV1207 Typical L vs DC Current

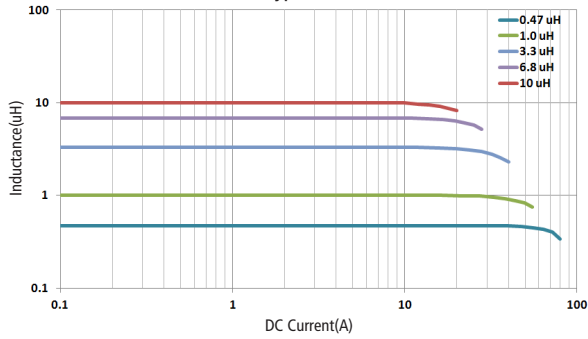

MGV1207 Temperature rise vs DC Current

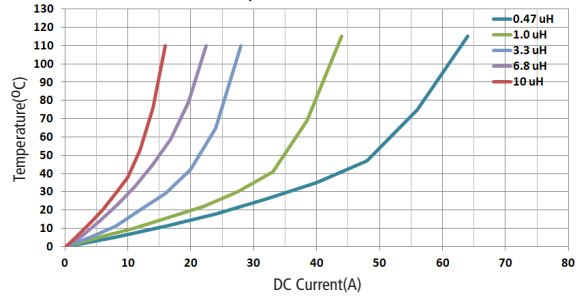

MGV SERIES PACKAGING INFORMATION

STANDARD QUANTITY

SERIES	TAPE AND REEL QUANTITY (PCS)
MGV0402	3500
MGV0502	3000
MGV0503	2500
MGV0602	2000
MGV0603	1500
MGV0605	800
MGV0625	2000
MGV1004	1000
MGV1203	1000
MGV1205	500
MGV1207	500

TAPING DIMENSIONS

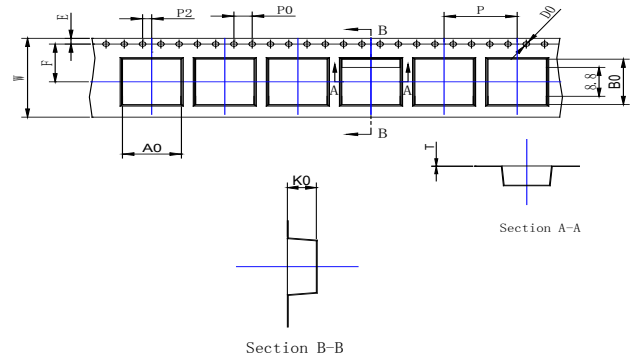

SERIES (UNIT: mm)	W	A ₀	B ₀	K ₀	P	F	E	P ₀	P ₂	T
MGV0402	12±0.3	4.8±0.1	4.4±0.1	2.1±0.1	8.0±0.3	5.5±0.1	1.75±0.1	4±0.1	2±0.1	0.35±0.05
MGV0502		5.75±0.1	5.3±0.1	3.1±0.1						
MGV0503				2.1±0.1						
MGV0602	16±0.3	6.9±0.1	7.4±0.1	3.1±0.1	12±0.3	7.5±0.1				
MGV0603				5.1±0.1						
MGV0605				2.6±0.1						
MGV0625										
MGV1004	24±0.3	10.3±0.1	11.2±0.1	4.1±0.1	16±0.3	11.5±0.1				
MGV1203		3.6±0.1								
MGV1205		12.8±0.1	13.8±0.1	5.1±0.1						
MGV1207		6.6±0.1								

REEL DIMENSIONS

SERIES (UNIT: mm)	TYPE	A	B	C	D
MGV0402	13' x 16	12± 0.5	100 ± 2	13.5 ± 0.5	330
MGV0502					
MGV0503					
MGV0602		16 ± 0.5			
MGV0603					
MGV0605					
MGV0625					
MGV1004	13'x24	24±0.5			
MGV1203					
MGV1205					
MGV1207					

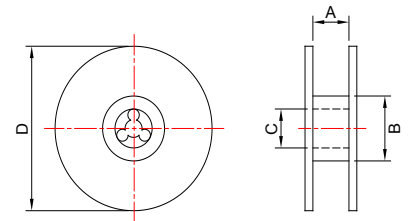

SAMPLE KIT LISTS

KIT NO:K-530 MGV IND

It contains parts of each single series as following lists

SERIES	PART NUMBER QTY	SAMPLE QTY / PN
MGV0402	8	3
MGV0502	9	3
MGV0503	11	3
MGV0602	12	3
MGV0603	14	3
MGV0605	12	3
MGV0625	14	3
MGV1004	12	3
MGV1203	18	3
MGV1205	18	3
MGV1207	21	3



Americas: +1 800 634.2673 Option 1

Europe: +420 488.575277

Asia: +86 757.2563.8860

www.lairdtech.com

SIP-CAT-MGV SERIES 0813

Any information furnished by Laird Technologies, Inc. and its agents is believed to be accurate and reliable. All specifications are subject to change without notice. Responsibility for the use and application of Laird Technologies materials rests with the end user. Laird Technologies makes no warranties as to the fitness, merchantability, suitability or non-infringement of any Laird Technologies materials or products for any specific or general uses. Laird Technologies shall not be liable for incidental or consequential damages of any kind. All Laird Technologies products are sold pursuant to the Laird Technologies' Terms and Conditions of sale in effect from time to time, a copy of which will be furnished upon request. © Copyright 2013 Laird Technologies, Inc. All Rights Reserved. Laird, Laird Technologies, the Laird Technologies Logo, and other marks are trade marks or registered trade marks of Laird Technologies, Inc. or an affiliate company thereof. Other product or service names may be the property of third parties. Nothing herein provides a license under any Laird Technologies or any third party intellectual property rights. Version A01