

1.27 mm SMT Connectors for
Board-to-Board Applications

ONE27. ■



One27® Overview

Compact, Rugged, Versatile

The One27® range offers a high level of flexibility and at the same time reliable connectors for a number of board-to-board applications. The product family is based on a pitch of 1.27 mm, offers both straight and angled types as well as connections with ribbon cable, and is available in pin counts from 12 to 80 pins.

The connectors are compatible with currently available products and their performance in tests has been excellent.

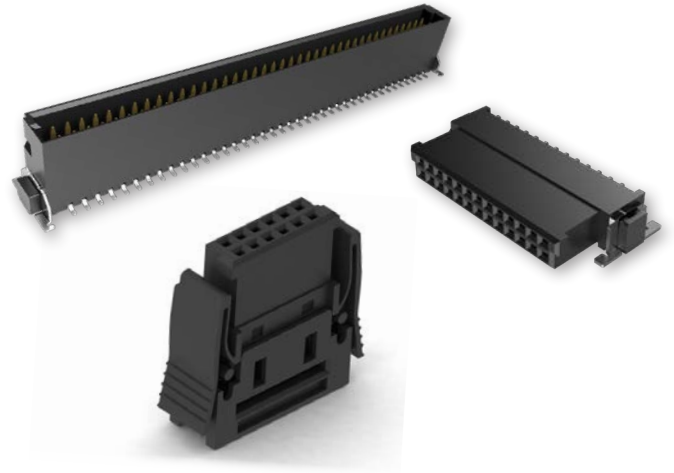

SMT



Parallel



Horizontal



Perpendicular



Cable



High Density

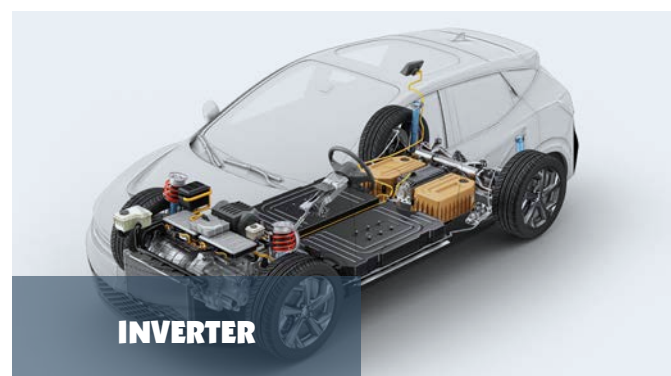
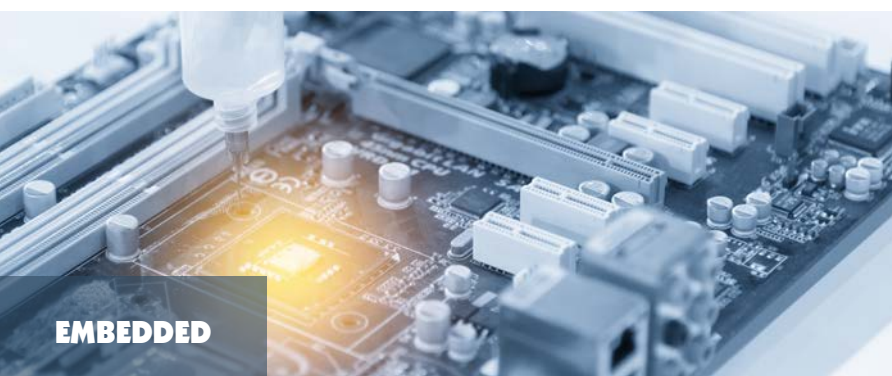
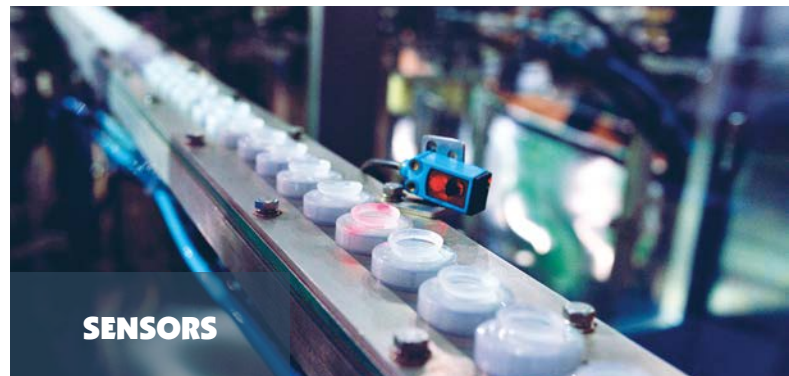

Key Features:

- 1.4 A Current carrying capacity
- 500 mating cycles
- Highest contact reliability
- Tested compatibility with other suppliers
- Female IDC available individually or assembled with cable

Applications:

- Board-to-Board (mezzanine) from 8 mm to 20 mm
- Parallel, perpendicular and horizontal connections
- IDC connectability with ribbon cable

Our One27 Video:



<https://youtu.be/6doPp-7ea88>



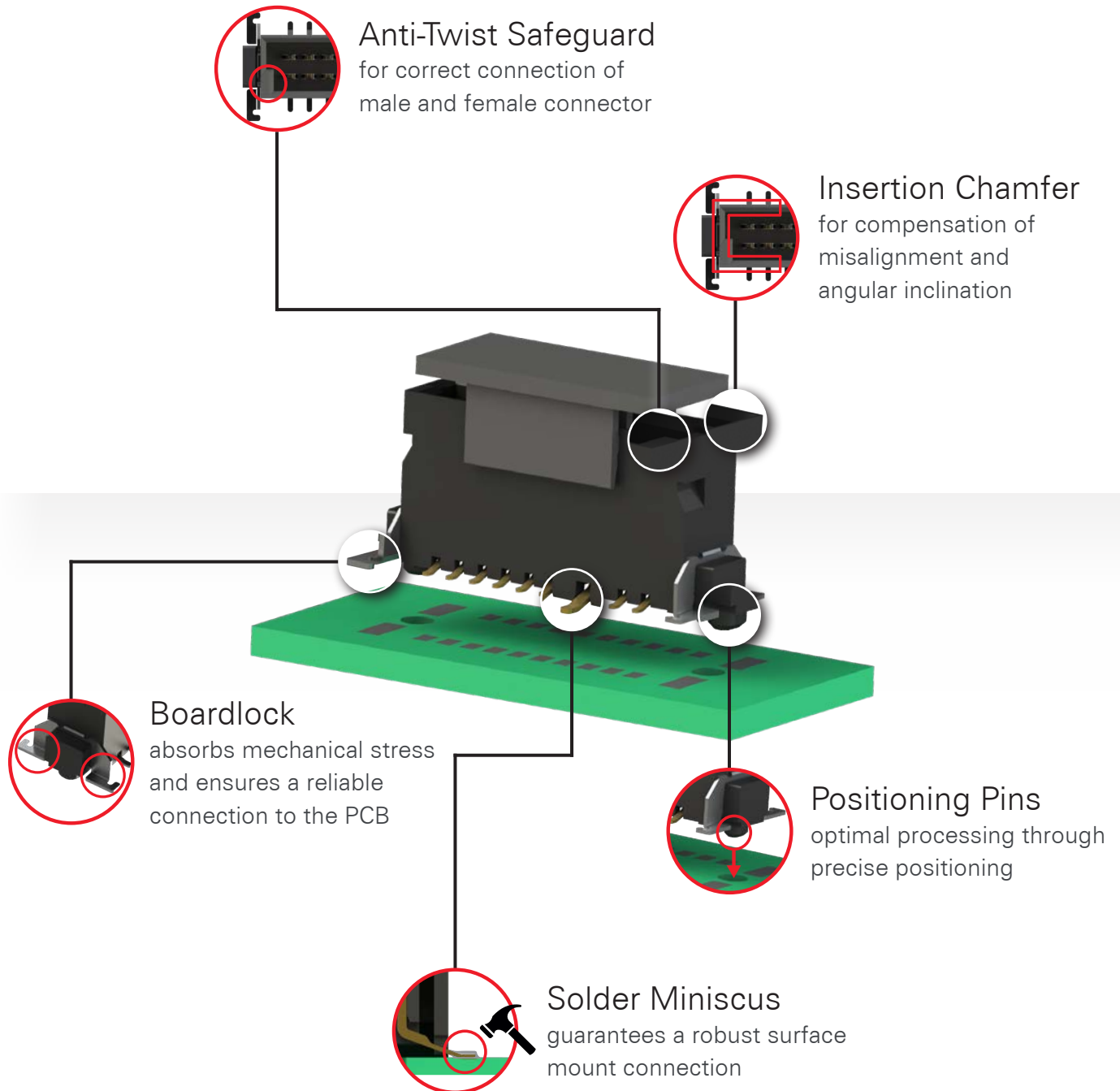

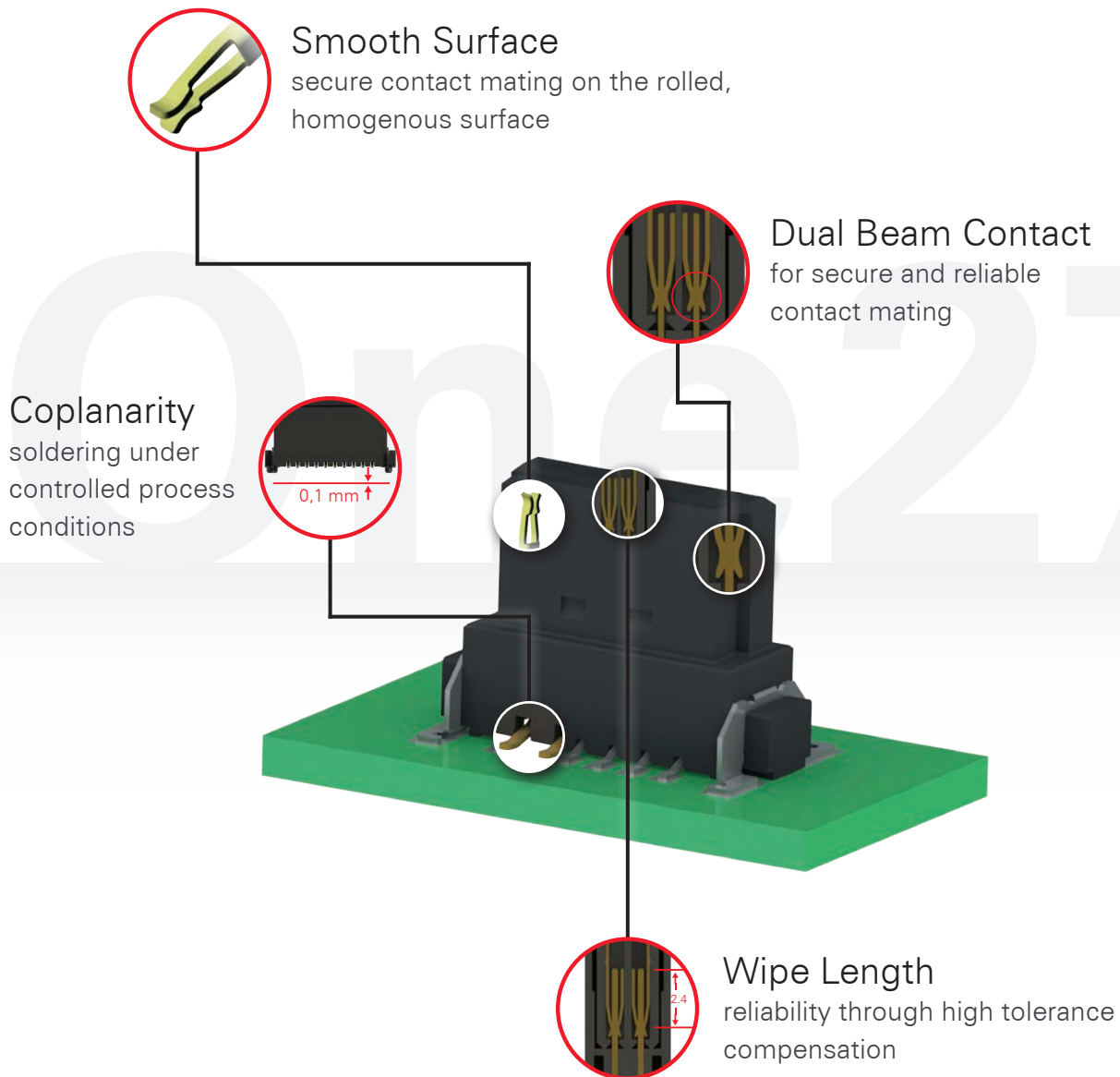

Other features:

- Test reports available for compatibility with other connectors on the market
- Tape & reel packaging for automated assembly
- Custom variants available on request

One27®

Dimensions

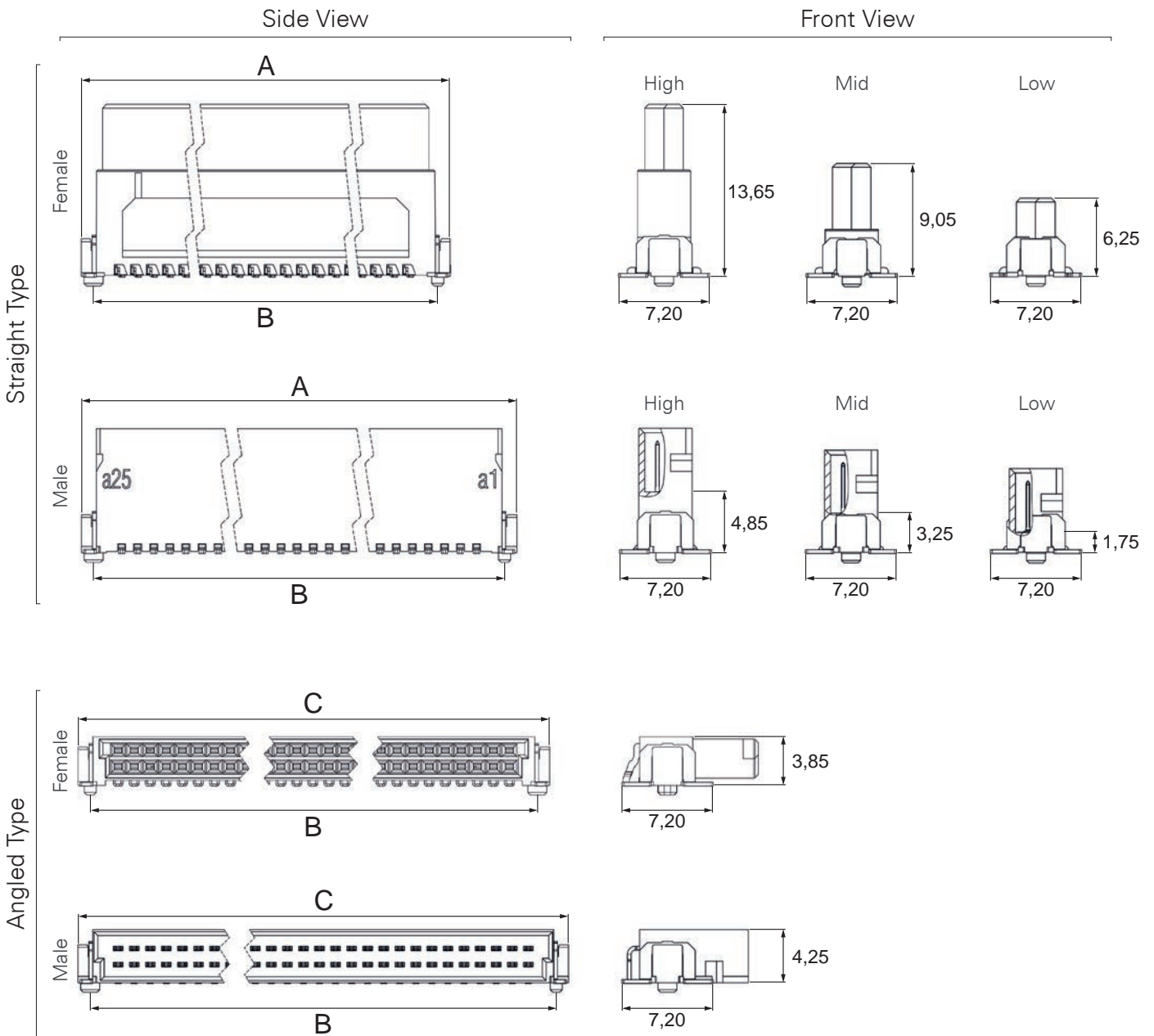

Connector lengths in mm:

Polzahl	A	B	C
12	12,70	10,77	12,71
16	15,24	13,31	15,25
20	17,78	15,85	17,79
26	21,59	19,66	21,60
32	25,40	23,47	25,41
40	30,48	28,55	30,49
50	36,83	34,90	36,84
68	48,26	46,33	48,27
80	55,88	53,95	55,89



Detailed drawings as well as a layout recommendation are available on www.ept.de after selecting the corresponding article.

Basics		
Number of pins	12 / 16 / 20 / 26 / 32 / 40 / 50 / 68 / 80	
Termination	SMT	
Operating temperature range	-55°C to +125°C	

Material		
Insulator material	LCP	
CTI	175	IEC 60112
Contact material	Copper alloy	
Contact surface	Au over PdNi over Ni Au over NiP over Ni	
Termination area	Sn	

Mechanical		
Pitch	1.27 mm	
Mating force per pin	≤ 0.5 N	
Separating force per pin	≥ 0.1 N	
Durability	Performance lv. I: 500 mating cycles	IEC 60512-9-1
Coplanarity	≤ 0.1 mm	
Vibration, sinusoidal	10 - 2000 Hz, 20 g	IEC 60512-6-4
Contact mating problems if vibrations occur, sinusoidal	< 1 μs	IEC 60512-2-5
Shock, semi-sinusoidal	50 g, 11 ms	IEC 60512-6-3
Contact mating problems if shocks occur, semi-sinusoidal	< 1 μs	IEC 60512-2-5

Electrical		
Operational current	max. 1.4 A at 20°C (50 pins)	IEC 60512-5-2
Contact resistance	max. 25 mΩ max. 10 mΩ (female IDC + cable)	IEC 60512-2-1
Clearance and creepage	min. 0.4 mm	
Insulation resistance	max. 10 GΩ	IEC 60512-3-1
Test voltage	500 VAC	IEC 60512-4-1
Data transfer rate	3 Gbit/s	

Processing		
Soldering temperature	max. SMT reflow soldering temp. 20 - 40 s bei 260°C	JEDEC J-STD-020
MSL	1	JEDEC J-STD-020
Packaging	Tape & Reel, Tray (female IDC)	
Assembly	Pick and place	

Approval		
UL file	E130314	
Environment	RoHS compliant	



Detailed test reports are available at www.ept.de after selecting the corresponding article.

Allowed Misalignment Tolerances

longitudinal: ± 0.7 mm

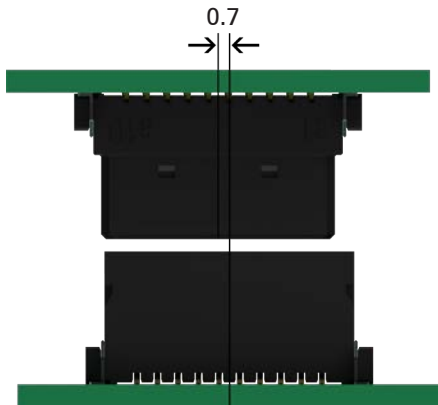

transverse: ± 0.7 mm



Allowed Angular Inclination Tolerances

longitudinal: $\pm 4^\circ$

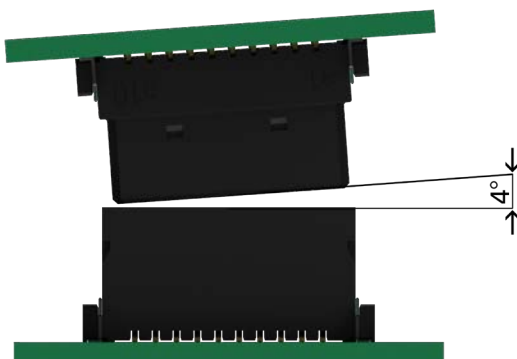

transverse: $\pm 2^\circ$

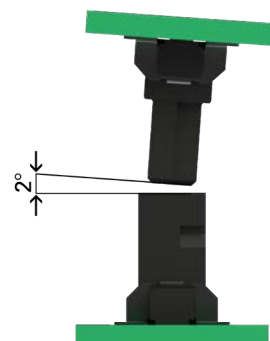

Locking of One27 IDC-Female Connectors

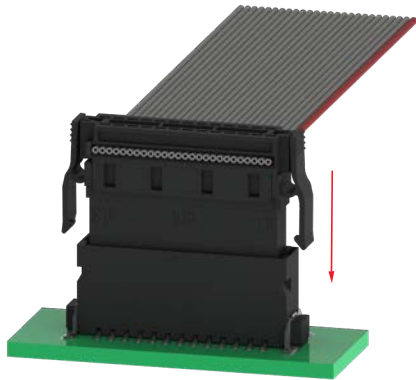

While inserting the IDC-female connector into the male connector, the snap-fits lock automatically into their slots.

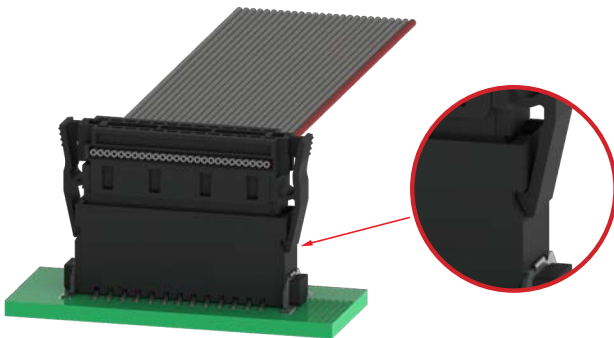

If the snap-fits are visibly locked into their slots, the connection between female and male connector is secured.

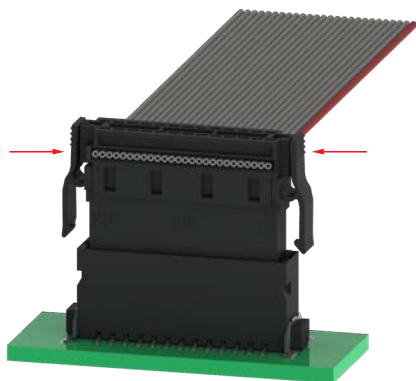

To disconnect simply press the snap-fits together.

Part Numbers for B-t-B Applications



Parallel Connector Pairs

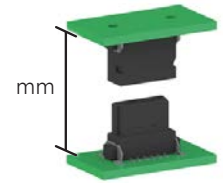

Board-to-Board Distance in mm

8	9	10	11	12	13	14	15	16	17	18	19	20
A 8.0 - 9.5	B 9.5 - 11.0	C 11.1 - 12.6				F 13.9 - 15.4	G 15.4 - 16.9	H 16.9 - 18.4		I 18.5 - 20.0		
		D 10.8 - 12.3	E 12.3 - 13.8									



Please refer to the connector combinations table on page 11

Part Number Key

Type

- 403 Male
- 404 Female

Profile

- 51 Angled
- 52 Low
- 53 Mid
- 54 High







X X X - **X X 0** **NN** - **5 1**

12, 16, 20, 26, 32, 40, 50, 68, 80

Pins



Connector Combinations Table

	Female		Male	
Pairing		Part number		Part number
A	low	 404-520NN-51	low	 403-520NN-51
B	low	 404-520NN-51	mid	 403-530NN-51
C	low	 404-520NN-51	high	 403-540NN-51
D	mid	 404-530NN-51	low	 403-520NN-51
E	mid	 404-530NN-51	mid	 403-530NN-51
F	mid	 404-530NN-51	high	 403-540NN-51
G	high	 404-540NN-51	low	 403-520NN-51
H	high	 404-540NN-51	mid	 403-530NN-51
I	high	 404-540NN-51	high	 403-540NN-51
Packaging Tape & Reel low & mid		280 pcs.		280 pcs.
Packaging Tape & Reel high		170 pcs.		250 pcs.



Available Options:

- Custom pin counts
- Other performance levels
- Custom variants

Part Numbers for B-t-B Applications

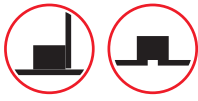

Angled Connector Pairs

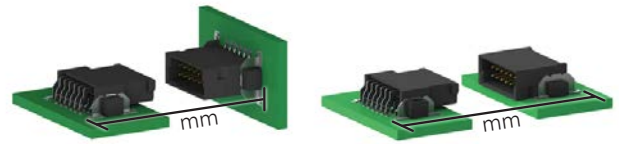

Required Installation Space in mm

11	12	13	14	15	16	17	18	19	20
A 11.25 - 12.75			C 14.05 - 15.55		E 15.65 - 17.15			F 18.65 - 20.15	
	B 12.55 - 14.05		D 14.05 - 15.55						



Please refer to the connector combinations table on page 13

Part Number Key

Type

- 403 Male
- 404 Female

Profile

- 51 Angled
- 52 Low
- 53 Mid
- 54 High

X X X - **X X 0** **NN** - **5 1**





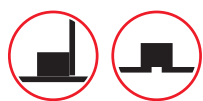







12, 16, 20, 26, 32, 40, 50, 68, 80



Pins



Connector Combinations Table

Female	Male
--------	------

Pairing 90°	Part number		Part number	
A	low	 404-520NN-51	90°	 403-510NN-51
B	90°	 404-510NN-51	low	 403-520NN-51
C	mid	 404-530NN-51	90°	 403-510NN-51
D	90°	 404-510NN-51	mid	 403-530NN-51
E	90°	 404-510NN-51	high	 403-540NN-51
F	high	 404-540NN-51	90°	 403-510NN-51

Pairing horizontal	Part number		Part number	
Horizontal 15.65 - 17.15 mm	90°	 404-510NN-51	90°	 403-510NN-51

Packaging Tape & Reel low & mid	280 pcs.	280 pcs.
Packaging Tape & Reel high	170 pcs.	250 pcs.
Packaging Tape & Reel angled	560 pcs.	560 pcs.



Available Options:

- Custom pin counts
- Other performance levels
- Custom variants

One27 Female IDC Pre-Assembled with Cable

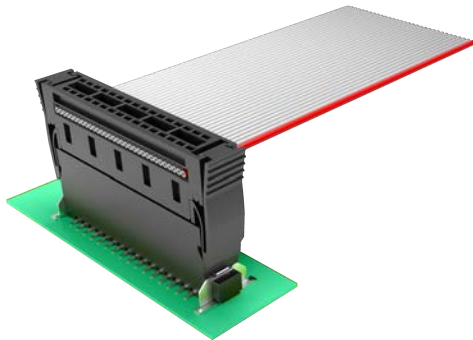

- Alignment of the connectors, pin count and cable length freely selectable
- Cable AWG 30/7 - cross section 0.06 mm²
- Insulation displacement connection technology (IDC)
- Cable type PVC: -30°C to + 105°C (at rest)
- Colored wire on a1
- IDC female connector single or with cable assembled available

Part Number Key for Cable Assembly

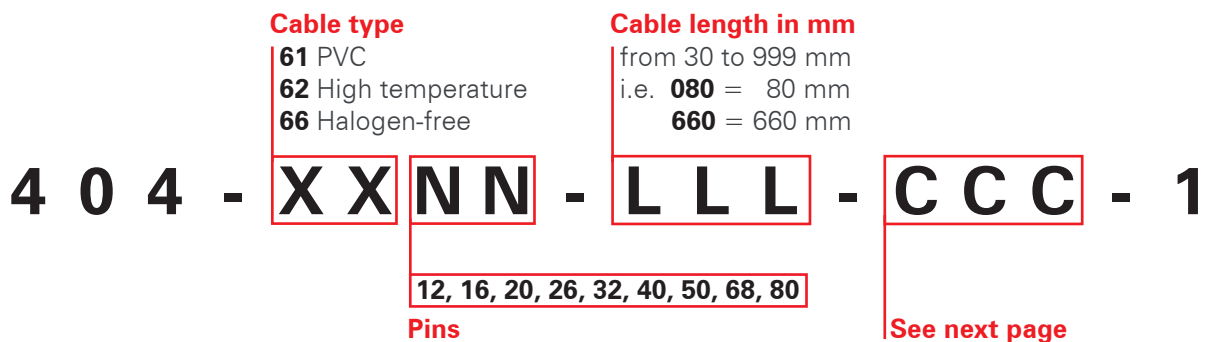

Dimensions

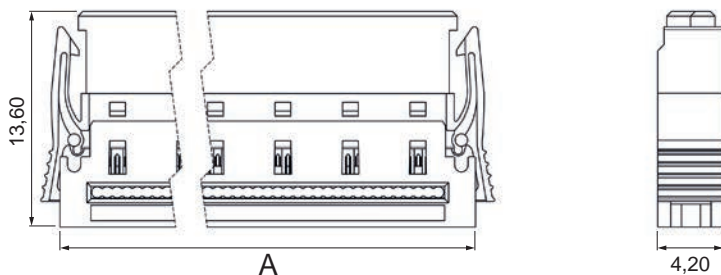

Connector lengths in mm:

Part number	Pins	A
404-59012-61	12	5
404-59016-61	16	7
404-59020-61	20	9
404-59026-61	26	12
404-59032-61	32	15
404-59040-61	40	19
404-59050-61	50	24
404-59068-61	68	33
404-59080-61	80	39



Detailed drawings as well as a layout recommendation are available on www.ept.de after selecting the corresponding article.

Assembled version 100

Part number
404-6XNN-LLL-100-1

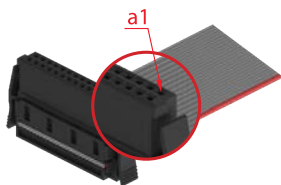

Assembled version 400

Part number
404-6XNN-LLL-400-1

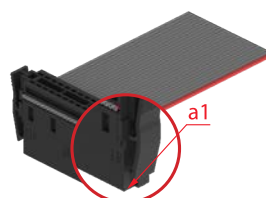

Assembled version 120

Part number
404-6XNN-LLL-120-1

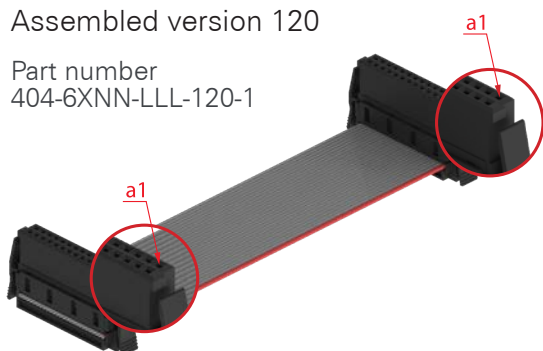

Assembled version 140

Part number
404-6XNN-LLL-140-1

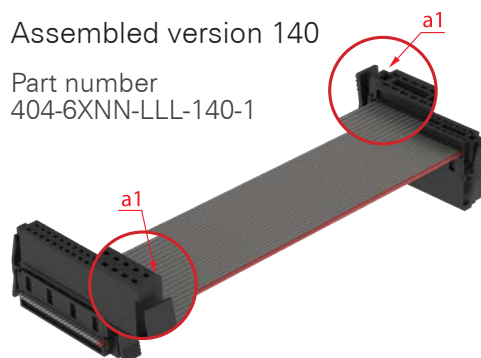

Assembled version 110

Part number
404-6XNN-LLL-110-1

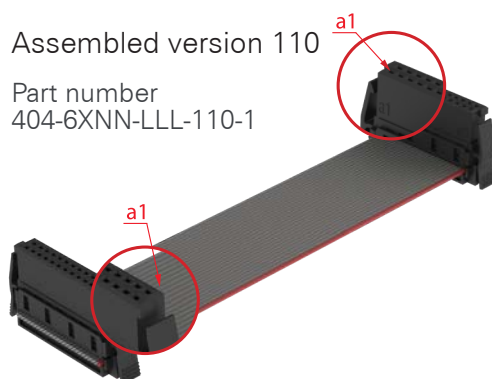

Assembled version 420

Part number
404-6XNN-LLL-420-1

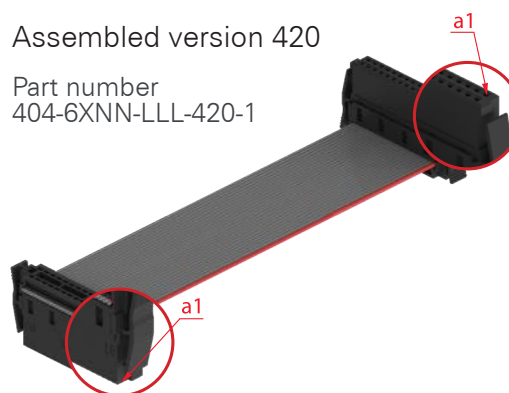

Assembled version 440

Part number
404-6XNN-LLL-440-1

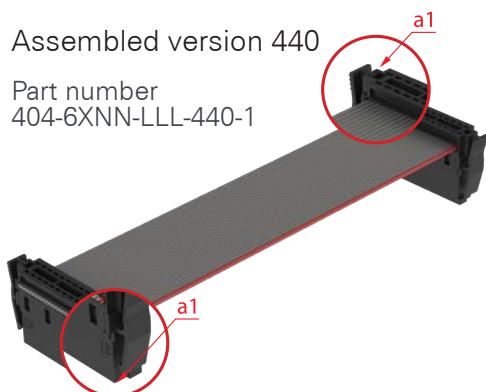

Assembled version 130

Part number
404-6XNN-LLL-130-1

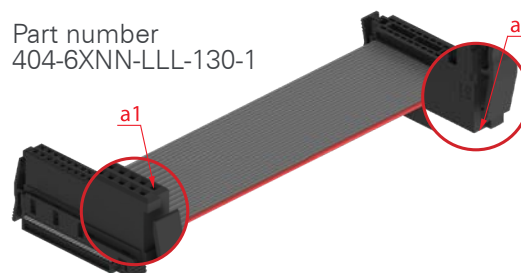

On request we can also provide other cable assemblies

Fast and Simple

You can receive product samples from ept quickly, easily and free of charge. Either with a few easy steps on www.ept.de or by contacting us directly under +49-8861-2501-0 (recommended for special features, such as modifications).

For detailed coordination as well as individual consultation, you can choose between our sales representative in your area, our service representative in Peiting or a local sales partner or distributor.

Order your product samples here:

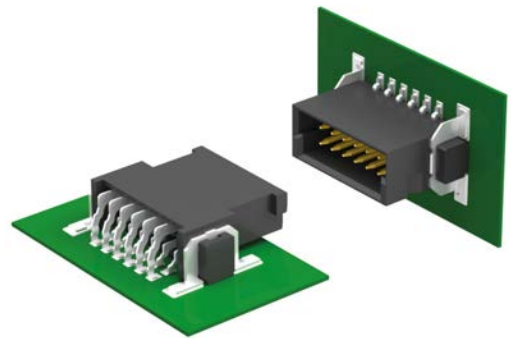

One Stop Supplier

ept is a German quality supplier with sophisticated products in the field of electrical connectivity. Our products and capabilities are used in high-quality and demanding applications such as industrial automation, healthcare, measurement and traffic technology as well as automotive electronics.

At six locations worldwide, connectors are manufactured in-house using highly automated processes across four manufacturing steps (stamping, electroplating injection molding and assembly). Over five decades, we have formed trusting and successful partnerships with our customers, who are at the center of everything we do.

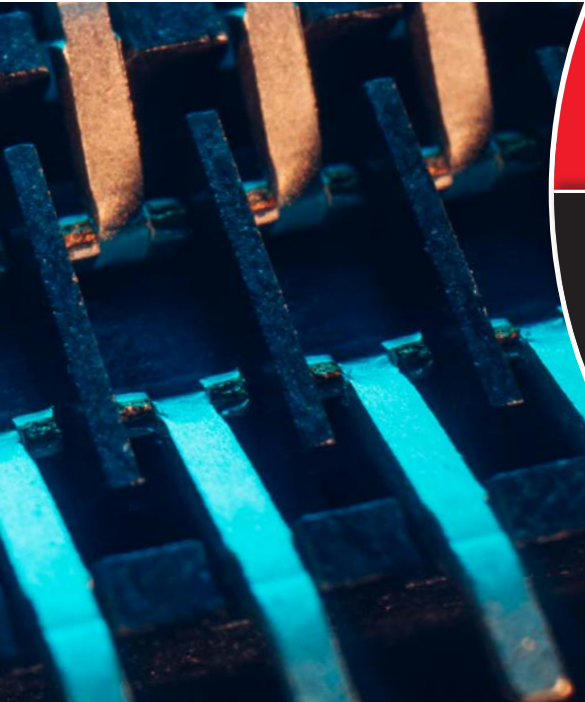



ept GmbH

tel. +49 (0) 8861 / 2501 0

fax +49 (0) 8861 / 5507

sales@ept.de

Bergwerkstr. 50

86971 Peiting, Germany

Other Locations

Buching, Germany

Augsburg, Germany

Habartov, Czech Republic

South Chesterfield, USA

Shanghai, China

Distributors Worldwide

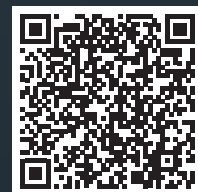

The information contained, including drawings and illustrations intended for illustrative purposes only, is deemed reliable. ept does not, however, guarantee its accuracy or completeness and disclaims any liability in connection with its use. ept's obligations are limited to the information contained in the General Terms and Conditions of Sale, which are available at www.ept.de.

Users of ept's products should determine through a self-performed evaluation whether the products used are suitable for the intended application in each case.