

DC/DC Converter

SURF1D_QB Series



SCHMID-M

50W/75W/100W, wide input voltage,
isolated & regulated single output
DC-DC converter

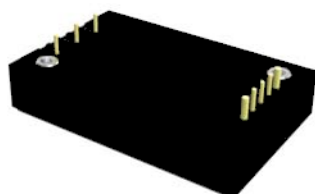

FEATURES

- Wide range of input voltage : 66-160V
- Efficiency up to 92%
- Low no-load power
- Isolation voltage 3000VDC
- Operating temperature range:-40°C~+100°C
- Input under-voltage protection, output over-voltage, over-current, short circuit, over-temperature protection
- International standard: 1/4 brick
- Meets requirements of UL60950 and railway standard EN50155

SURF1D_QB Series is a high performance product designed for the field of railway applications. Output power contains 50W/75W/100W, no min. load requirement, wide input voltage 66-160VDC, which allows the base plate temperature up to 100 °C. Further product features include input under-voltage protection, output over-voltage protection, short circuit protection, over temperature protection, remote control and compensated, output voltage regulation functions. Meets the EN50155 railway standard and UL/EN60950 safety standards. Widely used in the railway system and associated equipment.

Selection Guide

Part No.	Input Voltage (VDC)		Input Voltage (VDC)		Efficiency (% Typ) @ Full Load	Max. Capacitive Load(µF)
	Nominal (Range)	Max.*	Output Voltage(VDC)	Output Current (mA)(Max./Min.)		
SURF1D24QB-50W	110 (66-160)	170	24	2083/0	92	3000
SURF1D24QB-50WH				2083/0		
SURF1D24QB-75W			24	3125/0	92	3000
SURF1D24QB-75WH				3125/0		
SURF1D24QB-100W			24	4167/0	92	3000
SURF1D24QB-100WH				4167/0		

Note: *Absolute maximum rating without damage on the converter, but it isn't recommended.

Input Specifications

Item	Operating Conditions		Min.	Typ.	Max.	Unit
Input Current (no-load / full load)	Nominal input	SURF1D24QB-100W(H)	--	5/988	--	mA
		SURF1D24QB-75W(H)	--	5/741	--	
		SURF1D24QB-50W(H)	--	5/494	--	
Reflected Ripple Current	Nominal input		--	50	--	VDC
Input Surge Voltage (1sec. max.)			-0.7	--	180	
Start-up Threshold Voltage			--	--	66	
Under-voltage Shutdown Voltage			--	55	--	
Start-up Time			--	25	--	mS
Input Filter			Pi filter			
Ctrl*	Module switch on		Ctrl psuspended or connected to TTL high level (3.5-12VDC)			
	Module switch off		Ctrl connected to -Vin or low level (0-1.2VDC)			
	Input current when switched off		--	2	--	mA

Note: * the voltage of Ctrl pin is relative to input pin -Vin.

Output Specifications

Item	Operating Conditions	Min.	Typ.	Max.	Unit
Output Voltage Accuracy	Nominal input, 10%-100% load	--	--	±2	%
Line Regulation	Full load, the input voltage is from low to high	--	--	±0.3	
Load Regulation	Nominal input, 10%-100% load	--	--	±0.5	

DC/DC Converter

SURF1D_QB Series

Transient Recovery Time	25% load step change	--	300	500	μs
Transient Response Deviation		--	±3	±5	%
Temperature Drift Coefficient	Full load	--	--	±0.03	%/°C
Ripple & Noise *	20MHz bandwidth	--	100	300	mVp-p
Output voltage Regulated range(Trim)		-10	--	10	%
Output voltage remote compensation(Sense)		--	--	5	
Output Over-voltage Protection	Input voltage range	110	--	140	%Vo
Output Over-current Protection		110	130	180	%Io
Output Short circuit Protection		Continuous			

Note: * The measuring method of ripple and noise, please refer to Fig. 1 .

General Specifications

Item	Operating Conditions	Min.	Typ.	Max.	Unit
Insulation Voltage	Input-output	3000	--	--	VDC
	Input-case	1500	--	--	
	Output-case	1500	--	--	
Insulation Resistance	Input-output, insulation voltage 500VDC	1000	--	--	MΩ
Isolation Capacitance	Input-output, 100KHz/0.1V	--	2200	--	pF
Switching Frequency	PFM mode	--	220	--	KHz
MTBF	MIL-HDBK-217F@25°C	500	--	--	K hours

Environmental Specifications

Item	Operating Conditions	Min.	Max.	Unit	
Base- Plate Temperature Range	Within the operating temperature curve	-40	100	°C	
Over-temperature Protection	Base- Plate Temperature	--	115		
Thermal Resistance	SURF1DxxQB-100W	Natural convection	10.7	--	°C/W
		200LFM convection	6.0	--	
		400LFM convection	5.0	--	
		1000LFM convection	4.0	--	
	SURF1DxxQB-100WH	Natural convection	5.1	--	
		200LFM convection	2.8	--	
		400LFM convection	2.2	--	
		1000LFM convection	1.8	--	
Storage Humidity	Non-condensing	5	95	%RH	
Storage Temperature		-55	125	°C	
Lead Temperature	Welding spot is 1.5mm away from the casing, 10 seconds	--	300		
Cooling Test		EN60068-2-1			
Dry Heat		EN60068-2-2			
Damp heat		EN60068-2-30			
Shock and Vibration Test		IEC/EN61373			

Physical Specifications

Casing Material	Black flame-retardant and heat-resistant plastic (UL94-V0)	
Weight	SURF1D24QB-50W SURF1D24QB-75W SURF1D24QB-100W	46g (Typ.)
	SURF1D24QB-50WH SURF1D24QB-75WH SURF1D24QB-100WH	76g (Typ.)
Cooling method	Natural convection or Forced convection	

DC/DC Converter

SURF1D_QB Series

EMC Specifications

Item	Test Conditions	Test Procedure
EMI	Conducted Disturbance	150KHz-30MHz Class B (see Fig. 2 for recommended circuit)
	Radiated Emission	30MHz-1GHz Class B (see Fig. 2 for recommended circuit)
EMS	Electrostatic Discharge	Contact $\pm 6\text{KV}$, Air $\pm 8\text{KV}$
	Radiation Immunity	10V/m
	Conducted disturbance Immunity	10Vr.m.s
	EFT	$\pm 2\text{KV}$ (5KHz, 100KHz)(see Fig. 2 for recommended circuit)
	Surge Immunity	$\pm 2\text{KV}$ (1.2 μs /50 μs 2 Ω), (see Fig. 2 for recommended circuit)
		$\pm 4\text{KV}$ (1.2 μs /50 μs 12 Ω), (see Fig. 2 for recommended circuit)
Immunities of short interruption	$\pm 1.8\text{KV}$ (5/50 μs 5 Ω), (see Fig. 2 for recommended circuit)	
	100%-0%, 10ms (see Fig. 2 for recommended circuit)	

Efficiency Curves

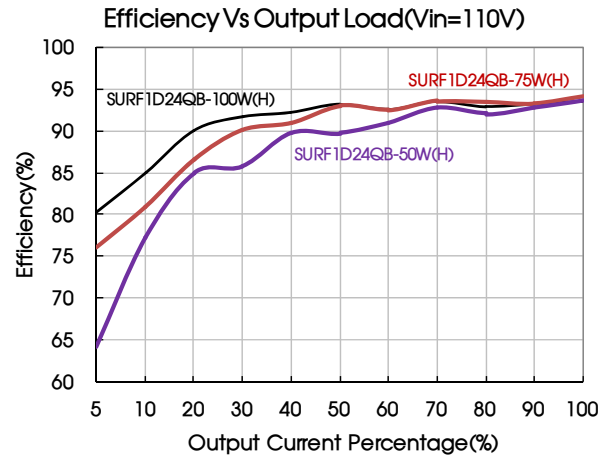
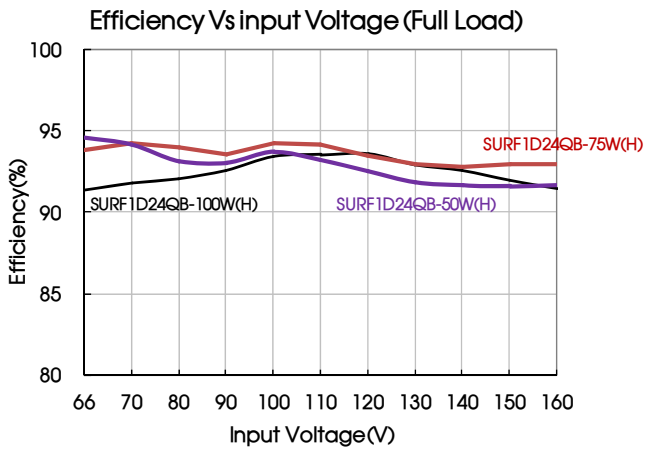

Thermal Curves

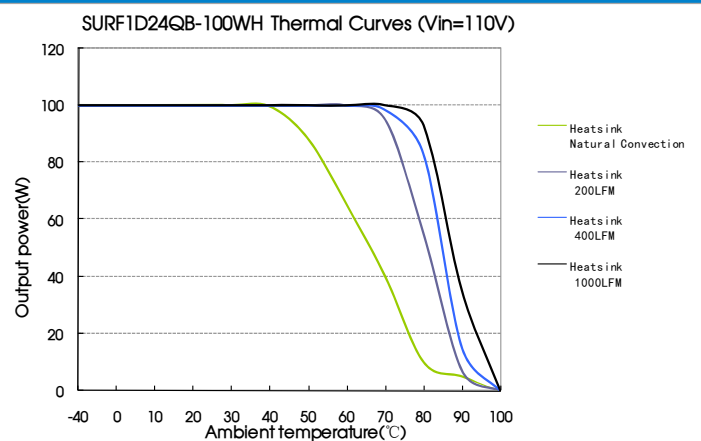
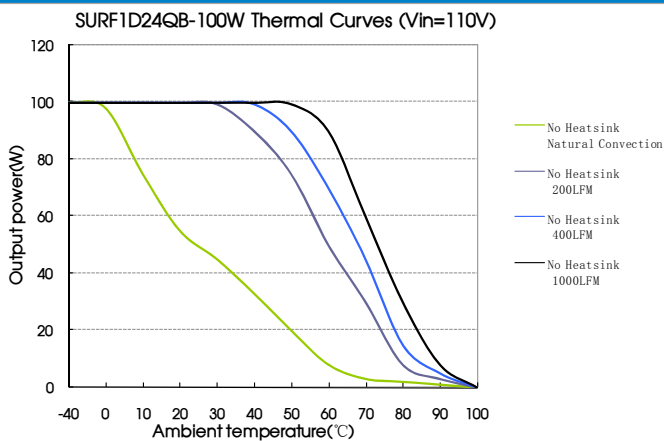

DC/DC Converter

SURF1D_QB Series

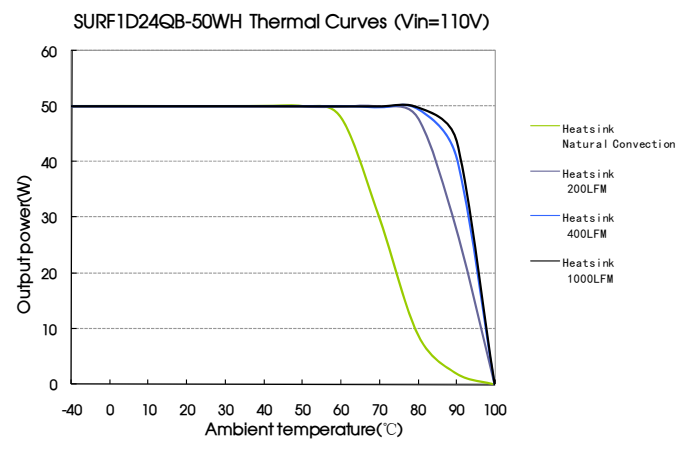
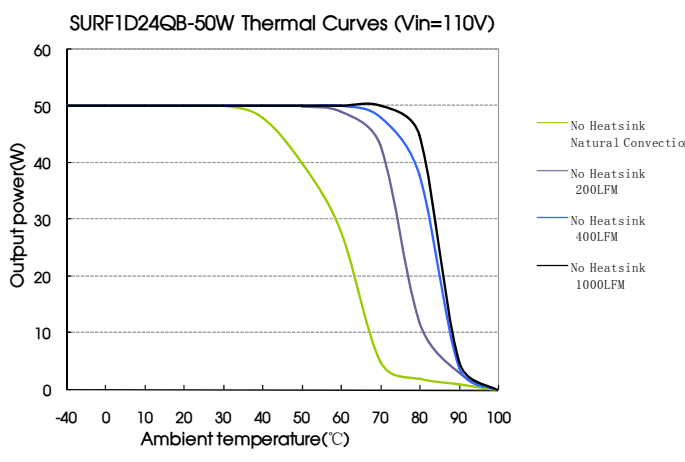
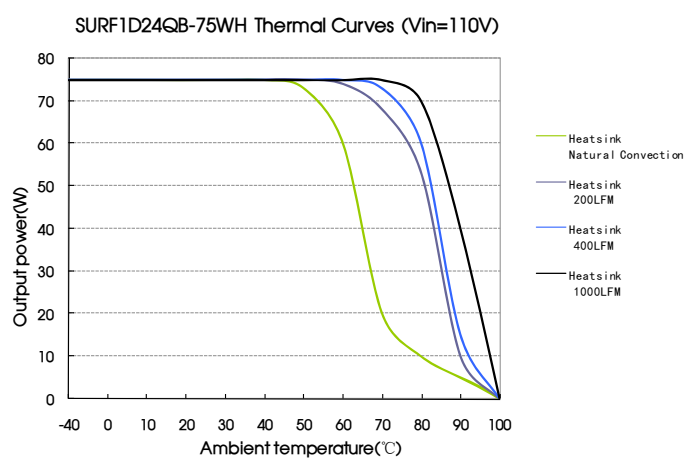
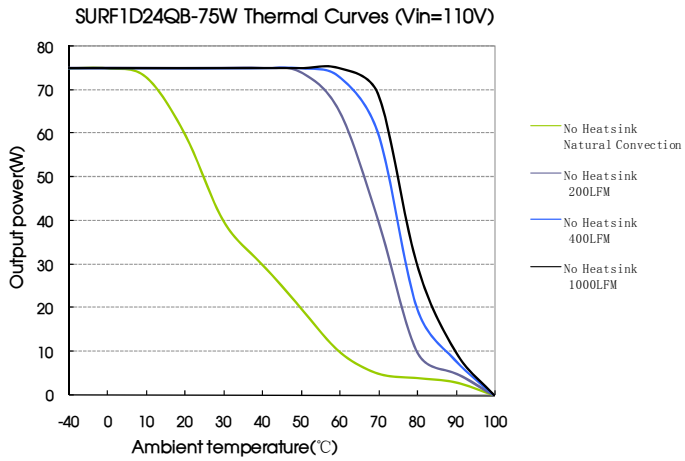

Sense of application and precautions

1. When Remote Sense is not used

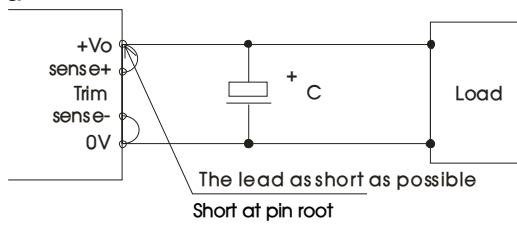

Notes:

- 1) When remote sense is not used, make sure +Vo and Sense + are shorted, and that 0V and Sense- are shorted as well;
- 2) Keep the patterns between +Vo and Sense + and 0V and Sense- as short as possible. Avoid a looping pattern. If noise enters the loop, the operation of the power module will become unstable.

2. When Remote Sense is used

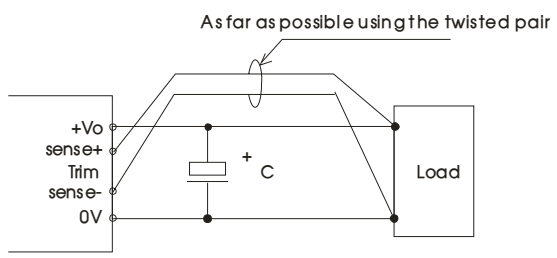

Notes:

1. Using remote sense with long wires may cause output voltage to become unstable. Consult us if long sensing wiring is necessary.
2. Sense patterns or wires should be as short as possible. If wires are used, use either twisted-pair or shielded wires.
3. Please Use wide PCB trace or a thick wires between the power supply module and the load, the line voltage drop should be kept less than 0.3V. Make sure the power supply module's output voltage remains within the specified range.
4. The impedance of wires may cause the output the voltage oscillation or have a greater ripple, please do adequate assessments before using.

DC/DC Converter

SURF1D_QB Series

Design Reference

1. Ripple & noise

All the SURF1D_QB-100W series have been tested according to the following recommended test circuit before leaving the factory (see Fig 1).

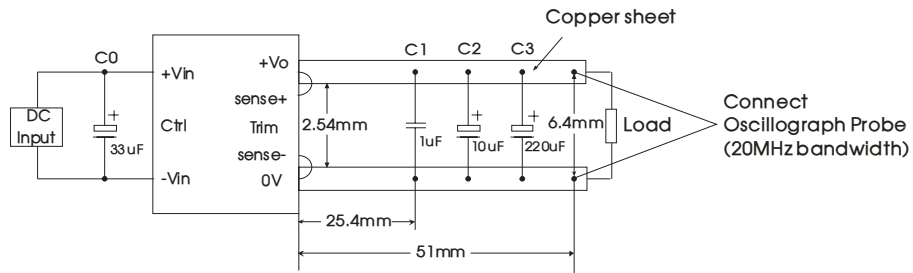

Fig. 1

2. Typical application

If don't use our company's EMC models, please make sure the input of at least 33uF electrolytic capacitor in parallel to suppress the input terminal may produce surge voltage.

If it is required to further reduce input and output ripple, properly increase the input & output of additional capacitors Cin and Cout or select capacitors of low equivalent impedance provided that the capacitance is no larger than the max. capacitive load of the product.



Capacitive Parameter	Cout(μF)	Cin(μF)
Output Voltage		
24V	220	100

3. EMC solution-module recommended circuit

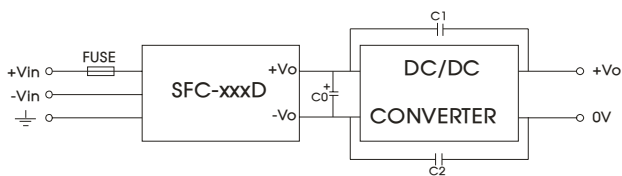
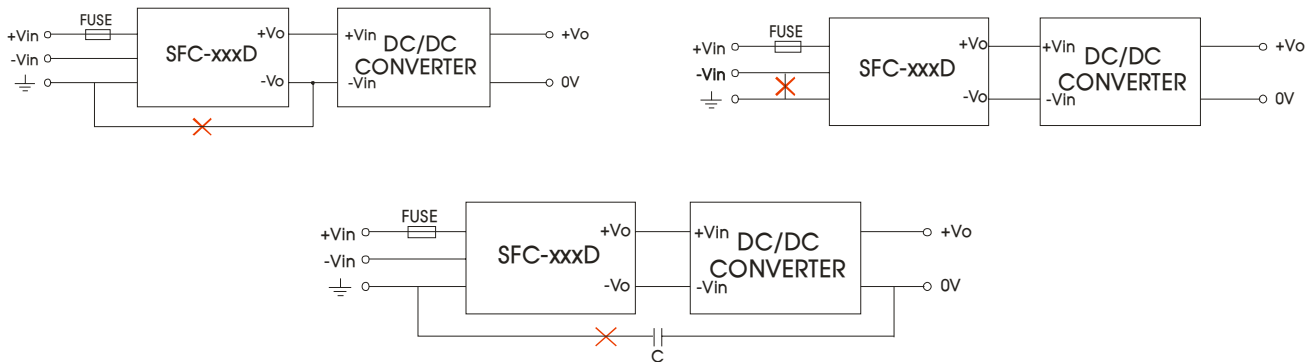

Fig. 2

C0	82uF/200V electrolytic capacitor
C1, C2	2200pF/400VAC capacitor
SFC-xxxD	recommended to use SCHMID-M's SFC-CX3D
FUSE	Due to the difference of the power module input current, the fuse of the recommended values, please refer to the Technical Manual for the power module.

4. These applications are not supported for the follow models



DC/DC Converter

SURF1D_QB Series

5. Thermal design

The maximum operating temperature of base-plate TB is 100 °C, as long as the user's thermal system keeps TB <100 °C, the converter can deliver its full rated power. A power derating curve can be calculated for any heatsink that is attached to the base-plate of the converter. It is only necessary to determine the thermal resistance, Rth(B-A), of the chosen heatsink between the base-plate and the ambient air for a given airflow rate. This information is usually available from the heatsink vendor. The following formula can be used to determine the maximum power the converter can dissipate for a given thermal condition if its base-plate is to be no higher than 100 °C.

$$P_{diss}^{max} = \frac{100^{\circ}C - T_A}{R_{th(B-A)}} \quad (T_A \text{ is ambient temperature})$$

The maximum load operating power of power supply module at a certain ambient temperature can be calculated by the power dissipation, Formula is as follows:

$$P_{O\ max} = \frac{P_{diss}^{max}}{\left(\frac{1}{\eta} - 1\right)} \quad (\eta \text{ is converter efficiency})$$

Therefore, customers can according to the actual application to choose the right heatsink.

6. Application of Trim and calculation of Trim resistance

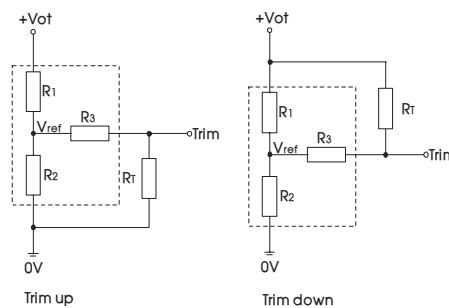

Applied circuits of Trim (Part in broken line is the interior of models)

Calculation formula of Trim resistance:

$$\text{up: } R_{T1} = \frac{\alpha R_2}{R_2 - \alpha} - R_3 \quad \alpha = \frac{V_{ref}}{V_o' - V_{ref}} \cdot R_1$$

$$\text{down: } R_{T1} = \frac{\alpha R_1}{R_1 - \alpha} - R_3 \quad \alpha = \frac{V_o' - V_{ref}}{V_{ref}} \cdot R_2$$

Note: Value for R1, R2, R3, and Vref refer to the above table 1. Rtr: Resistance of Trim. α: User-defined parameter, no actual meanings. Vo': The trim up/down voltage.

table 1

Vo	24(VDC)
Parameter	
R1(KΩ)	24.87
R2(KΩ)	2.87
R3(KΩ)	20
Vref(V)	2.5

7. The product does not support in parallel and hot-plug use

DC/DC Converter

SURF1D_QB Series

Dimensions and Recommended Layout (without heatsink)

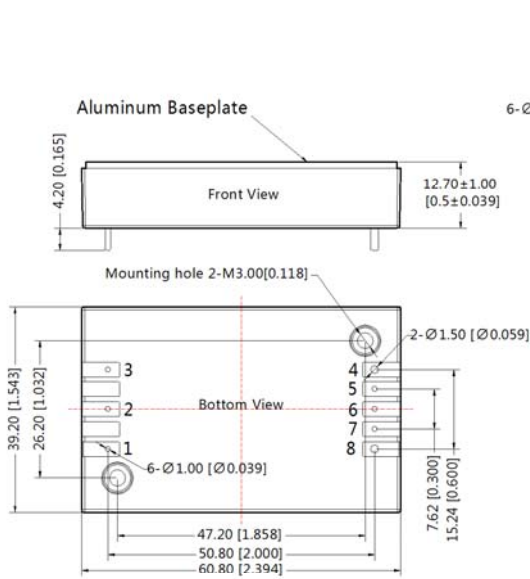

Note:
 Unit:mm[inch]
 Pin1,2,3,5,6,7's diameter:1.00[0.039]
 Pin4,8's diameter:1.50[0.059]
 Pin diameter tolerances:±0.10[±0.004]
 General tolerances:±0.50[±0.020]
 Mounting hole screwing torque: Max 0.4 N·m

THIRD ANGLE PROJECTION

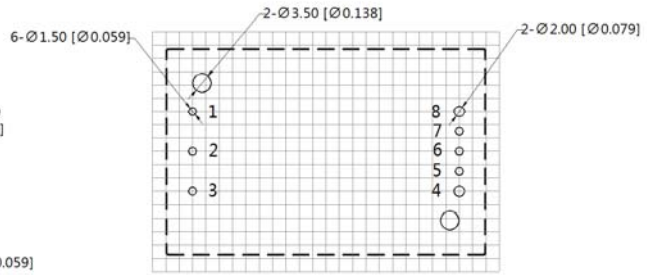

Note:Grid 2.54*2.54mm

Pin-Out			
Pin	Function	Pin	Function
1	+Vin	5	Sense-
2	Ctrl	6	Trim
3	-Vin	7	Sense+
4	0V	8	+Vo

Dimensions and Recommended Layout(with heatsink)

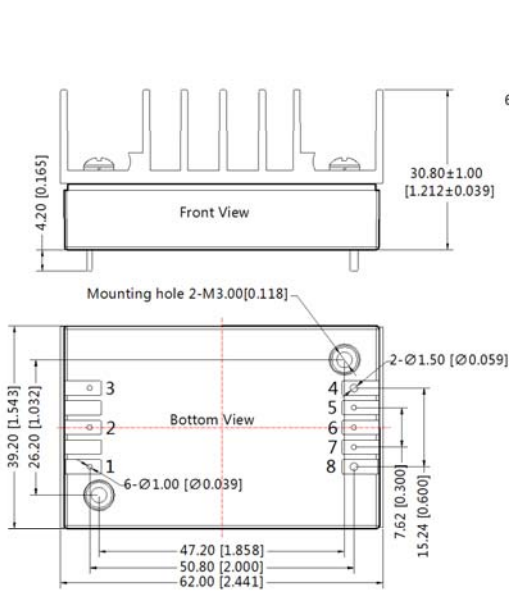

Note:
 Unit:mm[inch]
 Pin1,2,3,5,6,7's diameter:1.00[0.039]
 Pin4,8's diameter:1.50[0.059]
 Pin diameter tolerances:±0.10[±0.004]
 General tolerances:±0.50[±0.020]
 Mounting hole screwing torque: Max 0.4 N·m

THIRD ANGLE PROJECTION

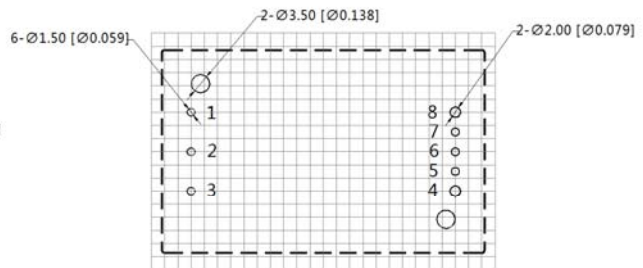

Note:Grid 2.54*2.54mm

Pin-Out			
Pin	Function	Pin	Function
1	+Vin	5	Sense-
2	Ctrl	6	Trim
3	-Vin	7	Sense+
4	0V	8	+Vo

DC/DC Converter

SURF1D_QB Series

Note

1. Packing Information please refer to 'Product Packing Information'. Packing bag number:58010113(without heatsink), 58010112(with heatsink);
2. Recommended used in more than 5% load, if the load is lower than 5%, then the ripple index of the product may exceed the specification, but does not affect the reliability of the product;
3. The max capacitive load should be tested within the input voltage range and under full load conditions;
4. If the customer tests EMC, suggest to take our EMC module FC-CX3D. If the customer needs to meet the performance aspects of the surge, and don't take our EMC module FC-CX3D, please make sure the surge residual voltage less than 180V, to ensure the reliability of the product;
5. Recommends that customers plus silicone film or thermal grease between the module and the heatsink. In order to ensure good heat dissipation;
6. Unless otherwise specified, data in this datasheet should be tested under the conditions of $T_a=25^{\circ}\text{C}$, humidity<75% when inputting nominal voltage and outputting rated load;
7. All index testing methods in this datasheet are based on our Company's corporate standards;
8. The performance indexes of the product models listed in this datasheet are as above, but some indexes of non-standard model products will exceed the above-mentioned requirements, and please directly contact our technicians for specific information;
9. We can provide product customization service;
10. Specifications of this product are subject to changes without prior notice.