

DC/DC Converter

SURB1D_LMD-15WR3 & SURB1D_LMD-20WR3 Series



15&20W, Ultra wide input isolated & regulated DC/DC converter



FEATURES

- Ultra wide input voltage range (4:1)
- Enhanced isolation, isolation voltage: 2250VDC
- Operating temperature range: -40°C to +85°C
- Input under-voltage protection, Output short circuit, over-current, over-voltage protection
- Low ripple & noise
- EMI meet EN50121-3-2, without external components
- Meets requirements of railway standard EN50155
- IEC60950, UL60950, EN60950 approval
- Reverse voltage protection available with A2S(Chassis mounting) or A4S(35mm DIN-Rail mounting)
- International standard pin-out

SURB1D_LMD-15WR3 series are isolated 15W DC-DC products with 4:1 input voltage. **SURB1D_LMD-20WR3 series** are isolated 20W DC-DC products with 4:1 input voltage. Their feature efficiency up to 86%, 2250VDC isolation with Enhanced Isolation, operating temperature of -40°C to +85°C, Input Under-voltage Protection, Output short circuit, over-current, over-voltage protection. Railway vehicle electronic equipment widely used in 72V, 96V and 110V.

Selection Guide

Certification	Part No. ①	Input Voltage (VDC)		Output		Efficiency ^③ (%Min./Typ.) @ Full Load	Max. Capacitive Load(μF)
		Nominal (Range)	Max. ②	Output Voltage (VDC)	Output Current (mA)(Max./Min.)		
UL/CE/CB	SURB1D03LMD-15WR3	110 (40-160)	170	3.3	4000/0	80/82	5400
	SURB1D05LMD-15WR3			5	3000/0	82/84	5400
	SURB1D12LMD-15WR3			12	1250/0	82/84	1000
	SURB1D15LMD-15WR3			15	1000/0	83/85	820
	SURB1D24LMD-15WR3			24	625/0	83/85	270
	SURB1D03LMD-20WR3			3.3	5000/0	80/82	10000
	SURB1D05LMD-20WR3			5	4000/0	82/84	10000
	SURB1D12LMD-20WR3			12	1667/0	83/85	1600
	SURB1D15LMD-20WR3			15	1333/0	84/86	1000
	SURB1D24LMD-20WR3			24	833/0	84/86	470

Note:
 ① Series with suffix "H" are heat sink mounting; series with suffix "A2S" are chassis mounting, with suffix "A4S" are DIN-Rail mounting, for example SURB1D05LMD-20WR3A2S is chassis mounting of with heat sink, SURB1D05LMD-20WR3A4S is DIN-Rail mounting of without heat sink; If the application has a higher requirement for heat dissipation, you can choose modules with heat sink;
 ② Absolute maximum rating without damage on the converter, but it isn't recommended;
 ③ Efficiency is measured in nominal input voltage and rated output load; A2S (wiring) and A4S (rail) Model due to input reverse polarity protection, minimum efficiency greater than Min.-2 is qualified.

Input Specifications

Item	Operating Conditions	Min.	Typ.	Max.	Unit	
Input Current (full load / no-load)	SURB1D_LMD-15WR3 series, Nominal input voltage	3.3V output	--	147/10	150/20	mA
		5V output	--	163/10	167/20	
		Others	--	159/3	166/8	
	SURB1D_LMD-20WR3 series, Nominal input voltage	3.3V output	--	183/10	188/20	
		5V output	--	217/10	222/20	
		Others	--	214/3	219/8	
Reflected Ripple Current	Nominal input voltage	--	25	--		

DC/DC Converter

SURB1D_LMD-15WR3 & SURB1D_LMD-20WR3 Series

Surge Voltage (1sec. max.)		-0.7	--	180	VDC
Starting Voltage	100% load	--	--	40	
Shutdown Voltage		28	33	--	
Starting Time	Nominal input voltage & constant resistance load	--	10	--	ms
Input Filter		Pi filter			
Hot Plug		Unavailable			
Ctrl*	Module switch on	Ctrl suspended or connected to TTL high level (3.5-12VDC)			
	Module switch off	Ctrl pin connected to GND or low level (0-1.2VDC)			
	Input current when switched off	--	2	7	mA

Note: * the voltage of Ctrl pin is relative to input pin GND.

Output Specifications

Item	Operating Conditions	Min.	Typ.	Max.	Unit	
Output Voltage Accuracy	0%-100% load	--	±1	±3	%	
Line Regulation	Full load, the input voltage is from low voltage to high voltage	--	±0.2	±0.5		
Load Regulation	0%-100% load	--	±0.5	±1		
Transient Recovery Time		--	300	500	μs	
Transient Response Deviation	25% load step change, nominal input voltage	3.3V/5V output	--	±3	±8	%
		Others	--	±3	±5	
Temperature Coefficient	Full load	--	±0.02	±0.03	%/°C	
Ripple & Noise *	20MHz bandwidth, 5%-100% load	--	50	100	mV p-p	
Trim		90	--	110	%Vo	
Output Over-voltage Protection		110	--	160		
Output Over-current Protection	Input voltage range	120	--	210	%Io	
Short Circuit Protection		Continuous, self-recovery				

Note: *0%-5% load ripple&Noise is no more than 5%Vo.Ripple and noise are measured by "parallel cable" method, please see DC-DC Converter Application Notes for specific operation.

General Specifications

Item	Operating Conditions	Min.	Typ.	Max.	Unit
Insulation Voltage	Input-output, with the test time of 1 minute and the leak current lower than 1mA.	2250	--	--	VDC
	Input and output respectively on the shell, with the test time of 1 minute and the leak current lower than 1mA.	1600	--	--	
Insulation Resistance	Input-output, isolation voltage 500VDC	1000	--	--	MΩ
Isolation Capacitance	Input-output, 100KHz/0.1V	--	2200	--	pF
Operating Temperature	see Fig. 1	-40	--	+85	°C
Storage Temperature		-55	--	+125	
Storage Humidity	Non-condensing	5	--	95	%RH
Pin Welding Resistance Temperature	Welding spot is 1.5mm away from the casing, 10 seconds	--	--	+300	°C
Switching Frequency*	PWM mode	--	300	--	KHz
Shock & Vibration test		IEC 61373, car body 1 B mold			
MTBF	MIL-HDBK-217F@25°C	1000	--	--	K hours

Note: *This series of products using reduced frequency technology, the switching frequency is test value of full load,When the load is reduced to below 50%, the switching frequency decreases with decreasing load.

DC/DC Converter

SURB1D_LMD-15WR3 & SURB1D_LMD-20WR3 Series

Physical Specifications

Casing Material		Aluminum alloy	
Package Dimensions	Without heat sink	Horizontal package	50.80*25.40*11.80mm
		A2S wiring package	76.00*31.50*21.20 mm
		A4S rail package	76.00*31.50*25.80 mm
Package Dimensions	With heat sink	Horizontal package	51.40*26.20*16.50mm
		A2S wiring package	76.00*31.50*25.30 mm
		A4S rail package	76.00*31.50*29.90 mm
Weight	Without heat sink	Horizontal package/A2S wiring package/A4S rail package	26g/48g/68g(Typ.)
	With heat sink	Horizontal package/A2S wiring package/A4S rail package	34g/56g/76g(Typ.)
Cooling Method		Free air convection	

EMC Specifications

EMI	CE	CISPR32/EN55032	CLASS A(see Fig.3 for recommended circuit)/ CLASS B(see Fig.5-② for recommended circuit)	
	RE	CISPR32/EN55032	CLASS A(without external components)/ CLASS B (see Fig.5-② for recommended circuit)	
EMS	ESD	IEC/EN61000-4-2	Contact ± 6 KV/Air ± 8 KV	perf. Criteria B
	RS	IEC/EN61000-4-3	10V/m	perf. Criteria A
	EFT	IEC/EN61000-4-4	± 4 KV (see Fig.4 or Fig.5-① for recommended circuit)	perf. Criteria B
	Surge	IEC/EN61000-4-5	line to line ± 2 KV (2Ω 18uF see Fig.4 for recommended circuit)	perf. Criteria B
			line to ground ± 4 KV (12Ω 9uF see Fig.4 for recommended circuit)	perf. Criteria B
Surge	EN50121-3-2	line to line ± 1 KV (42Ω 0.5uF see Fig.5-① for recommended circuit)	perf. Criteria B	
		line to ground ± 2 KV (42Ω 0.5uF see Fig.5-① for recommended circuit)	perf. Criteria B	
CS	IEC/EN61000-4-6	10 Vr.m.s	perf. Criteria A	

Product Characteristic Curve

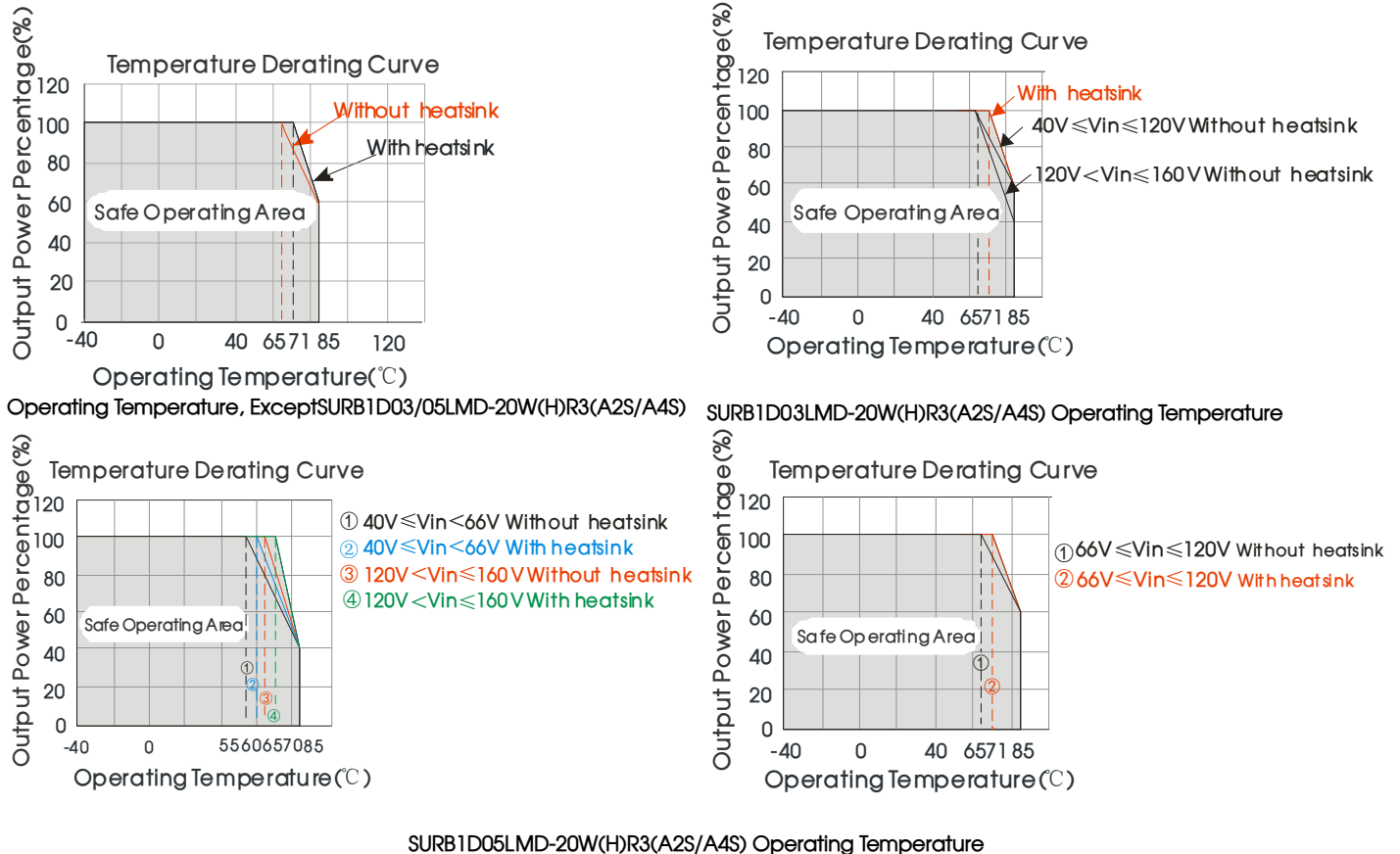
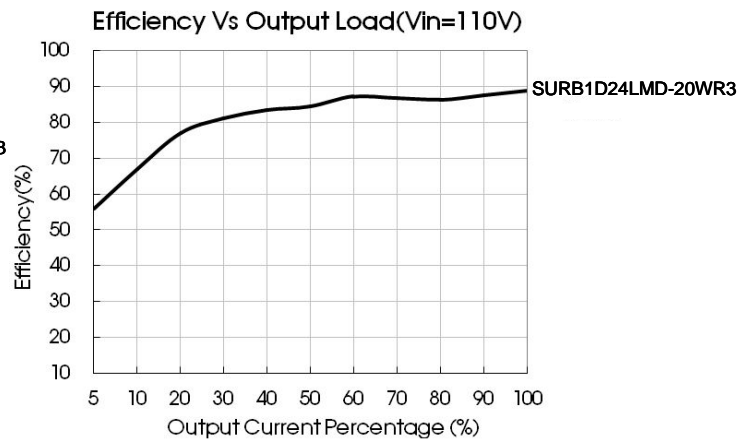
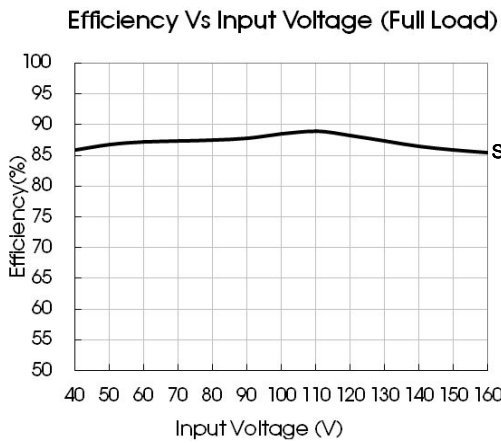
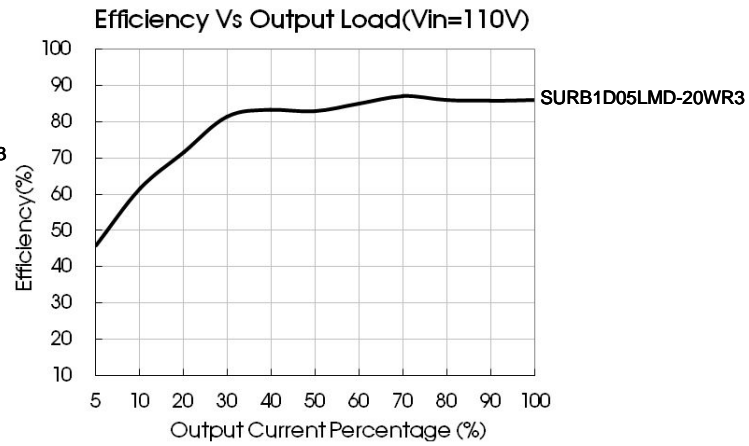
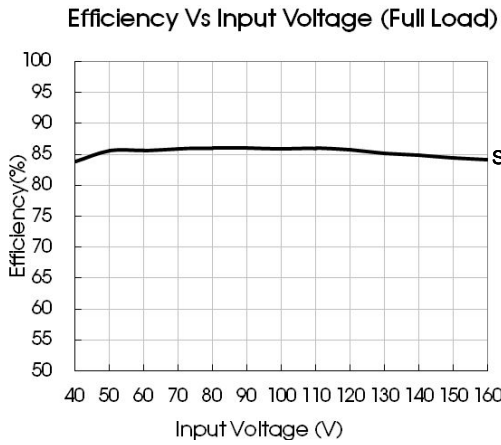

Fig. 1

DC/DC Converter

SURB1D_LMD-15WR3 & SURB1D_LMD-20WR3 Series



Design Reference

1. Typical application

All the DC/DC converters of this series are tested according to the recommended circuit (see Fig. 2) before delivery.

If it is required to further reduce input and output ripple, properly increase the input & output of additional capacitors C_{in} and C_{out} or select capacitors of low equivalent impedance provided that the capacitance is no larger than the max. capacitive load of the product.

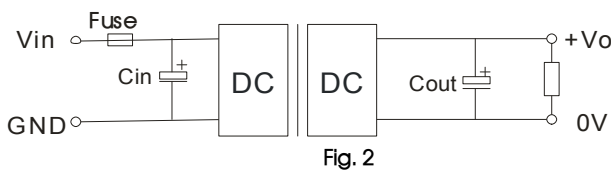

$V_{out}(VDC)$	Fuse	C_{in}	C_{out}
3.3/5	2A, slow blow	10 μ F - 47 μ F	470 μ F
12/15			220 μ F
24			100 μ F

2. EMC solution-recommended circuit

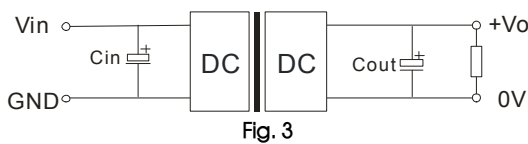
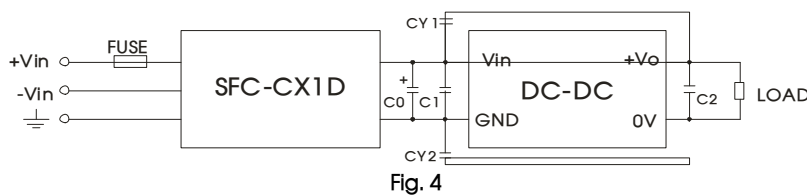

Fig. 3 Parameter description:

C_{in}	27 μ F - 100 μ F/250V
C_{out}	Refer to the C_{out} in Fig.2

Notes: Fig. 3 C_{in} please use the 250V withstand voltage of the capacitor.



DC/DC Converter

SURB1D_LMD-15WR3 & SURB1D_LMD-20WR3 Series

Fig. 4 Parameter description:

FUSE	Choose according to actual input current
SFC-CX1D	SFC-CX1D is the EMC auxiliary component of our company. Input voltage range: 40V-160V
C0	100μF/200V
C1	Refer to the Cin in Fig.2
C2	Refer to the Cout in Fig.2
CY1、CY2	1000pF/400VAC

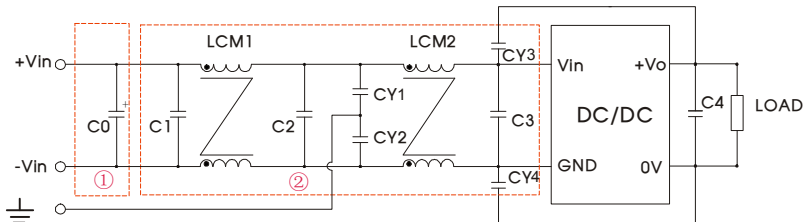

Fig. 5

Notes: Part ① in the Fig. 5 is used for EMS test and part ② for EMI filtering; selected based on needs.

Fig. 5 Parameter description:

Model	SURB1D_LMD-15WR3	SURB1D_LMD-20WR3
C0	100μF/200V	
C1、C2	0.22μF/250V	
C3	Refer to the Cin in Fig.2	
LCM1	15mH (UU common mode inductance)	2.2mH(SFL2D-10-222)
LCM2	15mH (UU common mode inductance)	0.53mH (material: TN150P-RH12.7*12.7*7.9)
CY1、CY2、CY3、CY4	1000pF/400VAC	
C4	Refer to the Cout in Fig.2	

Notes: SFL2D-10-222 for SCHMID-M's EMC auxiliary device

3. Trim application & Trim resistance

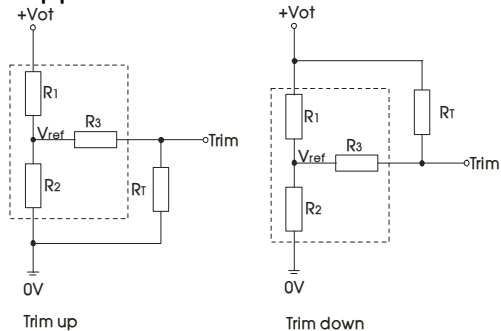

Calculation formula of Trim resistance:

$$\begin{aligned} \text{up: } R_T &= \frac{\alpha R_2}{R_2 - \alpha} - R_3 & \alpha &= \frac{V_{ref}}{V_o' - V_{ref}} \cdot R_1 \\ \text{down: } R_T &= \frac{\alpha R_1}{R_1 - \alpha} - R_3 & \alpha &= \frac{V_o' - V_{ref}}{V_{ref}} \cdot R_2 \end{aligned}$$

Application circuit for TRIM (Part in broken line is the interior of models)

Note: Leave open if not used. R_T : Resistance of Trim. α : User-defined parameter, no actual meanings.

Vout(V)	R1(KΩ)	R2(KΩ)	R3(KΩ)	Vref(V)
3.3	4.801	2.87	10	1.24
5	2.883	2.87	10	2.5
12	11.000	2.87	15	2.5
15	14.384	2.87	15	2.5
24	24.872	2.87	17.8	2.5

4. It is not allowed to connect modules output in parallel to enlarge the power

DC/DC Converter

SURB1D_LMD-15WR3 & SURB1D_LMD-20WR3 Series

Horizontal Package (without heat sink) Dimensions and Recommended Layout

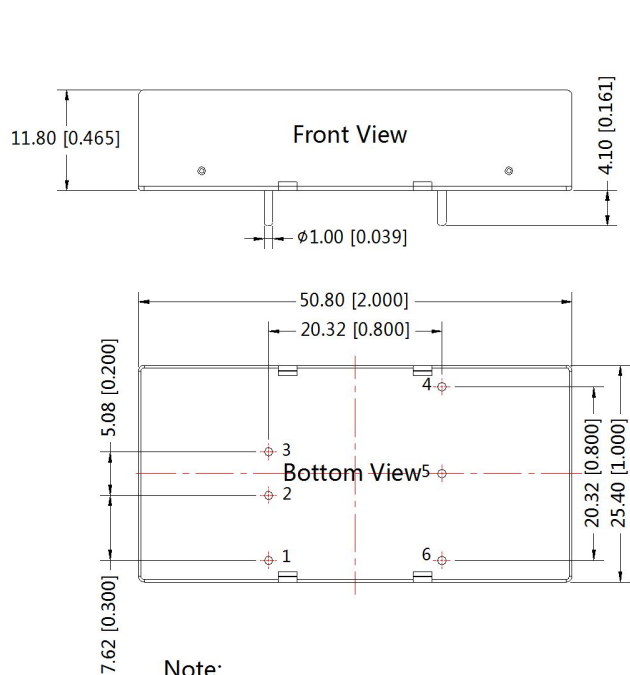

Note:
 Unit: mm[inch]
 Pin diameter tolerances: $\pm 0.10[\pm 0.004]$
 General tolerances: $\pm 0.50[\pm 0.020]$

THIRD ANGLE PROJECTION

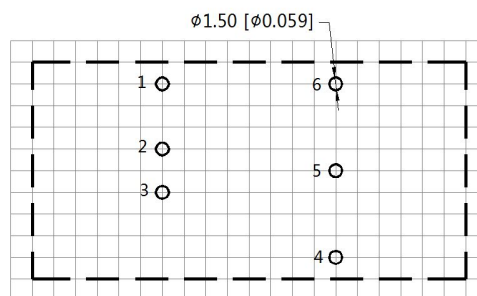

Note : Grid 2.54*2.54mm

Pin-Out	
Pin	Function
1	Ctrl
2	GND
3	Vin
4	+Vo
5	Trim
6	0V

Horizontal Package (with heatsink) Dimensions

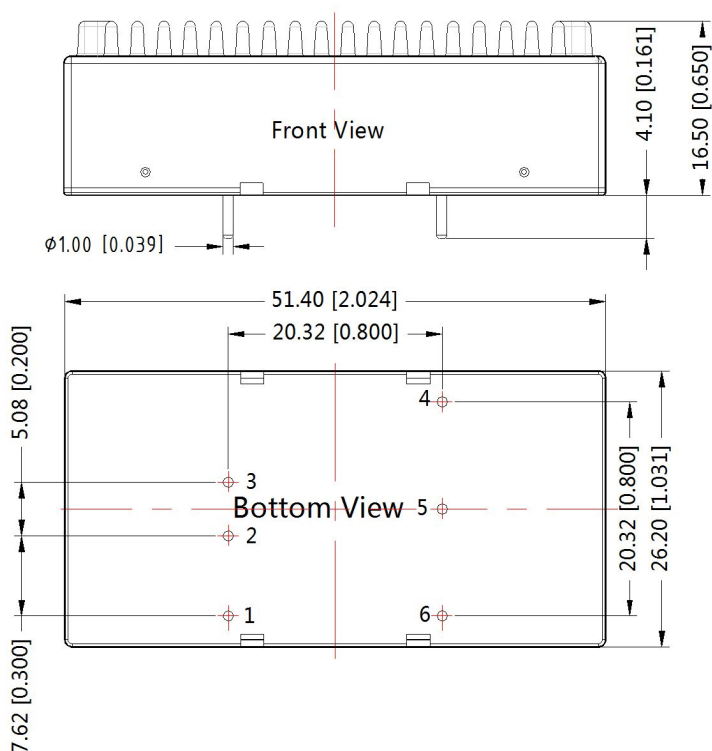

Note:
 Unit :mm[inch]
 General tolerances: $\pm 0.50[\pm 0.020]$

THIRD ANGLE PROJECTION

Pin-Out	
Pin	Function
1	Ctrl
2	GND
3	Vin
4	+Vo
5	Trim
6	0V

DC/DC Converter

SURB1D_LMD-15WR3 & SURB1D_LMD-20WR3 Series

SURB1D_LMD-15WR3A2S & SURB1D_LMD-20WR3A2S (without heatsink) Dimensions

THIRD ANGLE PROJECTION 

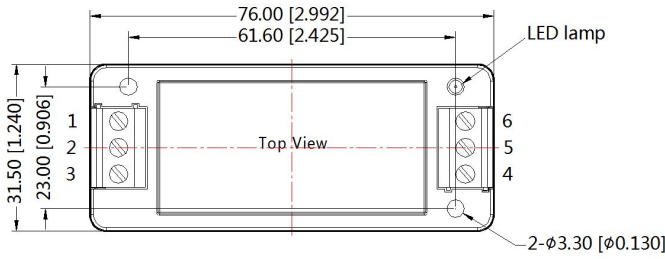

Pin-Out						
Pin	1	2	3	4	5	6
Function	Ctrl	GND	Vin	+Vo	Trim	0V

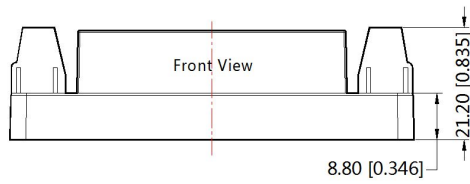

Note:
 Unit: mm[inch]
 Wire range: 24-12 AWG
 Tightening torque: Max 0.4 N·m
 General tolerances: $\pm 0.50[\pm 0.020]$

SURB1D_LMD-15WHR3A2S & SURB1D_LMD-20WHR3A2S (with heatsink) Dimensions

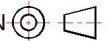
THIRD ANGLE PROJECTION 

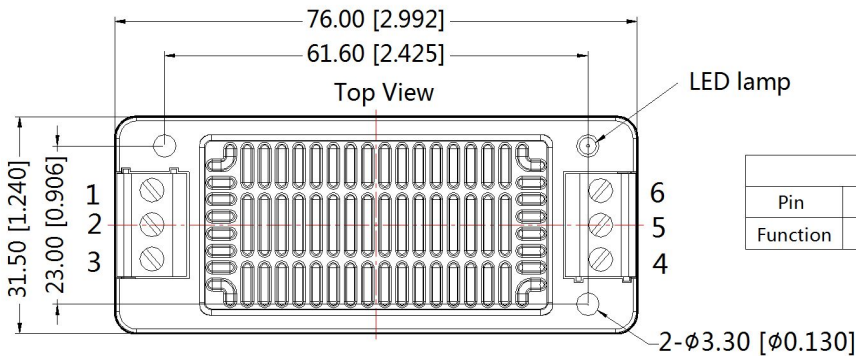

Pin-Out						
Pin	1	2	3	4	5	6
Function	Ctrl	GND	Vin	+Vo	Trim	0V

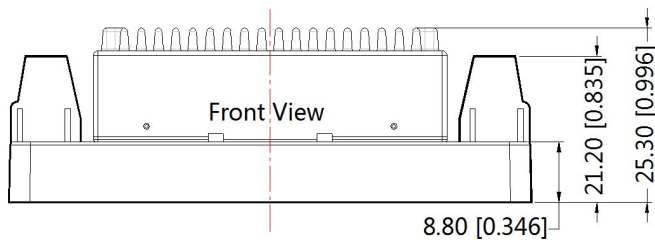

Note:
 Unit: mm[inch]
 Wire range: 24-12 AWG
 Tightening torque: Max 0.4 N·m
 General tolerances: $\pm 1.00[\pm 0.039]$

DC/DC Converter

SURB1D_LMD-15WR3 & SURB1D_LMD-20WR3 Series

SURB1D_LMD-15WR3A4S & SURB1D_LMD-20WR3A4S (without heatsink) Dimensions

THIRD ANGLE PROJECTION 

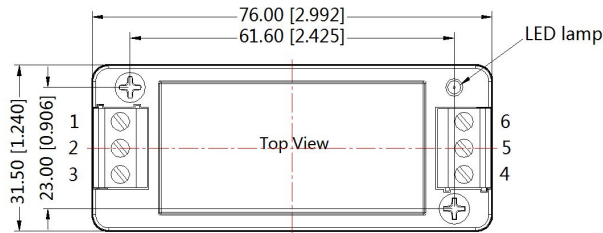

Pin-Out						
Pin	1	2	3	4	5	6
Function	Ctrl	GND	Vin	+Vo	Trim	0V

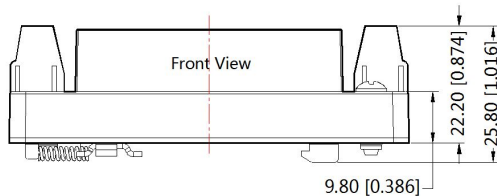

Note:
 Unit: mm[inch]
 Mounting rail: TS35
 Wire range: 24-12 AWG
 Tightening torque: Max 0.4 N·m
 General tolerances: $\pm 1.00[\pm 0.039]$

SURB1D_LMD-15WHR3A4S & SURB1D_LMD-20WHR3A4S (with heatsink) Dimensions

THIRD ANGLE PROJECTION 

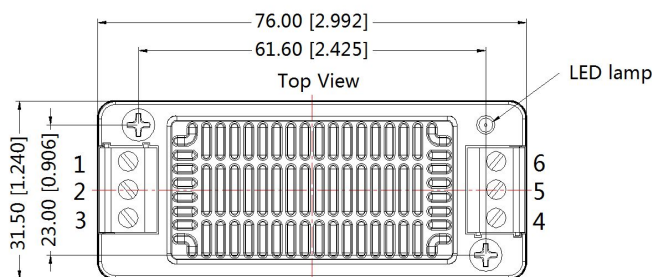

Pin-Out						
Pin	1	2	3	4	5	6
Function	Ctrl	GND	Vin	+Vo	Trim	0V

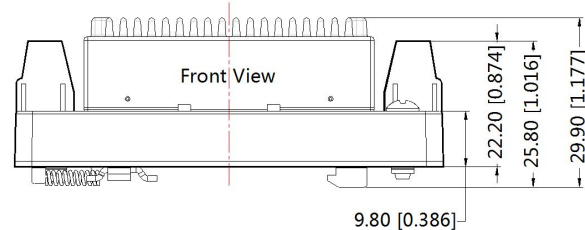

Note:
 Unit: mm[inch]
 Mounting rail: TS35
 Wire range: 24-12 AWG
 Tightening torque: Max 0.4 N·m
 General tolerances: $\pm 1.00[\pm 0.039]$

Note:

1. The maximum capacitive load offered were tested at input voltage range and full load;
2. Unless otherwise specified, parameters in this datasheet were measured under the conditions of $T_a=25^\circ\text{C}$, humidity<75%RH with nominal input voltage and rated output load;
3. All index testing methods in this datasheet are based on Company's corporate standards;
4. Other product application information, please see DC-DC (railway power supply) Converter Application Notes for specific operation methods;
5. We can provide product customization service, please contact our technicians directly for specific information;
6. Specifications are subject to change without prior notice.