

SCHMID-M

SVRA_D-5W & SVRB_D-5W Series

5W, 2:1 WIDE INPUT, ISOLATED & REGULATED
DUAL/SINGLE OUTPUT DC-DC CONVERTER

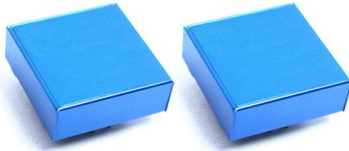

PART NUMBER SYSTEM

SVRA 2405D-5W

Rated Power
Package Style
Output Voltage
Input Voltage
Product Series



FEATURES

- Efficiency up to 85%
- 1.5KVDC Isolation
- Operating temperature: -40°C ~ +85°C
- Metal shielding package
- Industry standard pinout
- Good Performance Under Both High and Low Temperature, Meet Industrial Technical Requirements

APPLICATIONS

The SVRA_D-5W & SVRB_D-5W series are designed for application where isolated output is required from a distributed power system.

These products apply to where:

- 1) Input voltage range: $\leq 2:1$;
- 2) 1.5KV input and output isolation;
- 3) Regulated and low ripple noise is required.

SELECTION GUIDE

Model Number	Input Voltage(VDC)		Output Voltage (VDC)	Output Current (mA)		Input Current (mA)(typ.)		Reflected Ripple Current (mA,typ.)	Max. Capacitive Load [#] (μF)	Efficiency (% , typ.) @Max. Load			
	Nominal (Range)	Max*		Max.	Min.	@Max. Load	@No Load						
SVRA1205D-5W	12 (9-18)	20	±5	±500	±50	521	13	50	1430	77			
SVRA1209D-5W			±9	±278	±27	520	--		--	80			
SVRA1212D-5W			±12	±210	±21	504	15		200	82			
SVRA1215D-5W			±15	±166	±16	511	19		100	80			
SVRA1224D-5W			±24	±105	±10	526	32		47	84			
SVRB1205D-5W			5	1000	100	509	6		8570	78			
SVRB1209D-5W			9	556	55	494	15		470	80			
SVRB1212D-5W			12	420	42	500	17		288	82			
SVRB1215D-5W			15	330	33	247	17		241	82			
SVRB1224D-5W			24	200	20	471	23		68	83			
SVRA2405D-5W			24 (18-36)	40	±5	±500	±50		252	4	50	727	80
SVRA2409D-5W					±9	±278	±27		242	8		503	82
SVRA2412D-5W	±12	±210			±21	245	10	330	83				
SVRA2415D-5W	±15	±166			±16	246	9	247	83				
SVRA2424D-5W	±24	±105			±10	248	12	68	84				
SVRB2405D-5W	5	1000			100	258	6	2000	80				
SVRB2409D-5W	9	556			55	241	6	388	82				
SVRB2412D-5W	12	420			42	245	7	300	84				
SVRB2415D-5W	15	330			33	247	8	538	84				
SVRB2424D-5W	24	200			20	230	11	68	85				
SVRA4805D-5W	48 (36-75)	80			±5	±500	±50	125	--	150		--	82
SVRA4809D-5W					±9	±278	±27	127	--			--	81
SVRA4812D-5W			±12	±210	±21	121	5	160	85				
SVRA4815D-5W			±15	±166	±16	123	5	159	85				
SVRA4824D-5W			±24	±105	±10	120	--	--	86				
SVRB4805D-5W			5	1000	100	126	2	1780	82				
SVRB4809D-5W			9	556	55	127	--	--	84				
SVRB4812D-5W			12	420	42	126	10	617	85				
SVRB4815D-5W			15	330	33	122	--	--	85				
SVRB4824D-5W			24	200	20	124	--	--	86				

Note: 1. Models listed with strike-through text have been officially discontinued.
2. *Input voltage can't exceed this value, or will cause the permanent damage.
3. # For each output.

INPUT SPECIFICATIONS

Item	Test Conditions	Min.	Typ.	Max.	Unit
Input Surge Voltage (1000 ms)	12VDC Input Models	-0.7	--	25	VDC
	24VDC Input Models	-0.7	--	50	
	48VDC Input Models	-0.7	--	100	
Start-up Voltage	12VDC Input Models	--	--	9	
	24VDC Input Models	--	--	18	
	48VDC Input Models	--	--	36	
Under Voltage Shutdown	12VDC Input Models	--	--	9	
	24VDC Input Models	--	--	18	
	48VDC Input Models	--	--	36	
Start-up Time	Nominal input& constant resistance load	--	300	--	ms
Short Circuit Input Power		--	0.5	--	W
No-load power consumption		--	500	--	mW
Input Filter		L Filter			

OUTPUT SPECIFICATIONS

Item	Test Conditions	Min.	Typ.	Max.	Unit
Output Power		0.5	--	5	W
Positive voltage accuracy	Refer to recommended circuit	--	±1	±3	%
Negative voltage accuracy		--	±3	±5	
Output Voltage Balance	Dual Output, Balanced Loads	--	±0.5	±1	
Line Regulation	Full load, Input voltage from low to high	--	±0.2	±0.5	
Load Regulation	10% to 100% load	--	±0.5	±2	
Transient Recovery Time	25%~ 50%~25% load or	--	300	500	µs
Transient Response Deviation	50%~75%~50% load step change	--	±3	±5	%
Temperature Drift	100% full load	--	±0.02	--	%/°C
Ripple*	20MHz Bandwidth	--	30	50	mVp-p
Noise*		--	100	150	
Over Current Protection	Full input voltage	120	--	--	%
Short Circuit Protection		Continuous, automatic recovery			

Note: 1. Dual output models unbalanced load: ±5%.

2.*Test ripple and noise by "parallel cable" method. See detailed operation instructions at Testing of Power Converter section, application notes.

COMMON SPECIFICATIONS

Item	Test Conditions	Min.	Typ.	Max.	Unit
Isolation Voltage	Tested for 1 minute and leakage current less than 1 mA	1500	--	--	VDC
Isolation Resistance	Test at 500VDC	500	--	--	MΩ
Isolation Capacitance	Input/Output, 100KHz/0.1V	--	1000	--	pF
Switching Frequency	Full load, nominal input	--	300	--	KHz
MTBF	MIL-HDBK-217F@25°C	1000	--	--	K hours
Case Material		Aluminous alloy			
Weight		--	15	--	g

ENVIRONMENTAL SPECIFICATIONS

Item	Test Conditions	Min.	Typ.	Max.	Unit
Storage Humidity	Non condensing	5	--	95	%
Operating Temperature	Power derating (above 71°C)	-40	--	85	°C
Storage Temperature		-55	--	125	
Temp. rise allowed at full load	Operating Temperature curve range	--	75	--	
Lead Temperature	1.5mm from case for 10 seconds	--	--	300	
Cooling		Free air convection			

EMC SPECIFICATIONS

EMI	CE	CISPR22/EN55022 CLASS A (External Circuit Refer to Figure1-②)
EMS	ESD	IEC/EN61000-4-2 Contact ±4KV perf. Criteria B
	EFT	IEC/EN61000-4-4 ±2KV perf. Criteria B (External Circuit Refer to Figure 1-①)
	Surge	IEC/EN61000-4-5 ±2KV perf. Criteria B (External Circuit Refer to Figure 1-①)

EMC RECOMMENDED CIRCUIT

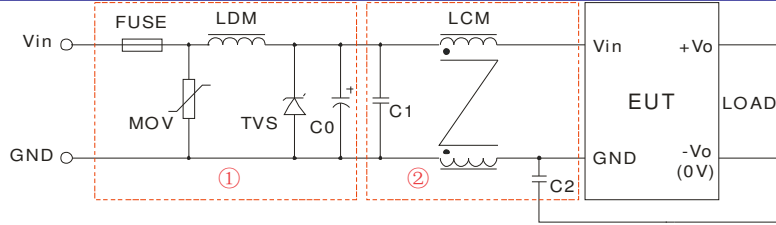

(Figure1)

SVRA_D-5W Recommended external circuit parameters:

Model		Vin: 12V	Vin: 24V	Vin: 48V
EMS	FUSE	Choose according to practical input current		
	MOV	--	10D560K	10D101K
	LDM	--	56μH	56μH
	TVS	SMCJ28A	SMCJ48A	SMCJ90A
	C0	680μF/25V	120μF/50V	120μF/100V
EMI	C1	4.7μF/50V	4.7μF/50V	4.7μF/100V
	LCM	9.5mH	9.5mH	9.5mH
	C2	100pF/2KV	100pF/2KV	100pF/2KV

SVRB_D-5W Recommended external circuit parameters:

Model		Vin: 12V	Vin: 24V	Vin: 48V
EMS	FUSE	Choose according to practical input current		
	MOV	--	10D560K	10D101K
	LDM	--	56μH	56μH
	TVS	SMCJ28A	SMCJ48A	SMCJ90A
	C0	680μF/25V	120μF/50V	120μF/100V
EMI	C1	--	4.7μF/50V	4.7μF/100V
	LCM	--	1.27mH	9.5mH
	C2	--	--	100pF/2KV

Note: 1. In Figure 1, part①is EMS Recommended external circuit, part②is EMI recommended external circuit. Choose according to requirements.
2. If there is no recommended parameters, the model no require the external component.

EMC RECOMMENDED CIRCUIT PCB LAYOUT

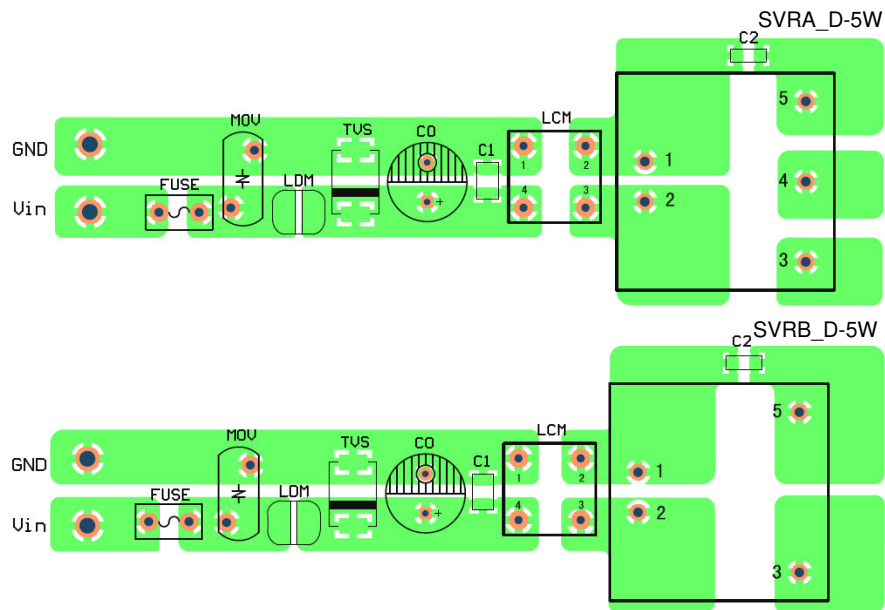

(Figure 2)

PRODUCT TYPICAL CURVE

Temperature Derating Curve

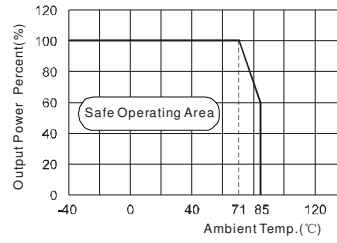

Efficiency VS Input Voltage curve (Full Load)

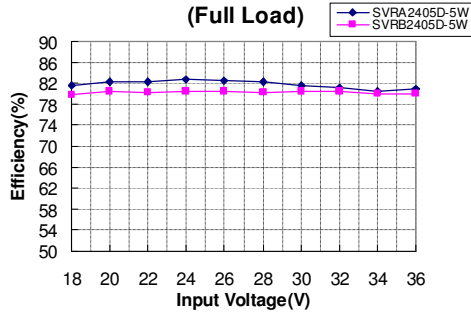

Efficiency VS Input Voltage curve (Full Load)

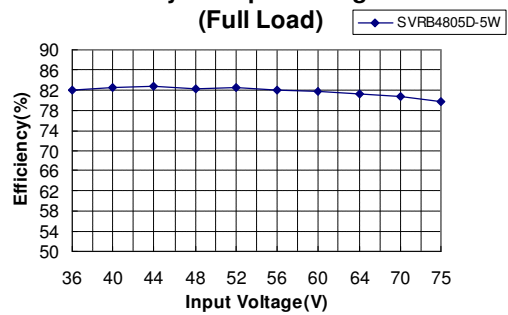

Efficiency VS Output Load curve (Vin=Vin-nominal)

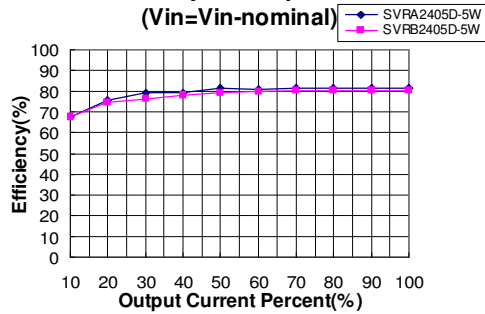

Efficiency VS Output Load curve (Vin=Vin-nominal)

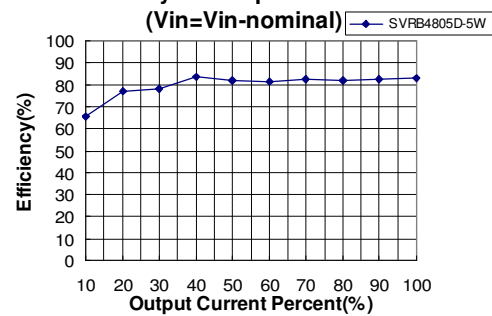

OUTLINE DIMENSIONS, RECOMMENDED FOOTPRINT & PACKAGING

MECHANICAL DIMENSIONS

Front View Dimensions:
 Total width: 27.50 [1.083]
 Pin 1 to Pin 5 width: 20.32 [0.800]
 Pin 1 to Pin 2 width: 4.10 [0.161]
 Pin 2 to Pin 3 width: 10.20 [0.402]
 Pin 3 to Pin 4 width: 0.50 [0.020]

Bottom View Dimensions:
 Total width: 27.50 [1.083]
 Pin 1 to Pin 5 width: 20.32 [0.800]
 Pin 1 to Pin 2 width: 5.08 [0.200]

FOOTPRINT DETAILS			
Pin	Single	Dual	
1	GND	GND	
2	Vin	Vin	
3	+Vo	+Vo	
4	No Pin	0V	
5	0V	-Vo	

Note:
 Unit: mm[inch]
 Pin diameter tolerances: ± 0.10mm [± 0.004inch]
 General tolerances: ± 0.50mm [± 0.020inch]

RECOMMENDED FOOTPRINT

DUAL

SINGLE

Note: grid 2.54*2.54mm.

TUBE OUTLINE DIMENSIONS

Note:
 Unit: mm[inch]
 General tolerances: ± 0.50mm [± 0.020inch]
 L=530mm [20.866inch] Tube Quantity: 19pcs
 L=220mm [8.661inch] Tube Quantity: 7pcs
 Short tube inner package dimensions: L*W*H= 255*170*80mm
 Short tube outer package dimensions(with six inner package boxes):
 L*W*H= 375*280*270mm
 Long tube inner package dimensions: L*W*H= 580*200*100mm
 Long tube outer package dimensions(with two inner package boxes):
 L*W*H= 600*215*220mm
 Long tube outer package dimensions(with three inner package boxes):
 L*W*H= 600*215*325mm

TEST CONFIGURATIONS

Input Reflected-Ripple Current Test Setup

Input reflected-ripple current is measured with an inductor L_{in} and C_{in} to simulate source impedance.

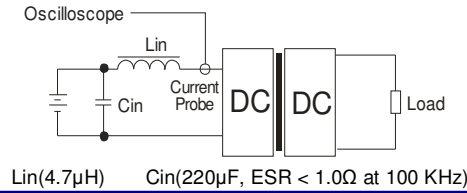

DESIGN CONSIDERATIONS

1) Requirement on output load

To ensure this module can operate efficiently and reliably, During operation, the minimum output load **could not be less than 10% of the full load**. If the actual output power is very small, please connect a resistor with proper resistance at the output end in parallel to increase the load, or use our company's products with a lower rated output power.

2) Overload Protection

Under normal operating conditions, the output circuit of these products has no protection against overload. The simplest method is add a circuit breaker to the circuit.

3) Recommended circuit

All the SVRA_D-5W & SVRB_D-5W Series have been tested according to the following recommended testing circuit before leaving factory. This series should be tested under load. Never be tested under no load (see Figure 3).

If you want to further decrease the output ripple, you can increase capacitance properly or choose capacitors with low ESR. However, the capacitance can't exceed the maximum capacitor load in the list (Table 1).

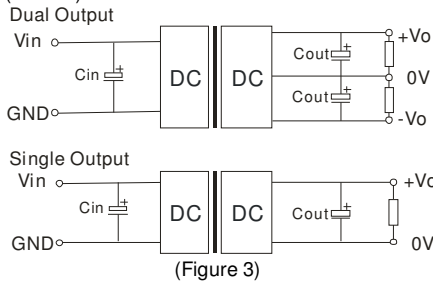

EXTERNAL CAPACITOR TABLE (TABLE 1)

Capacitance		Cout# (μF)	Cin(μF)
Output Voltage			
Single	5V	220	100
	12V,15V	100	
	24V	47	
Dual	$\pm 5V$	100	
	$\pm 12V, \pm 15V$	47	
	$\pm 24V$	22	

Note: # For each output.

4) No parallel connection or plug and play

Note:

- The load shouldn't be less than 10%, otherwise ripple will increase dramatically. Operation under minimum load will not damage the converter; However, they may not meet all specification listed, and that will reduce the life of product.
- Max. Capacitive Load tested at nominal input voltage, full load and constant resistive load.
- All specifications measured at $T_a=25^\circ C$, humidity<75%, nominal input voltage and rated output load unless otherwise specified.
- In this datasheet, all the test methods of indications are based on corporate standards.
- Only typical models listed, other models may be different, please contact our technical person for more details.
- Our company offer custom products.
- Specifications subject to change without notice.