

# SD-3W Series

3W 2:1 Regulated Single & Dual output

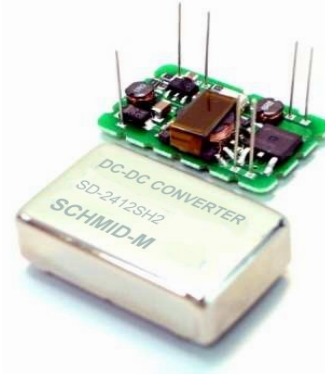

## Features

- Wide 2:1 Input Range
- Full SMD Technology
- 1500 VDC Isolation, Up to 3500 VDC
- Continuous Short Circuit Protection
- Efficiency up to 82%
- -40 ~ 85°C Operation Temperature Range
- Metal Case Standard, Optional Plastic Case

The SD series is a family of cost effective 3W single & dual output DC-DC converters. These converters are consisted with Nickel-coated copper in a 24-pin DIL package with high performance features such as 1500 VDC ~ 3500VDC input/output isolation voltage, continuous short circuit protection with automatic restart and tight line / load regulation. Devices are encapsulated using flame retardant resin. Input voltages of 12,24 and 48 with output voltage of 3.3,5,9,12,15, 24,  $\pm 3.3$ ,  $\pm 5$ ,  $\pm 9$ ,  $\pm 12$ ,  $\pm 15$  and  $\pm 24$  Vdc. High performance features include high efficiency operation up to 82% and output voltage accuracy of  $\pm 1\%$  maximum.

All specifications typical at Ta=25°C, nominal input voltage and full load unless otherwise specified

OUTPUT SPECIFICATIONS	
Voltage accuracy	$\pm 1\%$
Line regulation	$\pm 0.5\%$
Load regulation	$\pm 0.5\%$ (Output 3.3V / $\pm 3.3$ V Model) $\pm 1.5\%$
Ripple & noise(20 MHz bandwidth)(1)	60mV pk-pk
Short circuit protection	Indefinite(Automatic Recovery)
Temperature coefficient	$\pm 0.02\%/^{\circ}\text{C}$
Capacitor load(2)	See table

INPUT SPECIFICATIONS	
Voltage Range	See table
Max. Input Current	See table
No-Load Input Current	See table
Input Filter	PI Type
Input Reflected Ripple Current(3)	35mA pk-pk

GENERAL SPECIFICATIONS	
Efficiency	See table, typ
I/O Isolation Voltage(3 sec)	
Input/Output	1500~3500Vdc
Metal Case/Input & Output	1000Vdc
I/O Isolation Capacitance	470 pF Typ.
I/O Isolation Resistance	1000M Ohm
Switching Frequency	Typical 266kHz
Humidity	95% rel H
Reliability Calculated MTBF(MIL-HDBK-217 F)	>1,121 Mhrs
Safety Standard : (designed to meet)	IEC 60950-1:2001

PHYSICAL SPECIFICATIONS	
Case Material	Nickel-coated Copper
Base Material	Non-conductive Black Plastic(UL94V-0 rated)
Pin Material	$\varnothing 0.5\text{mm}$ Brass Solder-coated
Potting Material	Epoxy (UL94V-0 rated)
Weight	17.0g(Metal Case)/13.5g(Plastic Case)
Dimensions	1.25"x0.8"x0.4"

ENVIRONMENT SPECIFICATIONS	
Operating Temperature	-40°C~85°C(See Derating Curve)
Maximum Case Temperature	100°C
Storage Temperature	-40°C~125°C
Cooling	Nature Convection

ABSOLUTE MAXIMUM RATINGS(4)	
These are stress ratings. Exposure of devices to any of these conditions may adversely affect long-term reliability.	
Input Voltage(100mS)	
12 Modes	-0.7~24 Vdc
24 Modes	-0.7~40 Vdc
48 Modes	-0.7~80 Vdc
Lead Soldering Temperature (1.5mm from case 10sec.)	260°C

The information and specifications contained in this data sheet are believed to be correct at time of publication. However, Schmid-Multitech GmbH accepts no responsibility for consequences arising from printing errors or inaccuracies. Specifications are subject to change without notice. No rights under any patent accompany the sale of any such product(s) or information contained herein.

## SD - 3W 2:1 Regulated Single & Dual output

### PARTNUMBER STRUCTURE

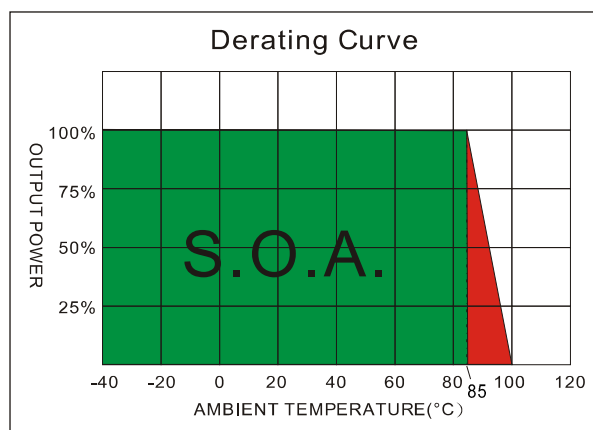
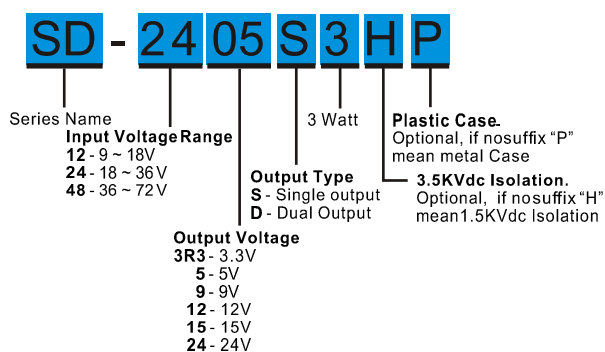

## MODEL SELECTION GUIDE

MODEL NUMBER	INPUT Voltage Range (Vdc)	INPUT Current		OUTPUT Voltage (Vdc)	OUTPUT Current		EFFICIENCY @FL(%)	Capacitor Load(µF)
		No-Load (mA)	Full Load (mA)		Min. load (mA)	Full load (mA)		
SD-123R3S3	9-18	22	343	3.3	0	900	72	470
SD-1205S3	9-18	22	328	5	0	600	76	470
SD-1209S3	9-18	22	320	9	0	333	78	68
SD-1212S3	9-18	22	312	12	0	250	80	47
SD-1215S3	9-18	22	312	15	0	200	80	47
SD-1224S3	9-18	22	313	24	0	125	80	22
SD-123R3D3	9-18	22	343	±3.3	0	±450	72	±220
SD-1205D3	9-18	22	328	±5	0	±300	76	±220
SD-1209D3	9-18	22	312	±9	0	±167	80	±33
SD-1212D3	9-18	22	312	±12	0	±125	80	±22
SD-1215D3	9-18	22	312	±15	0	±100	80	±22
SD-1224D3	9-18	22	313	±24	0	±63	80	±10
SD-243R3S3	18-36	12	171	3.3	0	900	72	470
SD-2405S3	18-36	12	164	5	0	600	76	470
SD-2409S3	18-36	12	160	9	0	333	78	68
SD-2412S3	18-36	12	156	12	0	250	80	47
SD-2415S3	18-36	12	152	15	0	200	82	47
SD-2424S3	18-36	12	153	24	0	125	82	22
SD-243R3D3	18-36	12	171	±3.3	0	±450	72	±220
SD-2405D3	18-36	12	160	±5	0	±300	78	±220
SD-2409D3	18-36	12	156	±9	0	±167	80	±33
SD-2412D3	18-36	12	152	±12	0	±125	82	±22
SD-2415D3	18-36	12	152	±15	0	±100	82	±22
SD-2424D3	18-36	12	153	±24	0	±63	82	±10
SD-483R3S3	36-72	8	86	3.3	0	900	72	470
SD-4805S3	36-72	8	82	5	0	600	76	470
SD-4809S3	36-72	8	80	9	0	333	78	68
SD-4812S3	36-72	8	78	12	0	250	80	47
SD-4815S3	36-72	8	78	15	0	200	80	47
SD-4824S3	36-72	8	78	24	0	125	80	22

Suffix "H" means 3.5KVdc isolation

Suffix "P" means Plastic case instead of standard Metal Case

*SD - 3W 2:1 Regulated Single & Dual output*

MODEL NUMBER	INPUT Voltage Range (Vdc)	INPUT Current		OUTPUT Voltage (Vdc)	OUTPUT Current		EFFICIENCY @FL(%)	Capacitor Load(uF)
		No-Load (mA)	Full Load (mA)		Min. load (mA)	Full load (mA)		
SD-483R3D3	36-72	8	86	±3.3	0	±450	72	±220
SD-4805D3	36-72	8	82	±5	0	±300	76	±220
SD-4809D3	36-72	8	80	±9	0	±167	78	±33
SD-4812D3	36-72	8	78	±12	0	±125	80	±22
SD-4815D3	36-72	8	78	±15	0	±100	80	±22
SD-4824D3	36-72	8	78	±24	0	±63	80	±10

Suffix "H" means 3.5KVdc isolation  
 Suffix "P" means Plastic case instead of standard Metal Case

**NOTE**

1. Typical value at nominal input voltage and full load.
2. Test by nominal input voltage and constant resistor load.
3. Measured Input reflected ripple current with a simulated source inductance of 12uH.
4. Exceeding the absolute ratings of the unit could cause damage. It is not allowed for continuous operating.

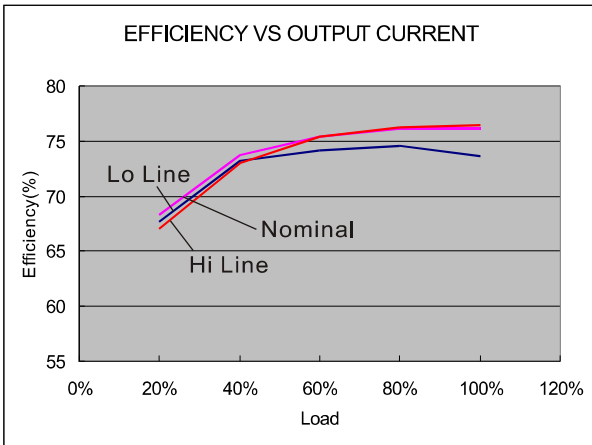

12 Models

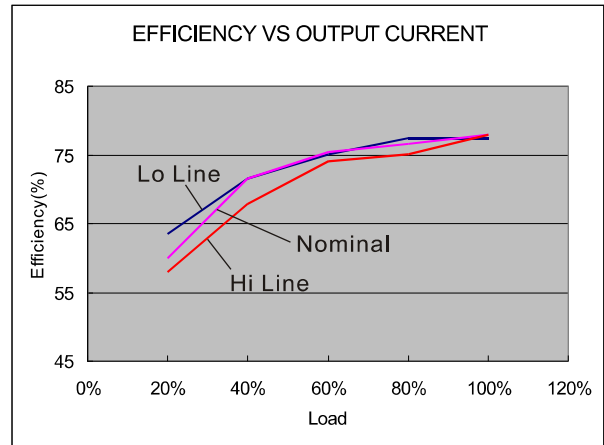

24 Models

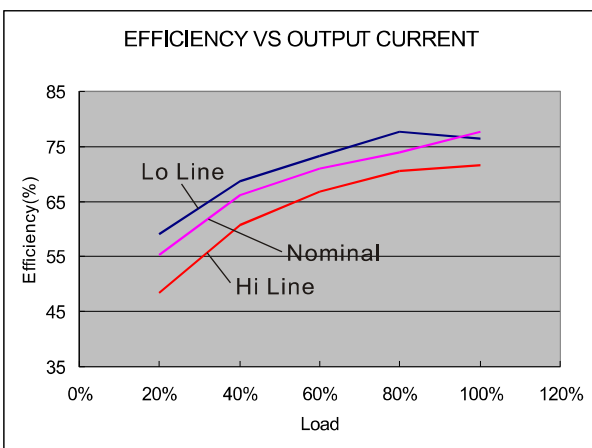

48 Models

The models listed above is just for standard type. If you need the special specification product, please contact our service member by telephone presented in shortform cover or e-mail to : info@schmid-m.com

# SD - 3W 2:1 Regulated Single & Dual output

## MECHANICAL SPECIFICATIONS

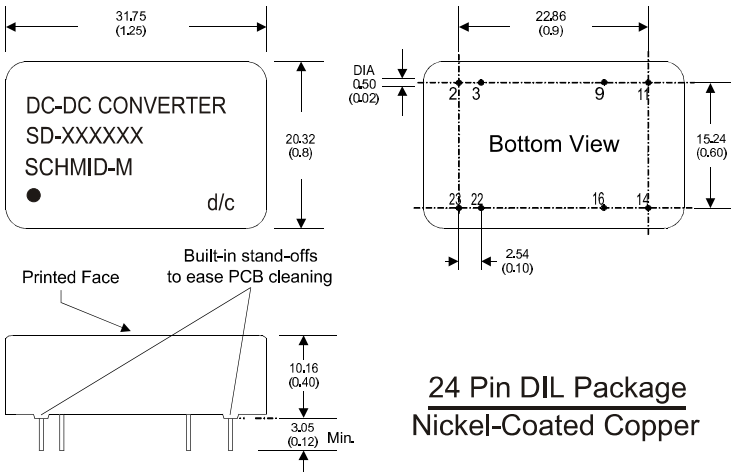

**24 Pin DIL Package  
Nickel-Coated Copper**

- Notes: All dimensions are typical in millimeters ( inches ).
1. Pin diameter:  $0.50 \pm 0.05$  (  $0.02 \pm 0.002$  )
  2. Pin pitch tolerance:  $\pm 0.35$  (  $\pm 0.014$  )
  3. Case Tolerance:  $\pm 0.5$  (  $\pm 0.02$  )

PIN CONNECTIONS		
PIN NUMBER	SINGLE	DUAL
2	-V Input	-V Input
3	-V Input	-V Input
9	N.P.	Common
11	N.C.	-V Output
14	+V Output	+V Output
16	-V Output	Common
22	+V Input	+V Input
23	+V Input	+V Input

(The Pin Connection of high isolation one is the same with normal one.)

## MECHANICAL SPECIFICATIONS

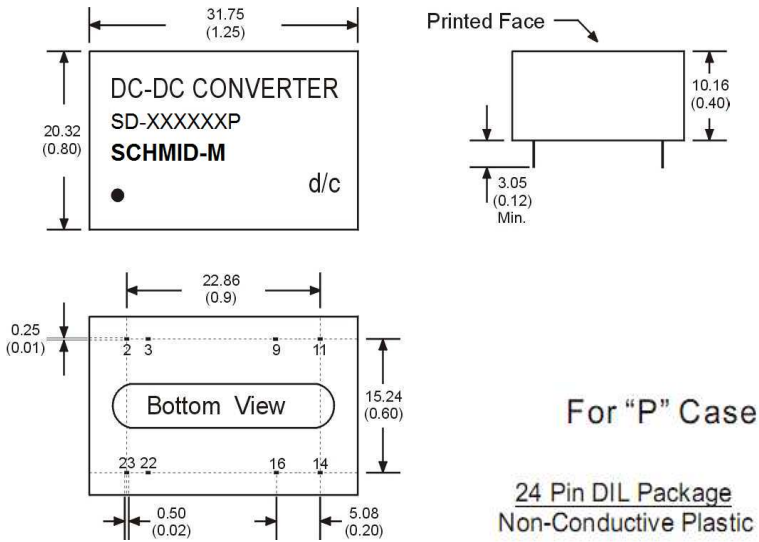

**For "P" Case**

**24 Pin DIL Package  
Non-Conductive Plastic**

- Notes: All dimensions are typical in millimeters ( inches ).
1. Pin diameter:  $0.5 \pm 0.05$  (  $0.02 \pm 0.002$  )
  2. Pin pitch tolerance:  $\pm 0.35$  (  $\pm 0.014$  )
  3. Case Tolerance:  $\pm 0.5$  (  $\pm 0.02$  )

PIN CONNECTIONS		
PIN NUMBER	SINGLE	DUAL
2	-V Input	-V Input
3	-V Input	-V Input
9	N.P.	Common
11	N.C.	-V Output
14	+V Output	+V Output
16	-V Output	Common
22	+V Input	+V Input
23	+V Input	+V Input

(The Pin Connection of high isolation one is the same with normal one.)