

SCHMID-M

SPWA_LT-1W5 & SPWB_LT-1W5 Series 1.5W, WIDE INPUT ISOLATED & REGULATED SINGLE/DUAL OUTPUT DC/DC CONVERTER MINIATURE SMD PACKAGE

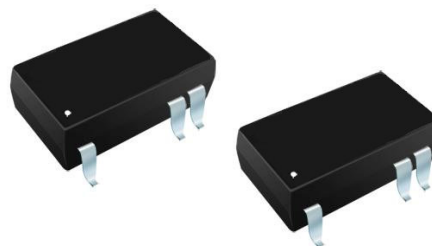

FEATURES

- SMD package
- 4:1 wide input voltage range
- Short circuit protection (automatic recovery)
- 1500VDC isolation
- Operating temperature: -40°C ~ +85°C
- No heatsink required
- No external component required
- MTBF > 1,000,000 hours
- RoHS Compliance

APPLICATIONS

The SPWA_LT-1W5 & SPWB_LT-1W5 series are specially designed for applications where a wide range input voltage power supplies are isolated from the input power supply in a distributed power supply system on a circuit board.

These products apply to:

- 1) Where the voltage of the input power supply is wide range (voltage range $\leq 4:1$);
- 2) Where isolation is necessary between input and output (isolation voltage $\leq 1500\text{VDC}$);
- 3) Where the regulation of the output voltage and the output ripple noise are demanded.

PRODUCT PROGRAM

Part Number	Input			Output			Efficiency (% Typ.)			
	Voltage (VDC)			Voltage (VDC)	Current (mA)					
	Nominal	Range	Max**		Max.	Min.				
SPWA2405LT-1W5	24	9.0-36	40	±5	±150	±15	74			
SPWA2412LT-1W5				±12	±63	±6	77			
SPWA2415LT-1W5				±15	±50	±5	75			
SPWB2403LT-1W5				3.3	500	50	71			
SPWB2405LT-1W5				5	300	30	76			
SPWB2409LT-1W5				9	167	17	76			
SPWB2412LT-1W5				12	125	12	79			
SPWB2415LT-1W5				15	100	10	80			
SPWA4805LT-1W5				48	18-72	80	±5	±150	±15	74
SPWA4812LT-1W5							±12	±63	±6	76
SPWA4815LT-1W5	±15	±50	±5				76			
SPWB4803LT-1W5	3.3	500	50				72			
SPWB4805LT-1W5	5	300	30				75			
SPWB4809LT-1W5	9	167	17				78			
SPWB4812LT-1W5	12	125	12				77			
SPWB4815LT-1W5	15	100	10				77			

**Input voltage can't exceed this value, or will cause the permanent damage.

MODEL SELECTION

SPWA 2405LT-1W5

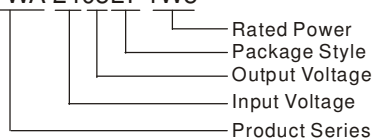

COMMON SPECIFICATIONS

Item	Test Conditions	Min.	Typ.	Max.	Units
Storage humidity				95	%
Operating Temperature		-40		85	°C
Storage Temp. range		-55		125	
Temp. rise at full load			15		
Lead temperature	1.5mm from case for 10 seconds			300	
Short circuit protection		Continuous, automatic recovery			
Cooling		Free air convection			
Case Material		Epoxy Resin (UL94-V0)			
MTBF		1000			k hours
Weight			5.2		g

ISOLATION SPECIFICATIONS

Item	Test conditions	Min.	Typ.	Max.	Units
Isolation voltage	Tested for 1 minute and 1mA max	1500			VDC
Isolation resistance	Test at 500VDC	1000			MΩ
Isolation capacitance	Input/Output, 100KHz/1V		1000		pF

OUTPUT SPECIFICATIONS

Item	Test conditions	Min.	Typ.	Max.	Units
Output power	Refer to products program	0.15		1.5	W
Positive voltage accuracy	Refer to recommended circuit		±1	±3	%
Negative voltage accuracy	Refer to recommended circuit		±3	±5	
Load regulation	From 10% to 100% load		±0.5	±1.5*	
Line regulation	Input voltage from low to high		±0.2	±0.75	
Temperature Drift (Vout)	Refer to recommended circuit			±0.03	%/°C
Output ripple & noise**	20MHz Bandwidth		35	100	mVp-p
Switching Frequency	100% load, input voltage range		550		kHz

*Dual output models unbalanced load: ±5%.

**Test ripple and noise by "parallel cable" method. See detailed operation instructions at Testing of Power Converter section, application notes.

TYPICAL TEMPERATURE CURVE

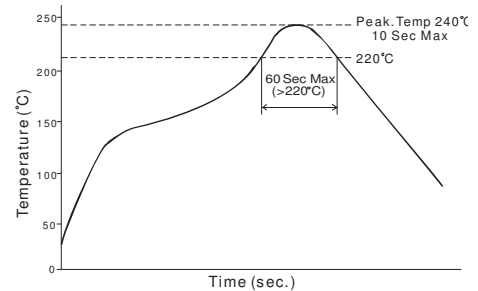
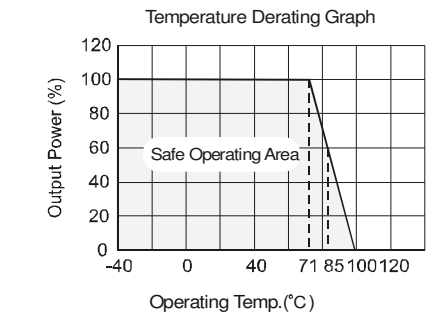

Remark:

The curve applies only to the hot air reflow soldering

APPLICATION NOTE

1) Requirement On Output Load

In order to ensure the product operate efficiently and reliably, in addition to a max load (namely full load), a minimum load is specified for this kind of DC/DC converter. Make sure the specified range of input voltage is not exceeded, the minimum output load **no less than 10% load**. If the actual load is less than the specified minimum load, the output ripple may increase sharply while its efficiency and reliability will reduce greatly. If the actual output power is very small, please add an appropriate resistor as extra loading, or contact our company for other lower output power products.

2) Recommended Circuit

All the S PWA_LT-1W5 & SPWB_LT-1W5 series have been tested according to the following recommended testing circuit before leaving factory. This series should be tested under load (see Figure 1).

If you want to further decrease the input/output ripple, you can increase capacitance properly or choose capacitors with low ESR. However, the capacitance of the output filter capacitor must be proper. If the capacitance is too big, a startup problem might arise. For every channel of output, provided the safe and reliable operation is ensured, the maximum capacitance of its filter capacitor sees (Table 1). General:

$$C_{in}: 10\mu F \sim 47\mu F$$

$$C_{out}: 10\mu F/100mA$$

3) Input Current

When it is used in unregulated power supply, be sure that the fluctuating range of the power supply and the rippled voltage do not exceed the module standard. Input current of power supply should afford the flash startup current of this kind of DC/DC module (Figure 2)

$$\text{General: } I_p \leq 1.6 \cdot I_{in-max}$$

4) No parallel connection or plug and play

RECOMMENDED CIRCUIT

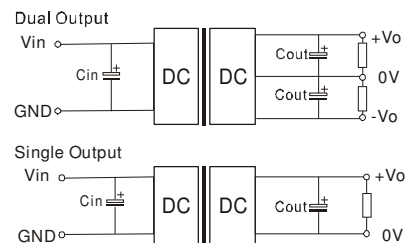

(Figure 1)

Output External Capacitor Table (Table 1)

Single Vout (VDC)	Cout (μF)	Dual Vout (VDC)	Cout (μF)
3.3	2200	±5	680
9	680	±12	330
5	1000	±15	220
12	470	-	-
15	330	-	-

OUTLINE DIMENSIONS & PIN CONNECTIONS

MECHANICAL DIMENSIONS

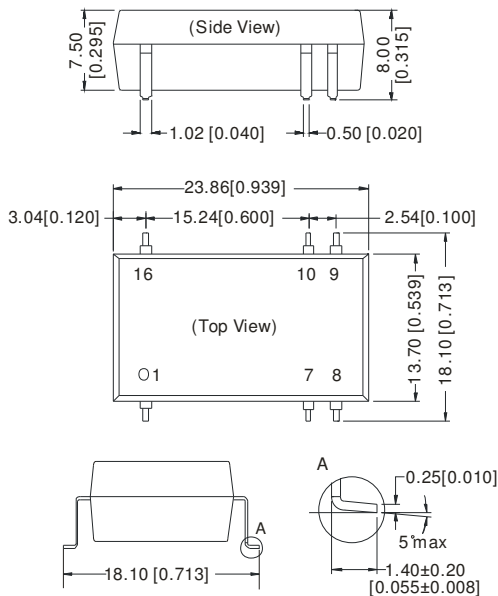

FOOTPRINT DETAILS		
Pin	Single	Dual
1	GND	GND
7	NC	NC
8	NC	0V
9	+Vo	+Vo
10	0V	-Vo
16	Vin	Vin

NC: No connection

Note:
 Unit: mm[inch]
 Pin section tolerances: ± 0.10 mm [± 0.004 inch]
 General tolerances: ± 0.25 mm [± 0.010 inch]

RECOMMENDED FOOTPRINT(TOP VIEW)

DUAL/SINGLE OUTPUT

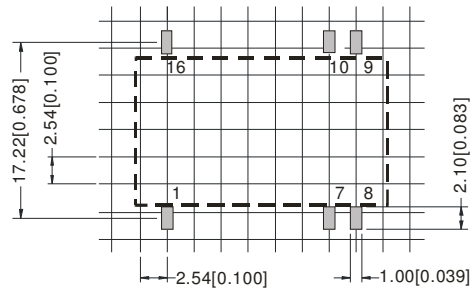

TUBE OUTLINE DIMENSIONS

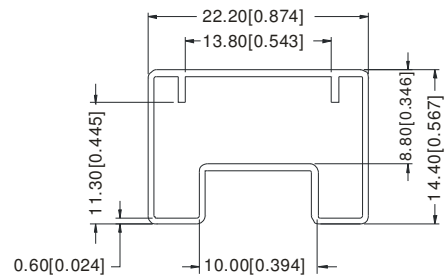

Note:

Unit :mm[inch]

General tolerances: ± 0.50 mm [± 0.020 inch]

L=530mm[20.866inch] pcs/tube: 21

L=220mm[8.661inch] pcs/tube: 8

Note:

1. The load shouldn't be less than 10%, otherwise ripple will increase dramatically.
2. Operation under 10% load will not damage the converter; However, they may not meet all specification listed.
3. Capacitor MAX load tested at input voltage range and full load.
4. All specifications measured at $T_a=25^\circ\text{C}$, humidity<75%, nominal input voltage and rated output load unless otherwise specified.
5. Only typical models listed, other models may be different, please contact our technical person for more details.
6. In this datasheet, all the test methods of indications are based on corporate standards.