

**MAIN FEATURES**

VERY ROBUST, VERSATILE, MULTI WAFER, UP TO 24 POSITIONS

- 25'000 switching cycles with up to 20 Ncm switching torque
- Gold plated contacts: 3 micron
- Optional IP68 front panel sealing
- Operating temperature range: -40° to +85°C
- Various options and customizations

**PRODUCT VARIETY**

- Soldering eyelets or pins for PCB
- From 1 x 24 to 6 x 3 poles/positions per wafer
- Up to 8 wafers
- Indexing angle 15° or 30°
- Shorting or non-shorting
- Switching torque 1.5, 8, 15 or 20 Ncm
- Front panel sealing IP60 or IP68
- Configurable end-stops
- Shaft diameter: 6 mm or ¼"
- Shaft length

**TYPE 04****POSSIBLE CUSTOMIZATIONS**

- Shaft dimension and shape
- Bushing dimensions
- Switching torque
- Momentary contact (see page 90)
- Hollow shaft, inner shaft (see page 91)
- Others

**TYPICAL APPLICATIONS**

- Industrial controls
- Avionics, instrumentation, test systems
- Medical and audio equipment
- Construction

**1 PREFERENCE TYPES SELECTION CHART**

<sup>1</sup> For other types/opions, see type key.

**INDEXING ANGLE 15°, SHORTING (ONLY)**

CONTACT ARRANGEMENT	NUMBER OF WAFERS	FUNCTION (POLES X POSITIONS)	STANDARD TYPE KEY	
			WITH SOLDER EYELETS	WITH PINS FOR PCB
	1—H	1 x 24, endless rotating	04-1103	04-1103-20
	2—HH	2 x 24, endless rotating	04-2103	-
	3—HHH	3 x 24, endless rotating	04-3103	-
	4—HHHH	4 x 24, endless rotating	04-4103	-
	1—H	1 x 24	04-1133	04-1133-20
	2—HH	2 x 24	04-2133	-
	3—HHH	3 x 24	04-3133	-
	4—HHHH	4 x 24	04-4133	-
	1—H	2 x 11	04-1213	04-1213-20
	2—HH	4 x 11	04-2213	--
	3—HHH	6 x 11	04-3213	-
	4—HHHH	8 x 11	04-4213	-
	1—H	3 x 7	04-1373	04-1373-20
	2—HH	6 x 7	04-2373	-
	3—HHH	9 x 7	04-3373	-
	4—HHHH	12 x 7	04-4373	-
	1—H	4 x 5	04-1453	04-1453-20
	2—HH	8 x 5	04-2453	-
	3—HHH	12 x 5	04-3453	-
	4—HHHH	16 x 5	04-4453	-
	1—H	6 x 3	04-1633	04-1633-20
	2—HH	12 x 3	04-2633	-
	3—HHH	18 x 3	04-3633	-
	4—HHHH	24 x 3	04-4633	-

**INDEXING ANGLE 30°, NON-SHORTING (SHORTING ON REQUEST)**

CONTACT ARRANGEMENT	NUMBER OF WAFERS	FUNCTION (POLES X POSITIONS)	STANDARD TYPE KEY	
			WITH SOLDER EYELETS	WITH PINS FOR PCB
	1—H	1 x 12, endless rotating	04-1104	04-1104-20
	2—HH	2 x 12, endless rotating	04-2104	-
	3—HHH	3 x 12, endless rotating	04-3104	-
	4—HHHH	4 x 12, endless rotating	04-4104	-
	1—H	1 x 12	04-1124	04-1124-20
	2—HH	2 x 12	04-2124	-
	3—HHH	3 x 12	04-3124	-
	4—HHHH	4 x 12	04-4124	-
	1—H	2 x 6	04-1264	04-1264-20
	2—HH	4 x 6	04-2264	-
	3—HHH	6 x 6	04-3264	-
	4—HHHH	8 x 6	04-4264	-
	1—H	3 x 4	04-1344	04-1344-20
	2—HH	6 x 4	04-2344	-
	3—HHH	9 x 4	04-3344	-
	4—HHHH	12 x 4	04-4344	-
	1—H	4 x 3	04-1434	04-1434-20
	2—HH	8 x 3	04-2434	-
	3—HHH	12 x 3	04-3434	-
	4—HHHH	16 x 3	04-4434	-
	1—H	6 x 2	04-1624	04-1624-20
	2—HH	12 x 2	04-2624	-
	3—HHH	18 x 2	04-3624	-
	4—HHHH	24 x 2	04-4624	-

**STOP SCREWS AND BUSHING NUT**

Configurable stop screws can be set on any position between 2 and the maximum. Stop screws have to be ordered separately.

	PACKAGING SIZE	ORDER NUMBER
Stop screw M1.4	10 pcs.	4124-21
Stop screw M1.4	100 pcs.	4124-20
Hex nut M10 x 0.75	10 pcs.	4124-41

## SPECIFICATIONS

### MECHANICAL DATA

Resolution:	24 positions max. (15° indexing); shorting 12 positions max. (30° indexing); non-shorting
Switching torque (new condition):	1.5, 8, 15 or 20 Ncm (+/- 25%), additional wafers may increase switching torque
Rotational life:	25'000 switching cycles min.
Fastening torque of nut:	300 Ncm max.

### ELECTRICAL DATA

Function:	From 1 x 24 to 6 x 3 poles / positions per wafer (max. 8 wafers; >8 wafers are available on request)
Switching mode:	Shorting (for 15° indexing) Non-shorting (for 30° indexing)
Load current:	2 A max. (resistive load)
Switching voltage:	42 VDC max.
Contact resistance (new condition):	10 mΩ max.
Insulation resistance (new condition):	10 <sup>12</sup> Ω min. (contact to contact / housing)
Switching capacity:	1 pF max. (contact to contact)
Dielectric withstanding voltage:	500 VDC during 60 seconds

### MATERIAL DATA

Shaft:	Stainless steel
Bushing/housing:	Zinc diecast, zinc plated and passivated
Nut:	Brass, zinc plated and passivated
Contact plating:	Gold; 3 μm
Insulation material:	Wafer: HF ceramic, rotor: Polybutylene (PB)
Soldering leads:	Alloy copper, gold plated

### ENVIRONMENTAL DATA

Operating/storage temperature range:	-40° to +85°C
IP sealing:	IP60, optional IP68 (2 bar, 1 h) shaft / front panel sealing
Vibration:	10 G <sub>rms</sub> max. @ 10 to 2000 Hz
Flammability:	UL94-HB

### PACKAGING QUANTITY

Tray:	10 pcs.
-------	---------

### SOLDERING CONDITIONS

Hand soldering:	340°C max. during 2 sec max.
Wave soldering:	280°C max. peak temperature during 5 sec max.

## SWITCHING MODES

For information about switching modes please see **technical explanations** at the end of the catalog

**DRAWINGS**

Tolerances unless otherwise specified DIN ISO 2768-1 (m)

WITH SOLDER EYELETS

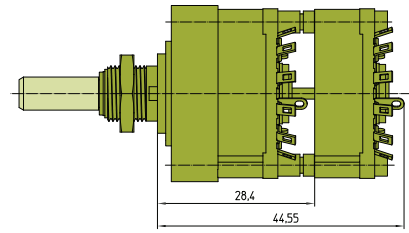
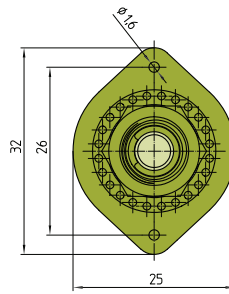
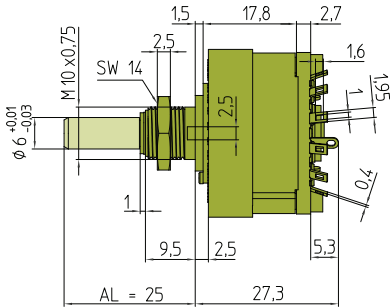

SW = key spanner

WITH PINS FOR PCB MOUNTING

**DRILLING DIAGRAM FOR 15° INDEXING ANGLE**

**DRILLING DIAGRAM FOR 30° INDEXING ANGLE**

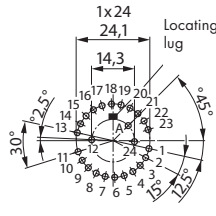
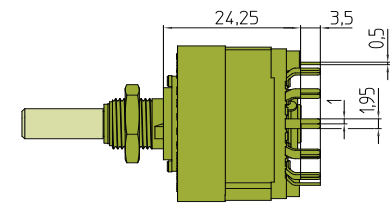

View from the shaft end

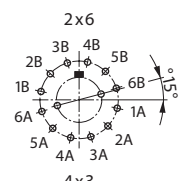
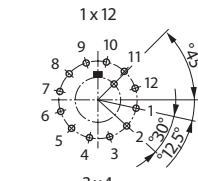
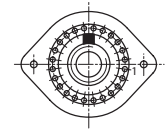

**FRONT PANEL CUT OUT**

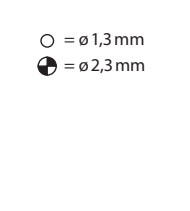
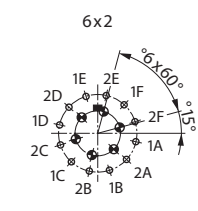
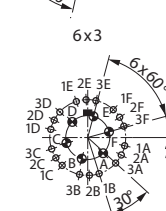
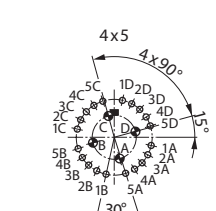
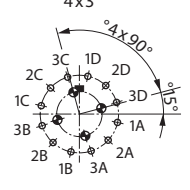
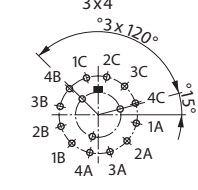
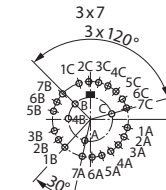
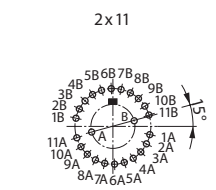
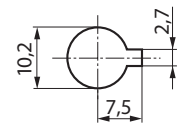

○ =  $\phi 1,3$  mm  
● =  $\phi 2,3$  mm

**SWITCH WITH MOMENTARY CONTACT (CUSTOMIZED SOLUTION)**

**EXAMPLES**

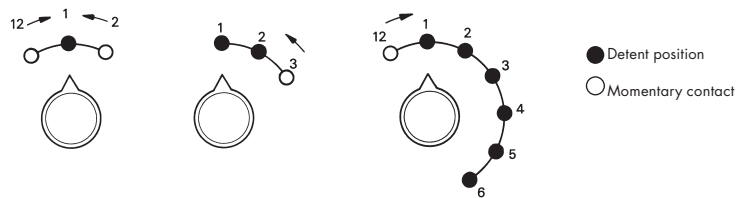

**DIMENSIONS**

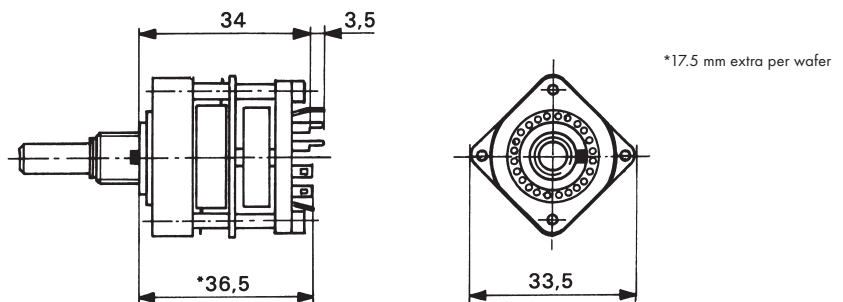

**HOLLOW SHAFT SYSTEM (CUSTOMIZED SOLUTION)**

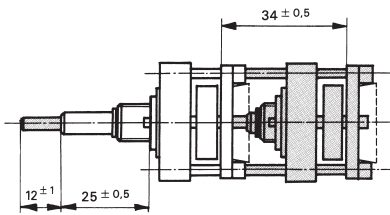
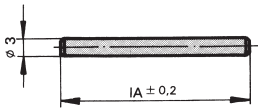
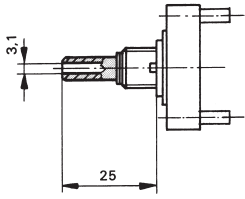

**HOLLOW SHAFT**

Available for switches up to 5 wafers; inner shaft (∅ 3 mm) to be ordered separately.

**INNER SHAFT**

For switches with mounting plate or hollow shaft; hollow shaft has to be ordered separately. Please state exact length.

**SWITCHES WITH CONCENTRIC SHAFTS**

Consisting of a hollow outer and inner shaft. The inner shaft driving a maximum of 3 wafers with 6 wipers each. Please give type description of each switch.

**SPACERS**

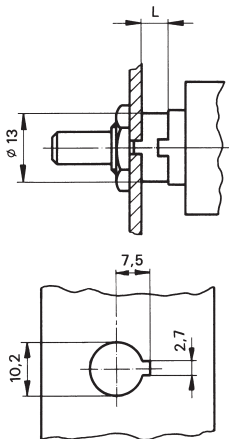

Spacers can be used in many cases instead of shortened bushes; made of glass-fibre reinforced plastic to compensate the front panel thickness; available in two standard lengths.

LENGTH L	PACKAGING UNIT	ORDER NUMBER
3.5 mm	10 pcs.	4124-31
3.5 mm	100 pcs.	4124-30
5.5 mm	10 pcs.	4124-36
5.5 mm	100 pcs.	4124-35

**TYPE KEY**



**STANDARD TYPE KEY**  
(see page 88)

**WAFER TYPE**  
- HF ceramic

**NUMBER OF WAFERS**  
(max. 8)  
> 8 on request

**NUMBER OF POLES**  
Number of Poles per Wafer

**FACTORY SET CHARACTER**  
Defined by Elma  
(See page 88, is composed of switching mode, poles and positions)

**SWITCHING MODE**  
**3** Shorting  
**4** Non-shorting (not for 15° index. angle)

**TORQUE**  
- 15 Ncm (standard)  
**M** 8 Ncm  
**N** 20 Ncm  
**R** 1.5 Ncm

**SHAFT DIAMETER**  
**0** 6 mm (standard)  
**Z** ¼"

**FACTORY SET END-STOP**

<b>00</b>	24 pos. (standard)
<b>23</b>	23 pos.
<b>22</b>	22 pos.
<b>21</b>	21 pos.
<b>20</b>	20 pos.
<b>19</b>	19 pos.
<b>18</b>	18 pos.
<b>17</b>	17 pos.
<b>16</b>	16 pos.
<b>15</b>	15 pos.
<b>14</b>	14 pos.
<b>13</b>	13 pos.
<b>12</b>	12 pos.
<b>11</b>	11 pos.
<b>10</b>	10 pos.
<b>09</b>	9 pos.
<b>08</b>	8 pos.
<b>07</b>	7 pos.
<b>06</b>	6 pos.
<b>05</b>	5 pos.
<b>04</b>	4 pos.
<b>03</b>	3 pos.
<b>02</b>	2 pos.

**SHAFT LENGTH (AL)**

**000** 25 mm (standard)  
**<sup>1</sup> xxx** Custom  
(e.g. 18.5 mm = 185)

<sup>1</sup> Customized shaft length  
Shaft length (AL) description measured from mounting face (see picture below).

Max shaft length (AL):  
Ø ¼" = 25 mm  
Ø 6 mm = 50 mm

**PIN STYLE; IP SEALING**

<b>00</b>	Eyelets, IP60
<b>20</b>	Pins for PCB, IP60
<b>30</b>	Eyelets; IP68
<b>70</b>	Pins for PCB; IP68

# TECHNICAL EXPLANATIONS

## GENERAL SWITCH KNOWLEDGE

### POSITION

A position is the mechanical detent of a switch actuator.

### DETENT

A detent is a mechanical positioning device for stopping actuator travel at each successive electrical circuit; for example, a spring-operated ball and groove.

### POLE

A pole is a single common electrical input having one or more outputs.

### WAFER, DECK OR LAYER

A wafer/deck or layer is a section what the contacts are mounted on.

### INDEXING ANGLE

An indexing angle is the number of degrees between each position.  
For example: 12 positions for a total of 360 degrees result a 30 degrees indexing angle.

### NON-SHORTING CONTACTS "BREAK BEFORE MAKE"

A non-shorting contact is also known as "break before make" and describes the action of one circuit of a pole before interrupting another of the same pole. The switch will be momentarily interrupted before it changes from position 1 to position 2 during actuation (see picture).

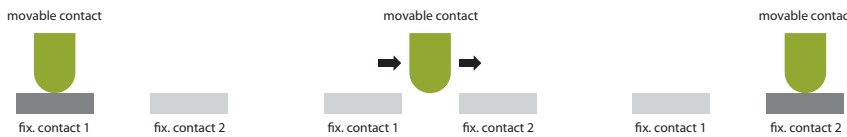

### SHORTING CONTACTS "MAKE BEFORE BREAK"

A shorting contact is also known as "make before break" and describes the action of one circuit of a pole before interrupting another of the same pole. The switch will momentarily "short" position 1 and 2 during actuation (see picture).

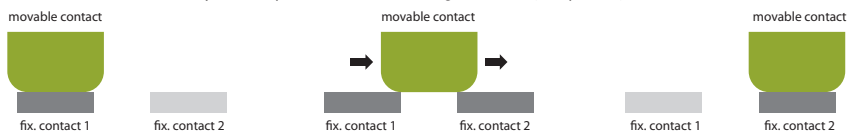

### CYCLE

A cycle is the complete sequence of indexing through all successive switch positions and returning to the original position. The rotational life from coded or selector switches are usually specified with cycles.

### REVOLUTION

A revolution is the complete sequence of indexing through all successive switch positions in the same direction. The rotational life from encoded switches are usually specified with revolutions.

### BENEFITS OF GOLD-PLATED CONTACTS

Gold-plated contacts should be used for longer rotational life, in corrosive environment or in case the switch will not be actuated for a long period of time.