

S1-0.5W Series

0.5W Unregulated Single & Dual output

SCHMID-M



Features

- 7 Pin SIL / 14 Pin DIL Package
- 1000 VDC Isolation
- Up to 6000 VDC Isolation
- Low Ripple and Noise
- Efficiency up to 79%
- -40 ~ 85°C Operation Temperature Range
- Non-Conductive Black Plastic Case



The S1 series is a family of cost effective 0.5W single & dual output DC-DC converters. These converters achieve low cost and ultra-miniature SIP 7 pin or DIP 14 pin size. Devices are encapsulated using flame retardant resin. The models operate from input voltage of 5, 12, 24, 48 Vdc with output voltage of 3.3, 5, 7.2, 9, 12, 15, 18, 24, ± 3.3 , ± 5 , ± 7.2 , ± 9 , ± 12 , ± 15 , ± 18 , ± 24 Vdc. High performance features include 1000Vdc~6000Vdc input/output isolation, high efficiency operation and output voltage accuracy of $\pm 3\%$ maximum. Standard features include an input range of $\pm 10\%$ tolerance and low output noise and ripple.

All specifications typical at Ta=25°C, nominal input voltage and full load unless otherwise specified

OUTPUT SPECIFICATIONS		PHYSICAL SPECIFICATIONS	
Output Voltage accuracy	$\pm 3\%$, max.	Case Material	Non-conductive Black Plastic(UL94V-0 rated)
Line regulation	$\pm 1.2\%$ / Per 1% Vin Change ,max.	Pin Material	0.5mm Alloy42 Solder-coated
Load regulation	(From 20% to 100% Load) $\pm 10\%$,max. (Output 3.3V Model) $\pm 20\%$,max.	Potting Material	Epoxy (UL94V-0 rated)
Ripple & noise (20 MHz bandwidth)(1)	75mV pk-pk ,max.	Weight	(SIP/2.3g) (DIP/2.7g)
Temperature coefficient	$\pm 0.02\%/^{\circ}\text{C}$	Dimensions	SIP Case 0.76"x0.24"x0.39" DIP Case 0.80"x0.40"x0.27"
Capacitor load(2)	See table ,max.		
INPUT SPECIFICATIONS		ENVIRONMENT SPECIFICATIONS	
Input Voltage Range	$\pm 10\%$	Operating Temperature	-40°C~85°C
Input Current (Full Load)	See table ,typ.	Maximum Case Temperature	100°C
Input Current (No Load)	See table ,max.	Storage Temperature	-40°C~125°C
Input Filter	Capacitors	Cooling	Nature Convection
Input Reflected Ripple Current(3)	20mA pk-pk ,typ.		
GENERAL SPECIFICATIONS		ABSOLUTE MAXIMUM RATINGS(4)	
Efficiency	See table ,typ.	These are stress ratings. Exposure of devices to any of these conditions may adversely affect long-term reliability.	
I/O Isolation Voltage(60sec)	Input/Output 1000~6000Vdc	Input Voltage(100mS)	
I/O Isolation Capacitance	60 pF typ.	5 Models	7 Vdc ,max.
I/O Isolation Resistance	1000M Ω ,min.	12 Models	15 Vdc ,max.
Switching Frequency	Variable 80kHz ,typ.	24 Models	28 Vdc ,max.
Humidity	95% rel H	48 Models	54 Vdc ,max.
Reliability Calculated MTBF(MIL-HDBK-217 F)	>1.121 Mhrs	Soldering Temperature	260°C ,max.
Safety Standard : (designed to meet)	IEC 60950-1	(1.5mm from case 10sec ,max.)	

S1 - 0.5W Unregulated Single & Dualoutput

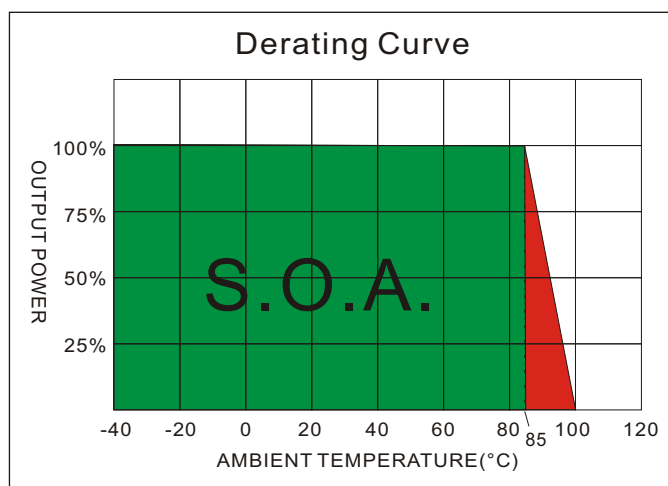
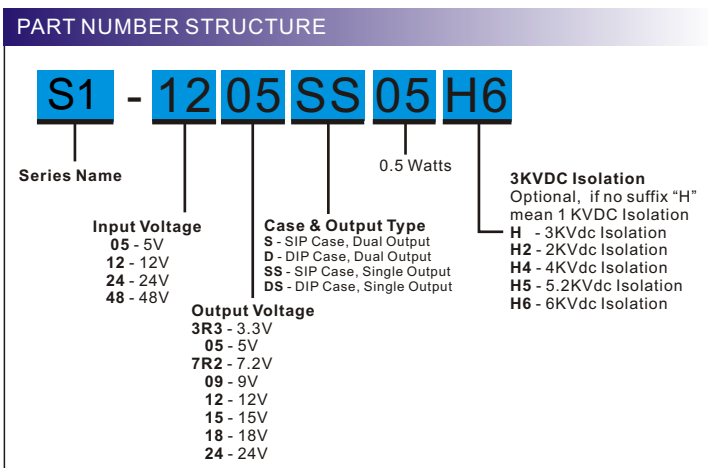

MODEL SELECTION GUIDE

MODEL NUMBER	INPUT Voltage Range (Vdc)	INPUT Current		OUTPUT Voltage (Vdc)	OUTPUT Current Full load (mA)	EFFICIENCY @FL (% ,typ.)	Capacitor Load @LF (µF ,max.)
		No-Load (mA ,max.)	Full Load (mA ,typ.)				
S1-053R3S05	5	20	147.05	±3.3	±75.7	68	±100
S1-0505S05	5	20	142.85	±5	±50	70	±100
S1-057R2S05	5	20	142.85	±7.2	±34.72	70	±100
S1-0509S05	5	20	142.85	±9	±27.7	70	±100
S1-0512S05	5	25	140.84	±12	±21	71	±100
S1-0515S05	5	25	140.84	±15	±16.66	71	±100
S1-0518S05	5	25	140.84	±18	±13.9	71	±100
S1-0524S05	5	25	138.88	±24	±10.4	72	±100
S1-123R3S05	12	15	66.13	±3.3	±75.7	63	±100
S1-1205S05	12	15	64.1	±5	±50	65	±100
S1-127R2S05	12	13	60.38	±7.2	±34.72	69	±100
S1-1209S05	12	13	60.38	±9	±27.7	69	±100
S1-1212S05	12	11	59.52	±12	±20.8	70	±100
S1-1215S05	12	11	59.52	±15	±16.7	70	±100
S1-1218S05	12	10	58.68	±18	±13.9	71	±100
S1-1224S05	12	10	58.68	±24	±10.4	71	±100
S1-243R3S05	24	15	34.72	±3.3	±75.75	60	±100
S1-2405S05	24	15	34.72	±5	±50	60	±100
S1-247R2S05	24	15	30.19	±7.2	±34.72	69	±100
S1-2409S05	24	10	30.63	±9	±27.77	68	±100
S1-2412S05	24	10	30.19	±12	±20.8	69	±100
S1-2415S05	24	10	30.19	±15	±16.7	69	±100
S1-2418S05	24	10	29.76	±18	±13.9	70	±100
S1-2424S05	24	10	29.76	±24	±10.4	70	±100
S1-483R3S05	48	8	14.88	±3.3	±75.7	70	±100
S1-4805S05	48	8	14.88	±5	±50	70	±100
S1-487R2S05	48	6	15.31	±7.2	±34.7	68	±100
S1-4809S05	48	6	15.31	±9	±27.7	68	±100
S1-4812S05	48	6	15.31	±12	±20.8	68	±100
S1-4815S05	48	5	15.78	±15	±16.7	66	±100
S1-4818S05	48	5	16.02	±18	±13.9	65	±100
S1-4824S05	48	5	16.02	±24	±10.4	65	±100

Suffix "H" means 3 KVdc isolation
Suffix "H5" means 5.2 KVdc isolation

Suffix "H2" means 2 KVdc isolation
Suffix "H6" means 6 KVdc isolation

Suffix "H4" means 4 KVdc isolation

S1 - 0.5W Unregulated Single & Dualoutput

MODEL NUMBER	INPUT Voltage Range (Vdc)	INPUT Current		OUTPUT Voltage (Vdc)	OUTPUT Current Full load (mA)	EFFICIENCY @FL (% ,typ.)	Capacitor Load @LF (μ F ,max.)
		No-Load (mA ,max.)	Full Load (mA ,typ.)				
S1-053R3D05	5	20	147.05	\pm 3.3	\pm 75.7	68	\pm 100
S1-0505D05	5	20	142.85	\pm 5	\pm 50	70	\pm 100
S1-057R2D05	5	25	136.98	\pm 7.2	\pm 34.72	73	\pm 100
S1-0509D05	5	25	136.98	\pm 9	\pm 27.7	73	\pm 100
S1-0512D05	5	20	133.33	\pm 12	\pm 20.83	75	\pm 100
S1-0515D05	5	26	135.13	\pm 15	\pm 16.66	74	\pm 100
S1-0518D05	5	25	133.33	\pm 18	\pm 13.88	75	\pm 100
S1-0524D05	5	26	133.33	\pm 24	\pm 10.4	75	\pm 100
S1-123R3D05	12	15	66.13	\pm 3.3	\pm 75.7	63	\pm 100
S1-1205D05	12	15	64.1	\pm 5	\pm 50	65	\pm 100
S1-127R2D05	12	13	60.38	\pm 7.2	\pm 34.72	69	\pm 100
S1-1209D05	12	13	60.38	\pm 9	\pm 27.7	69	\pm 100
S1-1212D05	12	11	59.52	\pm 12	\pm 20.8	70	\pm 100
S1-1215D05	12	15	59.52	\pm 15	\pm 16.67	70	\pm 100
S1-1218D05	12	10	58.68	\pm 18	\pm 13.9	71	\pm 100
S1-1224D05	12	10	58.68	\pm 24	\pm 10.4	71	\pm 100
S1-243R3D05	24	15	34.72	\pm 3.3	\pm 75.75	60	\pm 100
S1-2405D05	24	15	34.72	\pm 5	\pm 50	60	\pm 100
S1-247R2D05	24	15	30.19	\pm 7.2	\pm 34.72	69	\pm 100
S1-2409D05	24	10	30.63	\pm 9	\pm 27.77	68	\pm 100
S1-2412D05	24	10	30.19	\pm 12	\pm 20.8	69	\pm 100
S1-2415D05	24	10	31.09	\pm 15	\pm 16.67	67	\pm 100
S1-2418D05	24	10	29.76	\pm 18	\pm 13.9	70	\pm 100
S1-2424D05	24	10	29.34	\pm 24	\pm 10.41	71	\pm 100
S1-483R3D05	48	8	14.88	\pm 3.3	\pm 75.7	70	\pm 100
S1-4805D05	48	8	14.88	\pm 5	\pm 50	70	\pm 100
S1-487R2D05	48	6	15.31	\pm 7.2	\pm 34.7	68	\pm 100
S1-4809D05	48	6	15.31	\pm 9	\pm 27.7	68	\pm 100
S1-4812D05	48	6	15.31	\pm 12	\pm 20.8	68	\pm 100
S1-4815D05	48	5	15.78	\pm 15	\pm 16.7	66	\pm 100
S1-4818D05	48	5	16.02	\pm 18	\pm 13.9	65	\pm 100
S1-4824D05	48	5	16.02	\pm 24	\pm 10.4	65	\pm 100
S1-053R3SS05	5	20	142.85	3.3	151.51	70	100
S1-0505SS05	5	12	128.2	5	100	78	100
S1-057R2SS05	5	20	136.98	7.2	69.4	73	100
S1-0509SS05	5	15	126.58	9	55.55	79	100
S1-0512SS05	5	18	131.57	12	41.6	76	100
S1-0515SS05	5	18	131.57	15	33.3	76	100
S1-0518SS05	5	17	133.33	18	27.8	75	100
S1-0524SS05	5	15	136.98	24	20.8	73	100
S1-123R3SS05	12	15	62.18	3.3	151.5	67	100
S1-1205SS05	12	20	62.18	5	100	67	100
S1-127R2SS05	12	18	59.52	7.2	69.4	70	100
S1-1209SS05	12	20	57.87	9	55.55	72	100
S1-1212SS05	12	20	61.27	12	41.6	68	100
S1-1215SS05	12	20	61.27	15	33.3	68	100
S1-1218SS05	12	15	62.18	18	27.8	67	100
S1-1224SS05	12	15	64.1	24	20.8	65	100

Suffix "H" means 3 KVdc isolation
 Suffix "H5" means 5.2 KVdc isolation

Suffix "H2" means 2 KVdc isolation
 Suffix "H6" means 6 KVdc isolation

Suffix "H4" means 4 KVdc isolation

S1 - 0.5W Unregulated Single & Dualoutput

MODEL NUMBER	INPUT Voltage Range (Vdc)	INPUT Current		OUTPUT Voltage (Vdc)	OUTPUT Current Full load (mA)	EFFICIENCY @FL (% ,typ.)	Capacitor Load @LF (µF ,max.)
		No-Load (mA ,max.)	Full Load (mA ,typ.)				
S1-243R3SS05	24	10	32.05	3.3	151.51	65	100
S1-2405SS05	24	10	32.55	5	100	64	100
S1-247R2SS05	24	10	31.09	7.2	69.4	67	100
S1-2409SS05	24	10	31.09	9	55.5	67	100
S1-2412SS05	24	10	31.09	12	41.66	67	100
S1-2415SS05	24	8	30.63	15	33.33	68	100
S1-2418SS05	24	8	31.09	18	27.8	67	100
S1-2424SS05	24	6	31.09	24	20.8	67	100
S1-483R3SS05	48	7	17.36	3.3	151.5	60	100
S1-4805SS05	48	7	16.8	5	100	57	100
S1-487R2SS05	48	7	16.8	7.2	69.4	57	100
S1-4809SS05	48	6	17.36	9	55.5	60	100
S1-4812SS05	48	6	17.36	12	41.6	60	100
S1-4815SS05	48	5	17.95	15	33.3	58	100
S1-4818SS05	48	5	17.95	18	27.8	58	100
S1-4824SS05	48	5	18.6	24	20.8	56	100
S1-053R3DS05	5	20	142.85	3.3	151.51	70	100
S1-0505DS05	5	15	128.2	5	100	78	100
S1-057R2DS05	5	20	136.98	7.2	69.4	73	100
S1-0509DS05	5	15	126.58	9	55.55	79	100
S1-0512DS05	5	18	131.57	12	41.6	76	100
S1-0515DS05	5	18	131.57	15	33.3	76	100
S1-0518DS05	5	17	133.33	18	27.8	75	100
S1-0524DS05	5	15	136.98	24	20.8	73	100
S1-123R3DS05	12	15	62.18	3.3	151.5	67	100
S1-1205DS05	12	20	62.18	5	100	67	100
S1-127R2DS05	12	17	62.18	7.2	69.4	67	100
S1-1209DS05	12	20	57.87	9	55.55	72	100
S1-1212DS05	12	20	61.27	12	41.6	68	100
S1-1215DS05	12	20	61.27	15	33.3	68	100
S1-1218DS05	12	15	62.18	18	27.8	67	100
S1-1224DS05	12	15	64.1	24	20.8	65	100
S1-243R3DS05	24	10	32.05	3.3	151.51	65	100
S1-2405DS05	24	10	32.55	5	100	64	100
S1-247R2DS05	24	10	31.09	7.2	69.4	67	100
S1-2409DS05	24	10	31.09	9	55.5	67	100
S1-2412DS05	24	10	31.09	12	41.66	67	100
S1-2415DS05	24	8	30.63	15	33.33	68	100
S1-2418DS05	24	8	31.09	18	27.8	67	100
S1-2424DS05	24	6	31.09	24	20.8	67	100
S1-483R3DS05	48	7	17.36	3.3	151.5	60	100
S1-4805DS05	48	7	16.8	5	100	57	100
S1-487R2DS05	48	7	16.8	7.2	69.4	57	100
S1-4809DS05	48	6	17.36	9	55.5	60	100
S1-4812DS05	48	6	17.36	12	41.6	60	100
S1-4815DS05	48	5	17.95	15	33.3	58	100
S1-4818DS05	48	5	17.95	18	27.8	58	100
S1-4824DS05	48	5	18.6	24	20.8	56	100

Suffix "H" means 3 KVdc isolation
 Suffix "H5" means 5.2 KVdc isolation

Suffix "H2" means 2 KVdc isolation
 Suffix "H6" means 6 KVdc isolation

Suffix "H4" means 4 KVdc isolation

S1 - 0.5W Unregulated Single & Dualoutput

NOTE

1. Ripple/Noise measured with 20MHz bandwidth.
2. Tested by minimal V_{in} and constant resistive load.
3. Measured Input reflected ripple current with a simulated source inductance of $12\mu\text{H}$.
4. Exceeding the absolute ratings of the unit could cause damage. It is not allowed for continuous operating.
5. Operation under no-load conditions will not damage these devices, however they may not meet all listed specifications.
6. For reduce converter's ripple & noise, it is recommended to add a $4.7\mu\text{F}\sim 100\mu\text{F}$ ($\pm 4.7\mu\text{F}\sim \pm 68\mu\text{F}$ for dual output) capacitor in output end. For EMI performance improvement, it is recommended to add a $12\mu\text{H}$ inductor and a $10\mu\text{F}\sim 100\mu\text{F}$ capacitor in input end.

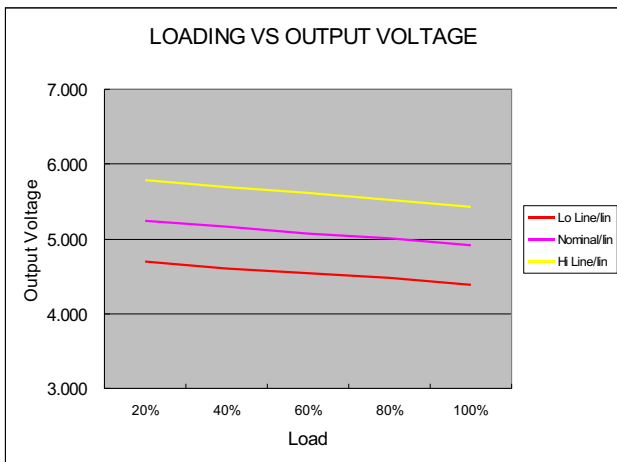

5 Models

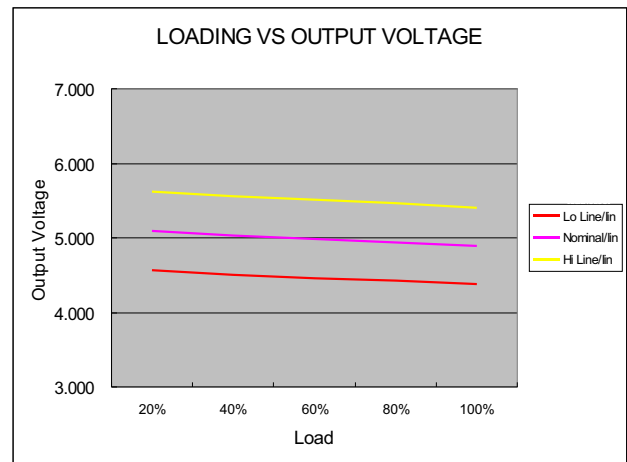

12 Models

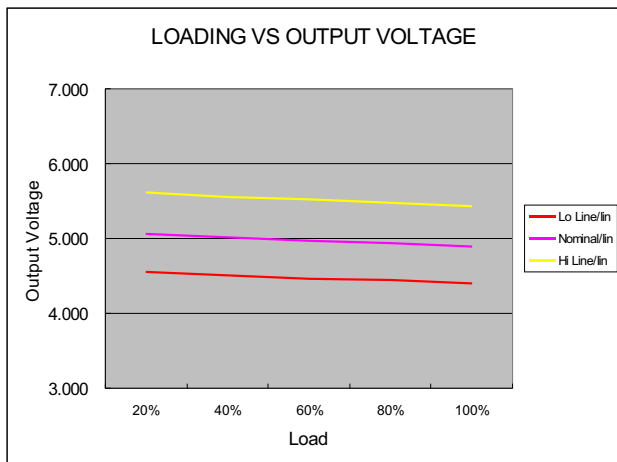

24 Models

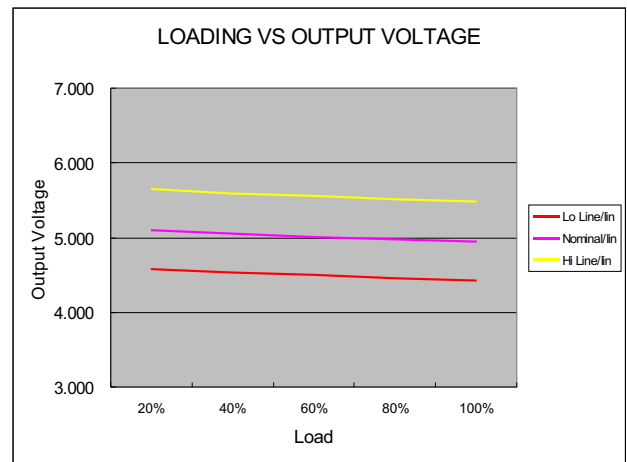

48 Models

MECHANICAL SPECIFICATIONS

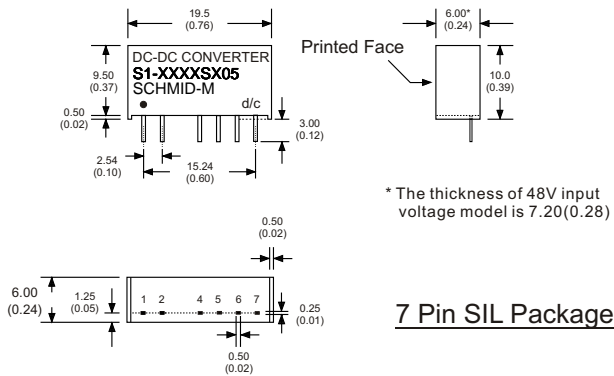

PIN CONNECTIONS				
PIN NUMBER	SINGLE	DUAL	SINGLE-H	DUAL-H
1	+V Input	+V Input	+V Input	+V Input
2	-V Input	-V Input	-V Input	-V Input
4	-V Output	-V Output	N.P.	N.P.
5	N.P.	Common	-V Output	-V Output
6	+V Output	+V Output	N.P.	Common
7	N.P.	N.P.	+V Output	+V Output

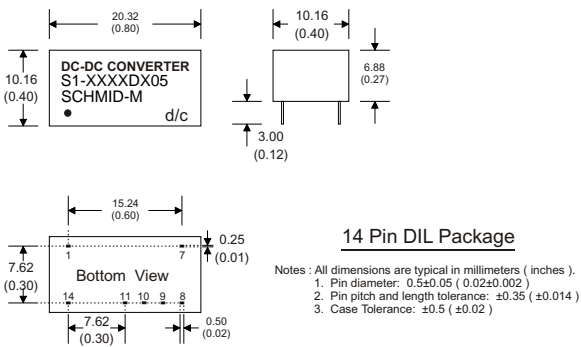

PIN CONNECTIONS				
PIN NUMBER	SINGLE	DUAL	SINGLE-H	DUAL-H
1	-V Input	-V Input	-V Input	-V Input
7	N.C.	N.C.	N.C.	N.C.
8	N.P.	Common	+V Output	+V Output
9	+V Output	+V Output	N.P.	Common
10	N.P.	N.P.	-V Output	-V Output
11	-V Output	-V Output	N.P.	N.P.
14	+V Input	+V Input	+V Input	+V Input