

TABS - TERMINALS GENERAL CATALOGUE

Edition 2017

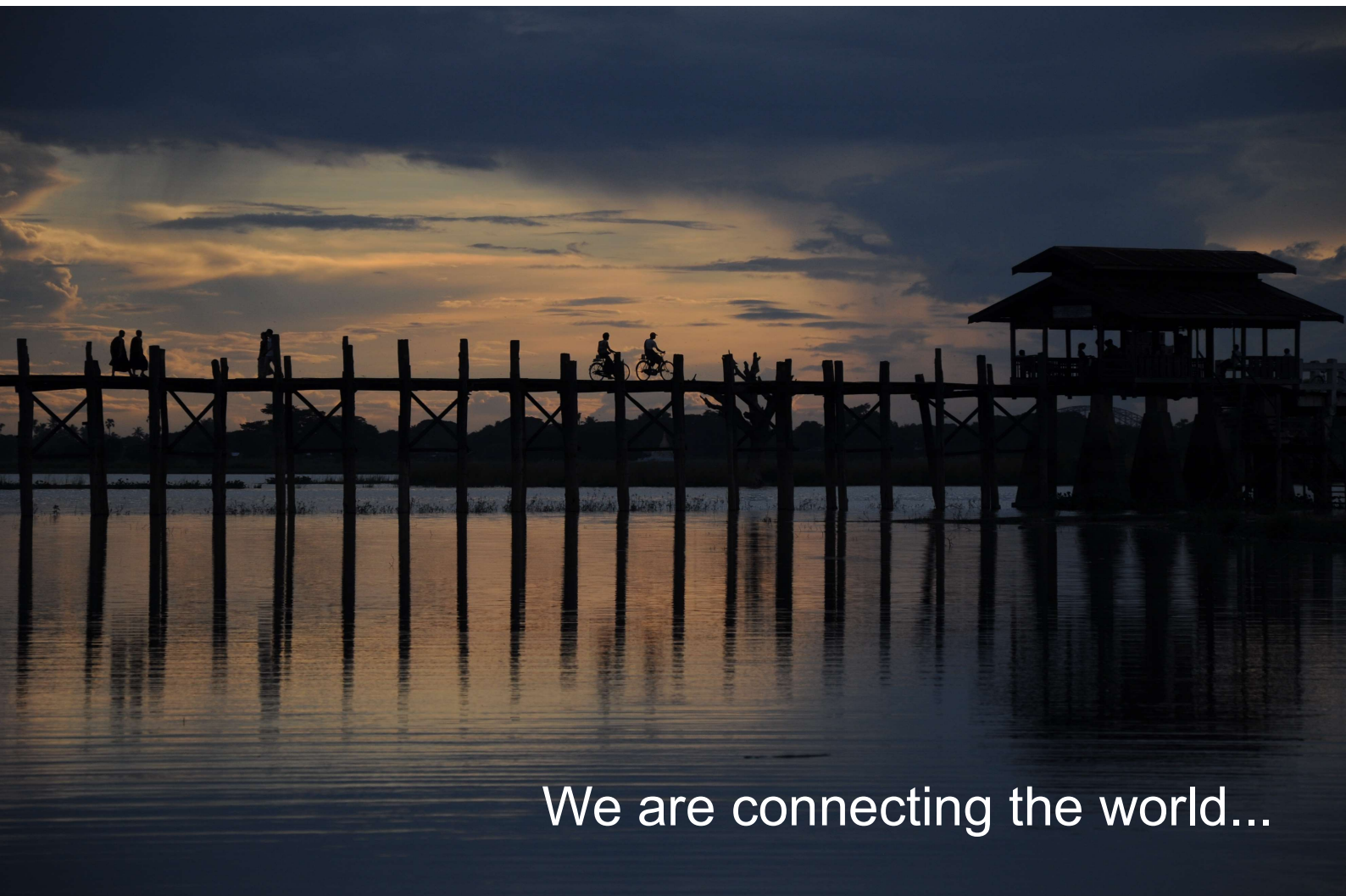

We are connecting the world...

Terminals

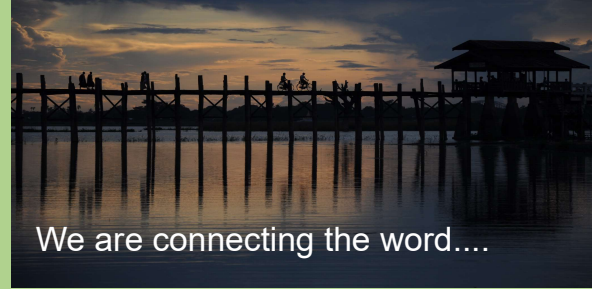

We are connecting the word....

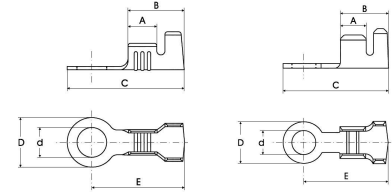
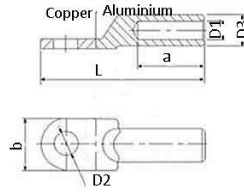
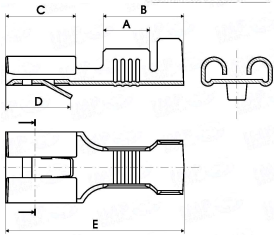

Insulated Ring Terminals

Terminal - Male 2,80 - 6,30mm

7-8

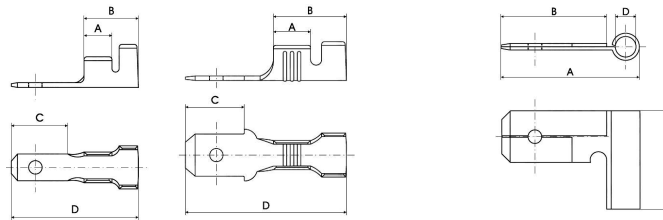
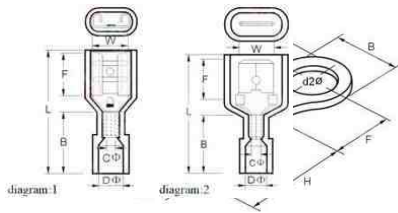

Terminals- Female 2,80 - 9,30mm

9 -10

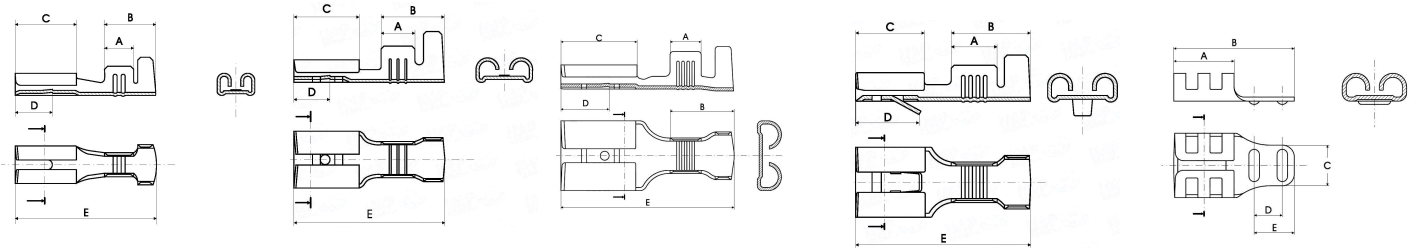

Male and Female Insulated

11

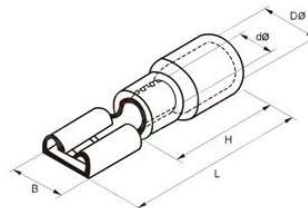
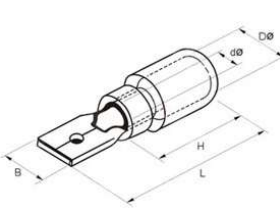

Piggy and Fully - Insulated

12

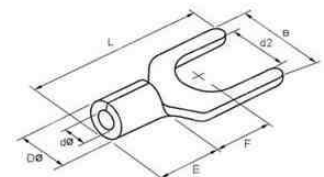
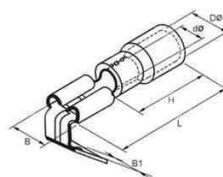
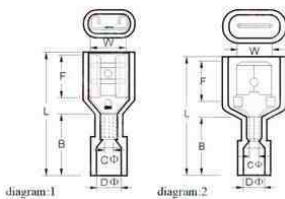

Terminals

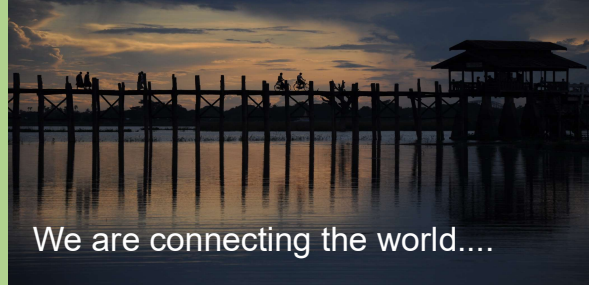

We are connecting the world...

Terminals - Fork

13

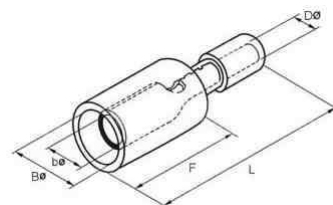
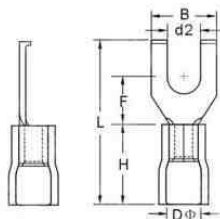
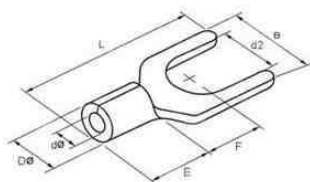

Terminals - Conjunction

14

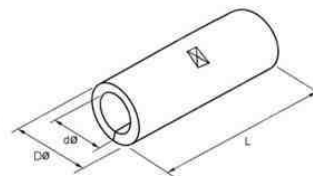
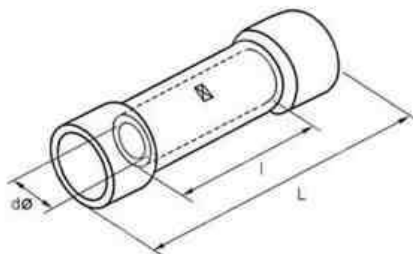
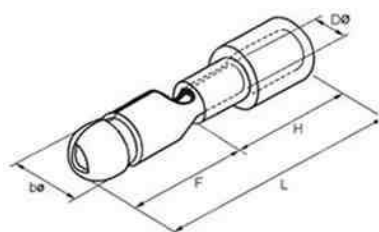

Insulated Lipped and Pin T.

15

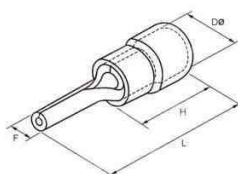
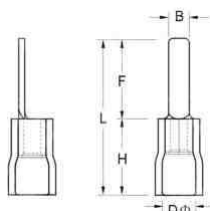

Insulated Cord End Terminals

16

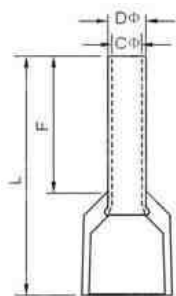

Terminals - TUBE TERMINAL

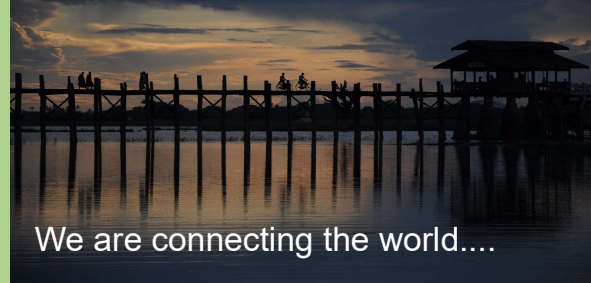

We are connecting the world....

TUBE TERMINAL SM TE01 1_____ Cupper

SM TE01 1XXXX

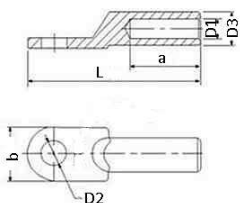

Part.No.	D2	D3	D1	L	a	b
SM TE01 14850;Copper;d-5,5mm	8,5	9	5,5	67	31	16
SM TE01 14851;Copper;d-6mm	8,5	9	6	67	31	16
SM TE01 15850;Copper;d-7mm	8,5	11	7	80	34	18
SM TE01 15100;Copper;d-8,5mm	10,5	12	8,5	79	36	20,5
SM TE01 15101;Copper;d-9,5mm	10,5	14	9,5	87	40	23
SM TE01 16120;Copper;d-11,5mm	12,5	16	11,5	95	42	26
SM TE01 16121;Copper;d-13,5mm	12,5	18	13,5	105	46	28
SM TE01 16140;Copper;d-15mm	14,5	20	15	112	48	30
SM TE01 17140;Copper;d-16,5mm	14,5	22	16,5	118	52	34
SM TE01 17160;Copper;d-18,5mm	16,5	25	18,5	125	55	37
SM TE01 17161;Copper;d-21mm	16,5	27	21	136	60	40
SM TE01 17210;Copper;d-23mm	21	30	23	160	65	45
SM TE01 18210;Copper;d-26mm	21	34	26	165	70	50
SM TE01 18211;Copper;d-29mm	21	38	29	190	75	60
SM TE01 18212;Copper;d-34mm	21	45	34	220	85	80
SM TE01 18213;Copper;d-38mm	21	50	38	260	85	80

TUBE TERMINAL SM TE01 4_____ Cupper/Aluminium

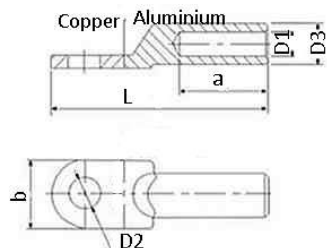

Part.No.	D2	D3	D1	L	a	b
SM TE01 44850;Copper/Al;d-6mm	8,5	10	6	70	32	16
SM TE01 45851;Copper/Al;d-7mm	8,5	12	7	75	34	18
SM TE01 45100;Copper/Al;d-8,5mm	10,5	14	8,5	85	40	20,5
SM TE01 45101;Copper/Al;d-9,5mm	10,5	16	9,5	90	42	23
SM TE01 46120;Copper/Al;d-11,5mm	12,5	18	11,5	102	47	26
SM TE01 46121;Copper/Al;d-13,5mm	12,5	21	13,5	112	50	28
SM TE01 46140;Copper/Al;d-15mm	14,5	23	15	120	53	30
SM TE01 47141;Copper/Al;d-16,5mm	14,5	25	16,5	126	55	34
SM TE01 47160;Copper/Al;d-18,5mm	16,5	27	18,5	133	58	37
SM TE01 47161;Copper/Al;d-21mm	16,5	30	21	140	60	40
SM TE01 47210;Copper/Al;d-23mm	21	34	23	165	65	45
SM TE01 48210;Copper/Al;d-26mm	21	38	26	170	70	50
SM TE01 48211;Copper/Al;d-29mm	21	42	29	190	75	60
SM TE01 48212;Copper/Al;d-34mm	21	54	34	225	80	80
SM TE01 48213;Copper/Al;d-38mm	21	60	38	270	90	100



Terminals - RING TERMINAL

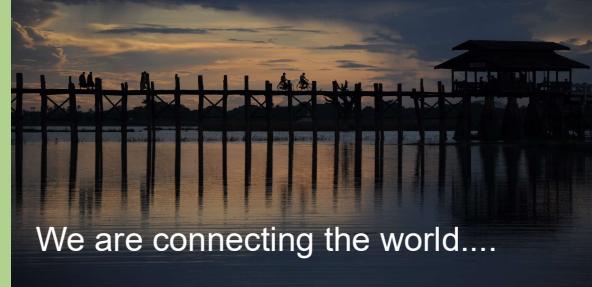

We are connecting the world....

Non Insulated Ring Terminals

SM TE01 8XXXX

Cable site 0,25-0,5mm ² ; AWG 24-22				
Part.No.	d2	D	C	AWG
SM TE01 80320; AWG 24-22; Cu Zn	3,2	5,1	11,0	24-22
SM TE0180321; AWG 24-22; Cu Zn gal Sn	3,2	5,1	11,0	24-22
Cable site 0,5-1,5mm ² ; AWG 22-16				
Part.No.	d2	D	C	AWG
SM TE01 81220; AWG 22-16; Cu Zn	2,2	4,2	11,5	22-16
SM TE01 81221; AWG 22-16; Cu Zn gal Sn	2,2	4,2	11,5	22-16
SM TE01 81260; AWG 22-16; Cu Zn	2,6	4,5	11,5	22-16
SM TE01 81261; AWG 22-16; Cu Zn gal Sn	2,6	4,5	11,5	22-16
SM TE01 81322; AWG 22-16; Cu Zn	3,2	5,3	11,0	22-16
SM TE01 81323; AWG 22-16; Cu Zn gal Sn	3,2	5,3	11,0	22-16
SM TE01 81324; AWG 22-16; Cu Zn	3,2	6,4	11,9	22-16
SM TE01 81325; AWG 22-16; Cu Zn gal Sn	3,2	6,4	11,9	22-16
SM TE01 81326; AWG 22-16; Cu Zn	3,2	8,7	20,0	22-16
SM TE01 81327; AWG 22-16; Cu Zn gal Sn	3,2	8,7	20,0	22-16
SM TE01 81360; AWG22-16; CuZn	3,6	6,0	14,2	22-16
SM TE01 81361; AWG22-16; CuZn gal Sn	4,2	6,0	11,3	22-16
SM TE01 81420; AWG 22-16; Cu Zn	4,2	4,0	11,3	22-16
SM TE01 81421; AWG 22-16; Cu Zn gal Sn	4,2	6,0	11,3	22-16
SM TE01 81422; AWG 22-16; Cu Zn	4,2	6,4	11,9	22-16
SM TE01 81423; AWG 22-16; Cu Zn gal Sn	4,2	6,4	11,9	22-16
SM TE01 81424; AWG 22-16; Cu Zn	4,2	8,7	20,0	22-16
SM TE01 81425; AWG 22-16; Cu Zn gal Sn	4,2	8,7	20,0	22-16
SM TE01 81520; AWG 22-16; Cu Zn	5,2	6,4	11,9	22-16
SM TE01 81521; AWG 22-16; Cu Zn gal Sn	5,2	6,4	11,9	22-16
SM TE01 81522; AWG 22-16; Cu Zn	5,2	8,7	20,0	22-16
SM TE01 81523; AWG 22-16; Cu Zn gal Sn	5,2	8,7	20,0	22-16
SM TE01 81550; AWG 22-16; CuSn	5,5	11,0	28,5	22-16
SM TE01 81551; AWG 22-16; CuSn gal Sn	5,5	11,0	28,5	22-16
SM TE01 81620; AWG 22-16; Cu Zn	6,2	8,7	20,0	22-16
SM TE01 81621; AWG 22-16; Cu Zn gal Sn	6,2	8,7	20,0	22-16
SM TE01 81630; AWG 22-16; CuSn	6,3	11,0	28,5	22-16
SM TE01 81631; AWG 22-16; CuSn gal Sn	6,3	11,0	28,5	22-16

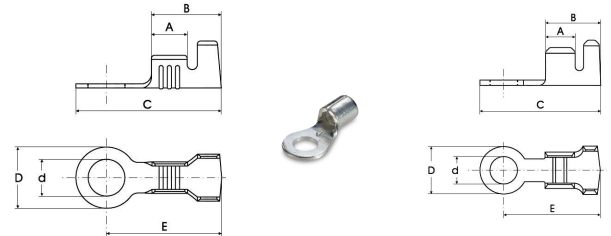

Cable site 0,75-2mm ² ; AWG 22-16				
Part.No.	d2	D	C	AWG
SM TE01 81720; AWG 22-16; CuZn	7,2	13,8	25,4	22-16
SM TE01 81720; AWG 22-16; CuZn gal Sn	7,2	13,8	25,4	22-16
SM TE01 81820; AWG 22-16; CuZn	8,2	13,8	25,4	22-16
SM TE01 81820; AWG 22-16; CuZn gal Sn	8,2	13,8	25,0	22-16
Cable site 1-2,5mm ² ; AWG 16-14				
Part.No.	d2	D	C	AWG
SM TE01 82320; AWG 16-24; Cu Zn	3,2	8,7	20,0	16-14
SM TE01 82321; AWG 16-24; Cu Zn gal Sn	3,2	8,7	20,0	16-14
SM TE01 82420; AWG 16-14; CuZn	4,2	11,0	20,4	16-14
SM TE01 82420; AWG 16-24; Cu Zn	4,2	8,7	20,0	16-14
SM TE01 82421; AWG 16-14; CuZn gal Sn	4,2	8,7	20,0	16-14
SM TE01 82421; AWG 16-24; Cu Zn gal Sn	4,2	8,7	20,0	16-14
SM TE01 82520; AWG 16-14; CuZn	5,2	11,0	20,4	16-14
SM TE01 82521; AWG 16-14; CuZn gal Sn	5,2	11,0	20,4	16-14
SM TE01 82522; AWG 16-24; Cu Zn	5,2	8,7	20,0	16-14
SM TE01 82523; AWG 16-24; Cu Zn gal Sn	5,2	8,7	20,0	16-14
SM TE01 82620; AWG 16-24; Cu Zn	6,2	8,7	20,0	16-14
SM TE01 82621; AWG 16-24; Cu Zn gal Sn	6,2	8,7	20,0	16-14
SM TE01 82640; AWG 16-14; CuZn	6,4	11,0	20,4	16-14
SM TE01 82641; AWG 16-14; CuZn gal Sn	6,4	11,0	20,4	16-14
Cable site 3-6mm ² ; AWG 12-10				
Part.No.	d2	D	C	AWG
SM TE01 82840; AWG 12-10; CuZn	8,4	14,0	31,4	12-10
SM TE01 82840; AWG 12-10; CuZn	8,4	14,0	31,4	12-10
SM TE01 82841; AWG 12-10; CuZn gal Sn	8,4	14,0	31,4	12-10
SM TE01 82841; AWG 12-10; CuZn gal Sn	8,4	14,0	31,4	12-10
SM TE01 84100; AWG 12-10; CuZn	10,2	16,0	32,4	12-10



Terminals - RING TERMINAL

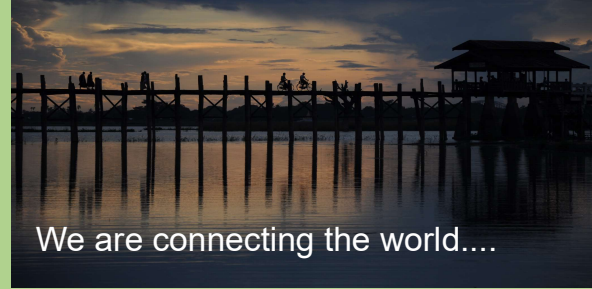

Non Insulated Ring Terminals

SM TE01 8XXXX

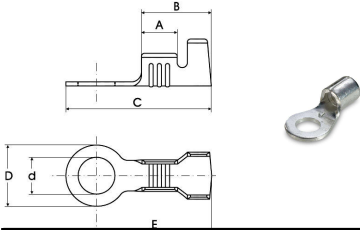

SM TE01 86321 Part Numering System

TE 01 RING Terminal

Diameter - d (ring terminals)
 22 - 2,2mm
 32 - 3,2mm
 42 - 4,2mm
 52 - 5,2mm.....
 63 - 6,3mm
 72 - 7,2mm
 10 - 10,2mm

Cable size: 0 - AWG 24-22;0.25-0.2mm²
 1 - AWG 22-16; 0.5-1.5mm²
 2 - AWG 16-14; 1.5-2.5mm²
 3 - AWG 14-12; 2.5-4mm²
 4 - AWG 12-10; 4-6mm²
 5 - AWG 10-8; 6-10mm²
 6 - AWG 8-6; 10-16mm²
 7 - AWG 6-4; 16-25mm²
 8 - AWG 4-2; 25-50mm²

8 - RING TERMINALS Non Insulated
 9 - RING TERMINALS Insulated

SM - Schmid-Multitech

Cable site 3-6mm ² ; AWG 12-10				
Part.No.	d2	D	C	AWG
SM TE01 84101; AWG 12-10; CuZn gal Sn	10,2	16,0	32,4	12-10
SM TE01 84120; AWG 12-10; CuZn	12,2	16,0	32,4	12-10
SM TE01 84121; AWG 12-10; CuZn gal Sn	12,2	16,0	32,4	12-10
SM TE01 84420; AWG 12-10; CuZn	4,2	8,7	20,0	12-10
SM TE01 84421; AWG 12-10; CuZn gal Sn	4,2	8,7	20,0	12-10
SM TE01 84422; AWG12-10;CuZn	4,2	8,8	24,3	12-10
SM TE01 84423; AWG12-10;CuZn gal Sn	4,2	8,8	24,3	12-10
SM TE01 84520; AWG 12-10; CuZn	5,2	8,7	20,0	12-10
SM TE01 84521; AWG 12-10; CuZn gal Sn	5,2	8,7	20,0	12-10
SM TE01 84522; AWG12-10;CuZn	5,2	8,8	24,3	12-10
SM TE01 84523; AWG12-10;CuZn gal Sn	5,2	8,8	24,3	12-10
SM TE01 84620; AWG 12-10; CuZn	6,2	8,7	20,0	12-10
SM TE01 84621; AWG 12-10; CuZn gal Sn	6,2	8,7	20,0	12-10
SM TE01 84622; AWG12-10;CuZn	6,2	8,8	24,3	12-10
SM TE01 84623; AWG12-10;CuZn gal Sn	6,2	8,8	24,3	12-10
SM TE01 84624; AWG12-10;CuZn	6,2	12,0	25,4	12-10
SM TE01 84625; AWG12-10;CuZn gal Sn	6,2	12,0	25,4	12-10
SM TE01 84720; AWG 12-10; CuZn	7,2	14,0	31,0	12-10
SM TE01 84721; AWG 12-10; CuZn gal Sn	7,2	14,0	31,0	12-10
SM TE01 84722; AWG12-10;CuZn	7,2	12,0	25,4	12-10
SM TE01 84725; AWG12-10;CuZn gal Sn	7,2	12,0	25,4	12-10
SM TE01 84820; AWG 12-10; CuZn	8,2	14,0	31,0	12-10
SM TE01 84821; AWG 12-10; CuZn gal Sn	8,2	14,0	31,0	12-10
SM TE01 84822; AWG12-10;CuZn	8,2	12,0	25,4	12-10
SM TE01 84825; AWG12-10;CuZn gal Sn	8,2	12,0	25,4	12-10
Cable site 3-6mm ² ; AWG 12-10				
Part.No.	d2	D	C	AWG
SM TE01 85100; AWG10-8;CuZn	10,5	15,0	29,8	10-8
SM TE01 85430; AWG10-8;CuZn	4,3	12,0	23,8	10-8

Cable site 3-6mm ² ; AWG 12-10				
Part.No.	d2	D	C	AWG
SM TE01 85530; AWG10-8;CuZn	5,3	12,0	23,8	10-8
SM TE01 85650; AWG10-8;CuZn	6,5	12,0	23,8	10-8
SM TE01 85840; AWG10-8;CuZn	8,4	15,0	29,8	10-8
Cable site 3-6mm ² ; AWG 12-10				
Part.No.	d2	D	C	AWG
SM TE01 86100; AWG 8-6; CuZn	10,5	16,0	32,8	8-6
SM TE01 86530; AWG 8-6; CuZn	5,3	12,0	29,8	8-6
SM TE01 86620; AWG 8-6; CuZn	6,2	11,0	28,0	8-6
SM TE01 86621; AWG 8-6; CuZn gal Sn	6,2	11,0	28,0	8-6
SM TE01 86650; AWG 8-6; CuZn	6,2	12,0	29,8	8-6
SM TE01 86651; AWG 8-6; CuZn	6,5	16,0	32,8	8-6
SM TE01 86720; AWG 8-6; CuZn	7,2	11,0	28,0	8-6
SM TE01 86721; AWG 8-6; CuZn gal Sn	7,2	11,0	28,0	8-6
SM TE 01 86840; AWG 8-6; CuZn	8,4	16,0	32,8	8-6
Cable site 3-6mm ² ; AWG 12-10				
Part.No.	d2	D	C	AWG
SM TE01 87100; AWG6-4; Cu-Zn	10,5	16,5	33,7	6-4
SM TE01 87130; AWG6-4; Cu-Zn	13,0	22,0	42,5	6-4
SM TE01 87530; AWG6-4; Cu-Zn	5,3	12,2	33,2	6-4
SM TE01 87650; AWG6-4; Cu-Zn	6,5	12,2	33,2	6-4
SM TE01 87651; AWG6-4; Cu-Zn	6,5	16,5	33,7	6-4
SM TE01 87840; AWG6-4; Cu-Zn	8,4	16,5	33,7	6-4
Cable site 3-6mm ² ; AWG 12-10				
Part.No.	d2	D	C	AWG
SM TE01 88100; AWG 4-2; CuZn	10,5	22,0	39,0	4-2
SM TE01 88130; AWG 4-2; CuZn	13,5	22,0	42,7	4-2
SM TE01 88530; AWG 4-2; CuZn	5,3	15,3	39,0	4-2
SM TE01 88650; AWG 4-2; CuZn	6,5	15,3	39,0	4-2
SM TE01 88840; AWG 4-2; CuZn	8,4	15,3	39,0	4-2



Terminals - INSULATED RING

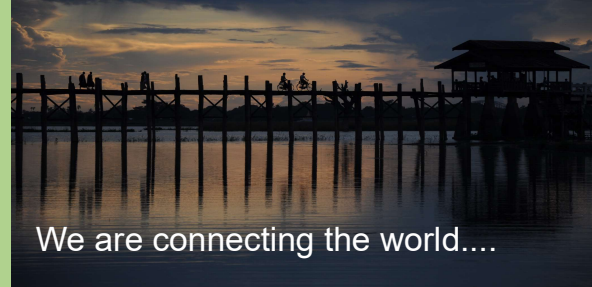

Insulated Ring Terminals

SM TE01 9XXXX

Part.No.	d2	B	L
SM TE01 91320 RED	3,2	5,7	17,8
SM TE01 91370 RED	3,7	5,7	17,8
SM TE01 91371 RED	3,7	6,6	20,1
SM TE01 91430 RED	4,3	8,0	21,5
SM TE01 91431 RED	4,3	6,6	20,1
SM TE01 91432 RED	4,3	8,0	21,5
SM TE01 91530 RED	5,3	8,0	21,5
SM TE01 91531 RED	5,3	9,8	23,0
SM TE01 91640 RED	6,4	9,8	23,0
SM TE01 91641 RED	6,4	11,6	27,5
SM TE01 91810 RED	8,1	11,6	27,5
SM TE01 91100 RED	10,5	13,6	31,6
SM TE01 91130 RED	13,0	19,2	36,0
Part.No.	d2	B	L
SM TE01 92320 BLUE	3,2	6,6	17,8
SM TE01 92370 BLUE	3,7	6,6	17,8
SM TE01 92371 BLUE	3,7	6,6	20,1
SM TE01 92372 BLUE	3,7	8,5	22,5
SM TE01 92430 BLUE	4,3	6,6	21,0
SM TE01 92431 BLUE	4,3	8,5	22,5
SM TE01 92530 BLUE	5,3	8,5	22,5
SM TE01 92531 BLUE	5,3	9,5	22,5
SM TE01 92640 BLUE	6,4	12,0	27,6
SM TE01 92810 BLUE	7,1	12,0	27,6
SM TE01 92100 BLUE	10,8	13,6	30,2
SM TE01 92130 BLUE	13,0	19,2	36,5
Part.No.	d2	B	L
SM TE01 93430 BLACK	4,3	8,0	24,5
SM TE01 93530 BLACK	5,3	8,0	24,5
SM TE01 93531 BLACK	5,3	12,0	27,9
SM TE01 93640 BLACK	6,4	12,0	27,9
Part.No.	d2	B	L
SM TE01 94370 YELLOW	3,7	7,2	21,4
SM TE01 94430 YELLOW	4,3	7,2	21,4
SM TE01 94431 YELLOW	4,3	9,5	25,5
SM TE01 94530 YELLOW	5,3	9,5	25,2
SM TE01 94640 YELLOW	6,4	12,0	31,2
SM TE01 94840 YELLOW	8,4	15,0	33,7
SM TE01 94100 YELLOW	10,5	15,0	33,7
SM TE01 94130 YELLOW	13,0	19,2	38,1

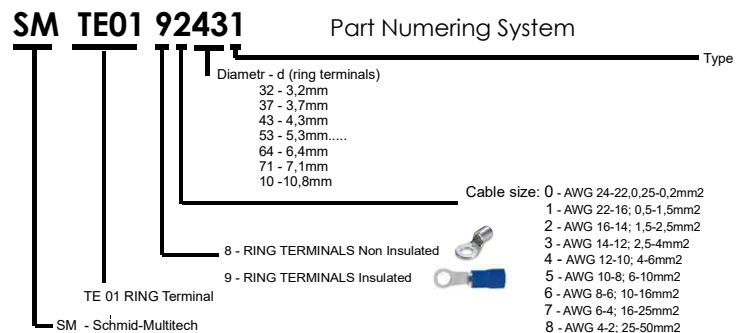
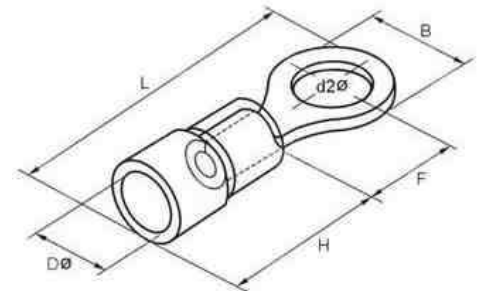

Terminals - Male



We are connecting the word....

Male Terminal 2,8mm

SM TE02 1XXXX

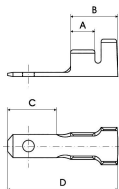

Part.No.	Tab	A	B	C	D	AWG
SM TE02 10280; AWG 24-22, Cu Zn	2,8x0,5	2,7	5,6	5,8	13,2	24-22
SM TE02 10281; AWG 24-22, Cu Zn gal Sn	2,8x0,5	2,7	5,6	5,8	13,2	24-22

Male Terminal 4,8mm

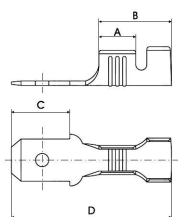

Part.No.	Tab	A	B	C	D	AWG
SM TE02 10480; AWG 24-22,Cu Zn	4,8x0,5	4,2	8,3	6,6	18,2	24-22
SM TE02 10481; AWG 24-22,Cu Zn gal Sn	4,8x0,5	4,2	8,3	6,6	18,2	24-22
SM TE02 10482; AWG 24-22,Cu Zn	4,8x0,8	4,2	8,3	6,6	18,2	24-22
SM TE02 10483; AWG 24-22,Cu Zn gal Sn	4,8x0,8	4,2	8,3	6,6	18,2	24-22

Male Terminal 6,3mm

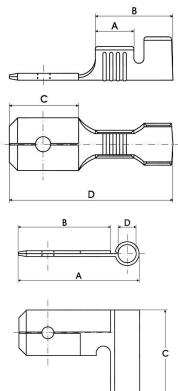

Part.No.	Tab	A	B	C	D	AWG
SM TE02 12630; AWG 16-14,Cu Zn	6,3x0,8	4,6	9,3	8,2	19,6	16-14
SM TE02 12631; AWG 16-14,Cu Zn gal Sn	6,3x0,8	4,6	9,3	8,2	19,6	16-14
SM TE02 11630; AWG 22-16,Cu Zn	6,3x0,8	4,3	8,4	8,2	19,5	22-16
SM TE02 11631; AWG 22-16,Cu Zn gal Sn	6,3x0,8	4,3	8,4	8,2	19,5	22-16
SM TE02 12632; AWG 22-16,Cu Zn	6,3x0,8	4,3	8,4	8,2	19,5	16-14
SM TE02 12633; AWG 22-16,Cu Zn gal Sn	6,3x0,8	4,3	8,4	8,2	19,5	16-14
SM TE02 14630; AWG 14-12; Steel gal Cu+Sn	6,3x0,8	5,9		8,0	18,0	14-12
SM TE02 11633; AWG 14-12; R/A Cu Zn gal Al	6,3x0,8	16,1	12,0	12,0	2,5	

Male Terminal 2,8mm for Multiple Connections

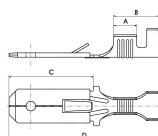

Part.No.	Tab	A	B	C	D	AWG
SM TE02 10285; AWG 24-22, Cu Zn	2,8x0,5	3,3	5,3	13,1	22,5	24-22
SM TE02 10286; AWG 24-22, Cu Zn gal Sn	2,8x0,5	3,3	5,9	13,1	22,5	24-22

Male Terminal 6,3mm for Multiple Connections

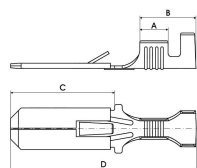

Part.No.	Tab	A	B	C	D	AWG
SM TE02 10635; AWG 24-22,Cu Zn	6,3x0,8	4,6	8,2	15,8	28	24-22
SM TE02 10636; AWG 24-22,Cu Zn gal Sn	6,3x0,8	4,6	8,2	15,8	28	24-22
SM TE02 11635; AWG 22-16,Cu Zn	6,3x0,8	4,3	8,5	15,8	28	22-16
SM TE02 11636; AWG 22-16,Cu Zn gal Sn	6,3x0,8	4,3	8,5	15,8	28	22-16
SM TE02 12635; AWG 22-16,Cu Zn	6,3x0,8	4,3	8,5	15,8	28	22-16
SM TE02 12636; AWG 22-16,Cu Zn gal Sn	6,3x0,8	4,3	8,5	15,8	28	22-16



Terminals - Female



We are connecting the word....

Female Terminals 2,80mm

SM TE02 2XXXX

Part.No.	Dimensions	A	B	C	D	E
SM TE02 20280; AWG 24-22, Cu Zn	2,8x0,5	2,7	5,1	6,5	5,7	14
SM TE02 20281; AWG 24-22, Cu Zn gal Sn	2,8x0,5	2,7	5,1	6,5	5,7	14
SM TE02 20282; AWG 24-22, Cu Zn	2,8x0,8	2,7	5,1	6,5	5,7	14
SM TE02 20283; AWG 24-22, Cu Zn gal Sn	2,8x0,8	2,7	5,1	6,5	5,7	14
SM TE02 20284; AWG 24-22, Cu Zn	2,8x0,5	2,7	5,1	6,5	3,7	14
SM TE02 20285; AWG 24-22, Cu Zn gal Sn	2,8x0,5	2,7	5,1	6,5	3,7	14
SM TE02 20286; AWG 24-22, Cu Zn	2,8x0,8	2,7	5,1	6,5	3,7	14
SM TE02 20287; AWG 24-22, Cu Zn gal Sn	2,8x0,8	2,7	5,1	6,5	3,7	14

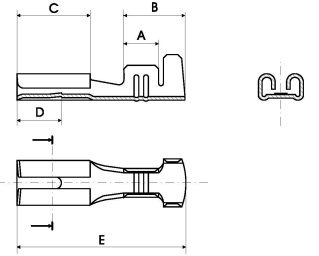

PACKING: Reel - Standard - Bag - on request

Female Terminals 4,30mm

Part.No.	Dimensions	A	B	C	D	E
SM TE02 20480; AWG 24-22, Cu Zn	4,8x0,5	3,2	6,4	6,4	3,6	15,2
SM TE02 20481; AWG 24-22, Cu Zn gal Sn	4,8x0,5	3,2	6,4	6,4	3,6	15,2
SM TE02 20482; AWG 24-22, Cu Zn	4,8x0,8	3,2	6,4	6,4	3,6	15,2
SM TE02 20483; AWG 24-22, Cu Zn gal Sn	4,8x0,8	3,2	6,4	6,4	3,6	15,2
SM TE02 21480; AWG 22-16, Cu Zn	4,8x0,5	3,2	6,4	6,4	3,6	15,2
SM TE02 21481; AWG 22-16, Cu Zn gal Sn	4,8x0,5	3,2	6,4	6,4	3,6	15,2
SM TE02 21482; AWG 22-16, Cu Zn	4,8x0,8	3,2	6,4	6,4	3,6	15,2
SM TE02 21483; AWG 22-16, Cu Zn gal Sn	4,8x0,8	3,2	6,4	6,4	3,6	15,2

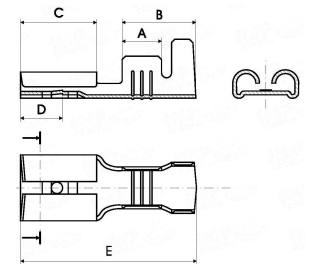

PACKING: Reel - Standard - Bag - on request

Female Terminals 6,30mm

Part.No.	Dimensions	A	B	C	D	E
SM TE02 21630; AWG 22-16, Cu Zn	6,3x0,8	4,5	8	7,7	4	19,3
SM TE02 21631; AWG 22-16, Cu Zn gal Sn	6,3x0,8	4,5	8	7,7	4	19,3
SM TE02 22630; AWG 16-14, Cu Zn	6,3x0,8	5,1	9,1	7,7	4	19,3
SM TE02 22631; AWG 16-14, Cu Zn gal Sn	6,3x0,8	5,1	9,1	7,7	4	19,3
SM TE02 24630; AWG 12-10, Cu Zn	6,3x0,8	5	9	7,7	4	19,3
SM TE02 24631; AWG 12-10, Cu Zn gal Sn	6,3x0,8	5	9	7,7	4	19,3

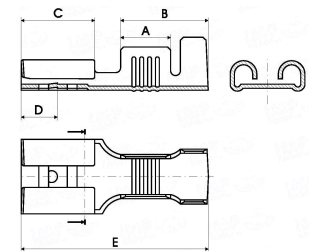

PACKING: Reel - Standard - Bag - on request

Female Terminals 9,30mm

Part.No.	Dimensions	A	B	C	D	E
SM TE02 24950; AWG 12-10, Cu Zn	9,5x0,8mm	5	10	12	7,6	27,3
SM TE02 24951; AWG 12-10, Cu Zn gal Sn	9,5x0,8mm	5	10	12	7,6	27,3

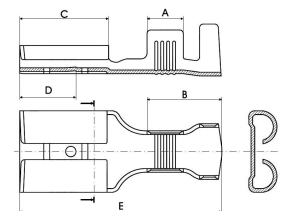

PACKING: Reel - Standard - Bag - on request

Terminals - Female



Female Terminals For Multiple Connections 6,30mm

SM TE02 2XXXX

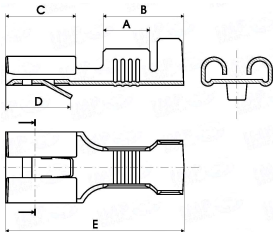

Part.No.	Dimensions	A	B	C	D	E
SM TE02 21632; AWG 22-16, Cu Zn	6,3x0,8	4	8	7,7	7	19,3
SM TE02 21633; AWG 22-16, Cu Zn	6,3x0,8	4	8	7,7	7	19,3
SM TE02 22632; AWG 16-14, Cu Zn	6,3x0,8	4	8	7,7	7	19,3
SM TE02 22633; AWG 22-16, Cu Zn	6,3x0,8	4	8	7,7	7	19,3

Female Terminals Low Insertion 2,80mm; 4,30mm and 6,30mm

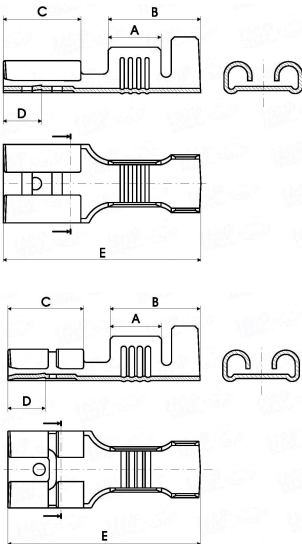

Part.No.	Dimensions	A	B	C	D	E
SM TE02 21285; LI; AWG 22-16, Cu Zn	2,8x2,8	2,7	5,1	6,4	3,7	14
SM TE02 21286; LI; AWG 22-16, Cu Zn gal Sn	2,8x2,8	2,7	5,1	6,4	3,7	14
SM TE02 21287; LI; AWG 22-16, Cu Zn	2,8x2,8	2,7	5,1	6,4	5,7	14
SM TE02 21288; LI; AWG 22-16, Cu Zn gal Sn	2,8x2,8	2,7	5,1	6,4	5,7	14
SM TE02 21485; LI; AWG 22-16, Cu Zn	4,8x0,5	3,2	6,4	6,4	3,6	15,2
SM TE02 21486; LI; AWG 22-16, Cu Zn gal Sn	4,8x0,5	3,2	6,4	6,4	3,6	15,2
SM TE02 21487; LI; AWG 22-16, Cu Zn	4,8x0,8	3,2	6,4	6,4	3,6	15,2
SM TE02 21488; LI; AWG 22-16, Cu Zn gal Sn	4,8x0,8	3,2	6,4	6,4	3,6	15,2
SM TE02 22485; LI; AWG 16-14, Cu Zn	4,8x0,5	3,2	6,4	6,4	3,6	15,2
SM TE02 22486; LI; AWG 16-14, Cu Zn gal Sn	4,8x0,5	3,2	6,4	6,4	3,6	15,2
SM TE02 22487; LI; AWG 16-14, Cu Zn	4,8x0,8	3,2	6,4	6,4	3,6	15,2
SM TE02 22488; LI; AWG 16-14, Cu Zn gal Sn	4,8x0,8	3,2	6,4	6,4	3,6	15,2
SM TE02 21635; LI; AWG 22-16, Cu Zn	6,3x0,8	4,5	8,3	7,7	4	19,3
SM TE02 21636; LI; AWG 22-16, Cu Zn gal Sn	6,3x0,8	4,5	8,3	7,7	4	19,3
SM TE02 22635; LI; AWG 22-16, Cu Zn	6,3x0,8	5	9,2	7,7	4	19,3
SM TE02 22636; LI; AWG 22-16, Cu Zn gal Sn	6,3x0,8	5	9,2	7,7	4	19,3

PACKING: Reel - Standard -
Bag - on request

Female Terminals Special 6,3mm (Weld, with Tab, Flag, Security)

SM TE02 29630; to Weld; Steel
SM TE02 29631; to Weld; Steel

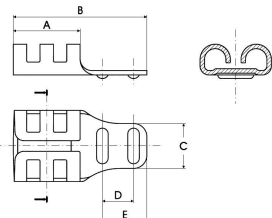

SM TE02 29635; Tab; Cu Zn
SM TE02 29636; Tab; Cu Zn Sn

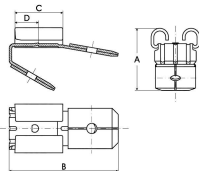

SM TE02 21637; Tab; Cabel
SM TE02 21638; Tab; Cabel Sn

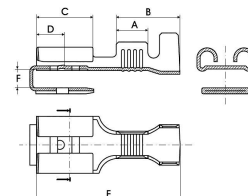

SM TE02 22637; Flag; Cu Zn
SM TE02 22638; Flag; Cu Zn Sn

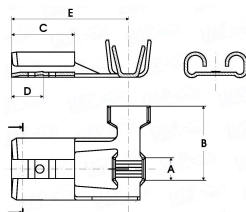

SM TE02 21639; Sec. AWG 22-16
SM TE02 22639; Sec. AWG 16-14

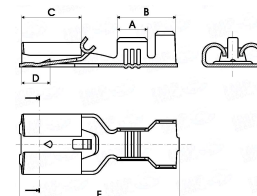

PACKING: Reel - Standard -
Bag - on request

Male and Female Insulated

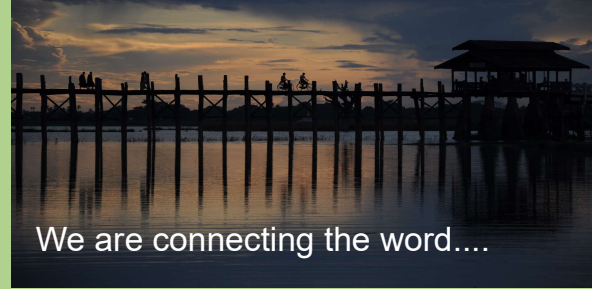

We are connecting the word....

Male Insulated Terminals

SM TE02 3XXXX

Cable size 0.5~1.5mm ² (A.W.G. 22~16) Max current : I _{max} =10A Material: copper						
Part.No.	Tab	B	d	D	L	H
SM TE02 31280; RED	2,8x0,5	2,8	1,7	4,3	17,7	10
SM TE02 31281; RED	2,8x0,8	2,8	1,7	4,3	17,7	10
SM TE02 31480; RED	4,8x0,5	4,75	1,7	4,3	20	10
SM TE02 31481; RED	4,8x0,8	4,75	1,7	4,3	20	10
SM TE02 31630; RED	6,3x0,8	6,35	1,7	4,3	21	10
Cable size 1.5~2.5mm ² (A.W.G. 16~14) Max current : I _{max} =15A Material: copper						
Part.No.	Tab	B	d	D	L	H
SM TE02 32480; BLUE	4,8x0,5	4,75	2,3	4,3	20	10
SM TE02 32481; BLUE	4,8x0,8	4,75	2,3	4,3	20	10
SM TE02 32630; BLUE	6,3x0,8	6,35	2,3	4,3	21	10
Cable size 4~6mm ² (A.W.G. 12~10) Max current : I _{max} =24A Material: copper						
Part.No.	Tab	B	d	D	L	H
SM TE02 34630; YELLOW	6,3x0,8	6,35	3,4	5,7	25	13

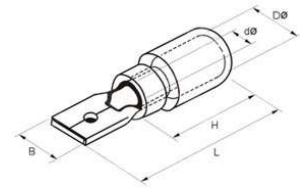

PACKING: Reel - Standard - Bag - on request

Female Insulated Terminals

SM TE02 4XXXX

Cable size 0.5~1.5mm ² (A.W.G. 22~16) Max current : I _{max} =10A Material: copper						
Part.No.	TAB	B	D	d	L	H
SM TE 02 41280 RED	2,8x0,5	3,8	3,8	1,7	19	10
SM TE 02 41281 RED	2,8x0,8	3,8	3,8	1,7	19	10
SM TE 02 41480 RED	4,8x0,5	5,6	3,8	1,7	19	10
SM TE 02 41481 RED	4,8x0,8	5,6	3,8	1,7	19	10
SM TE 02 41500 RED	5,2x0,5	6,5	3,8	1,7	20	10
SM TE 02 41630 RED	6,3x0,8	7,4	3,8	1,7	21	10
Cable size 1.5~2.5mm ² (A.W.G. 16~14) Max current : I _{max} =15A Material: copper						
Part.No.	TAB	B	D	d	L	H
SM TE 02 42280 BLUE	2,8x0,5	3,8	4,3	2,3	19	10
SM TE 02 42281 BLUE	2,8x0,8	3,8	4,3	2,3	19	10
SM TE 02 42480 BLUE	4,8x0,5	5,6	4,3	2,3	19	10
SM TE 02 42481 BLUE	4,8x0,8	5,6	4,3	2,3	19	10
SM TE 02 42500 BLUE	5,2x0,5	6,5	4,3	2,3	20	10
SM TE 02 42630 BLUE	6,3x0,8	7,4	4,3	2,3	21	10
SM TE 02 42800 BLUE	8x0,8	9	4,3	2,3	23	10
Cable size 4~6mm ² (A.W.G. 12~10) Max current : I _{max} =24A Material: copper						
Part.No.	TAB	B	D	d	L	H
SM TE 02 44630 YELLOW	6,3x0,8	7,4	5,7	3,4	25	13
SM TE 02 44940 YELLOW	9,4x1,2	10,9	5,7	3,4	29,6	13

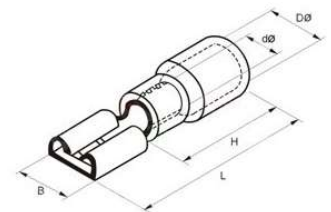

PACKING: Reel - Standard - Bag - on request

Piggy and Fully- Insulated

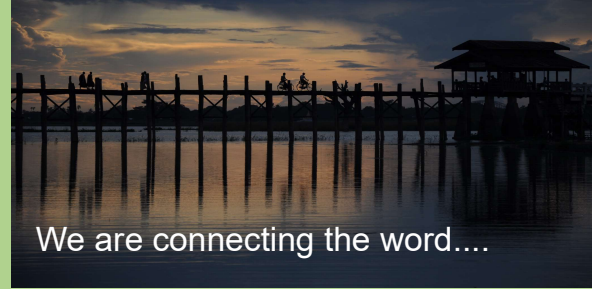

We are connecting the word....

Female and Male Fully-Insulated Terminals 6,30mm

SM TE02 5XXXX



Max current: 10A		Material: copper							Insulating: Nylon			
Part.No.	TAB	Dimension (mm)								diagram	cable size	color
		W	F	L	B	D	C	T				
SM TE02 51630 Female RED	6,35x0,8	6.6	7.3	22.0	11.0	4.0	1.7	0.4	1	22~16	red	
SM TE02 51631 Male RED	6,35x0,8	6.35	7.7	23.0					2			A.W.G

Max current: 15A		Material: copper							Insulating: Nylon			
Part.No.	TAB	Dimension (mm)								diagram	cable size	color
		W	F	L	B	D	C	T				
SM TE02 52630 Female BLUE	6,35x0,8	6.6	7.3	22.0	11.0	4.5	3.4	0.4	1	16~14	blue	
SM TE02 52631 Male BLUE	6,35x0,8	6.35	7.7	24.0					2			A.W.G

Max current: 24A		Material: copper							Insulating: Nylon			
Part.No.	TAB	Dimension (mm)								diagram	cable size	color
		W	F	L	B	D	C	T				
SM TE02 54630 Female YELLOW	6,35x0,8	6.6	7.3	24.0	13.0	6.3	3.4	0.4	1	12~10	yellow	
SM TE02 54631 Male YELLOW	6,35x0,8	6.35	7.7	25.0					2			A.W.G

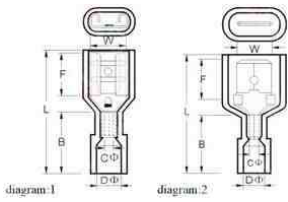

Fully Piggy Back Terminals 6,30mm

SM TE02 5XXX5

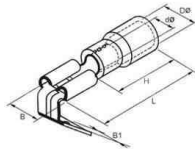

Part.No.	TAB	B	B1	H	D	d	L
SM TE02 51635 Piggyback ROT	6,35x0,8	7,4	6,4	10	3,8	1,7	22
SM TE02 52635 Piggyback BLUE	6,35x0,8	7,4	6,4	10	3,8	1,7	22
SM TE02 54635 Piggyback YELLOW	6,35x0,8	7,4	6,4	10	3,8	1,7	22

Fork Naked Terminals

SM TE02 6XXXX



Max current: 19A		Material: purple copper						Thickness: 0.75mm	
Part.No.	Screw size d2 (mm)	Dimension (mm)						cable size	
		B	F	L	E	D	d		
SM TE02 61370, AWG 22-16	3.7	6.4	6.4	16.0	4.8	3.4	1.7	22-16 AWG 0.5- 1.5mm ²	
SM TE02 61430, AWG 22-16	4.3	7.2							
SM TE02 61431, AWG 22-16	4.3	8.1							
SM TE02 61530, AWG 22-16	5.3	8.1							
SM TE02 61531, AWG 22-16	5.3	9.5							

Max current: I _{max} = 27A		Material: purple copper						Thickness: 0.8mm	
Part.No.	Screw size d2 (mm)	Dimension (mm)						cable size	
		B	F	L	E	D	d		
SM TE02 62370, AWG 16-14	3.7	6.0	6.4	16.0	4.8	4.1	2.3	16-14 AWG 1.5- 2,5mm ²	
SM TE02 62430, AWG 16-14	4.3	7.2							
SM TE02 62431, AWG 16-14	4.3	8.1							
SM TE02 62530, AWG 16-14	5.3	8.1							
SM TE02 62531, AWG 16-14	5.3	9.5							

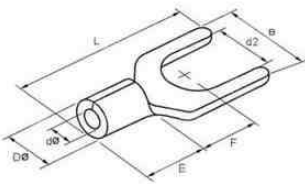

Terminals - Fork

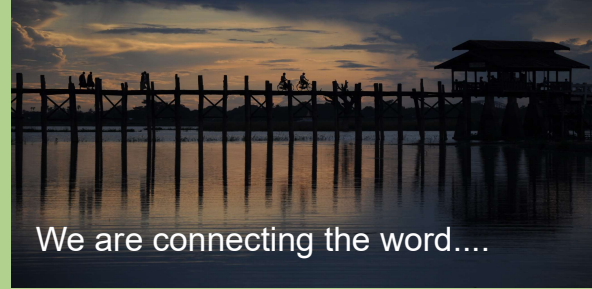

We are connecting the word....

Fork Naked Terminals

SM TE02 6xxx0

Max current: I _{max} = 27A		Material: purple copper		Thickness: 0.8mm				
Item No	Screw size d2 (mm)	Dimension (mm)						cable sizemm
		B	F	L	E	D	d	
SM TE02 63370, AWG 12-10	3,7	8,3	7,5	19,5	6,0	5,6	3,4	12-10 AWG 4- 6mm
SM TE02 63430, AWG 12-10	4,3							
SM TE02 63530, AWG 12-10	5,3	9						
SM TE02 63640, AWG 12-10	6,4	12	12	24,5				

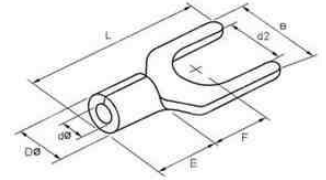

Fork Insulated Terminals

SM TE02 6xxx5

Cable size: 0.5~1.5mm ² (AWG 22~16) Current: I _{max} =19A Material: copper								
Part.No,	Screw Size	d2	B	L	F	H	D	Color
SM TE 02 61375 RED	#6	3,7	7,5	19	5,1	10	4,3	RED
SM TE 02 61435 RED	#8	4,3						
SM TE 02 61535 RED	#10	5,3						



Cable size: 1,5~2,5mm ² (AWG 16-14) Current: I _{max} =27A Material: copper								
Part.No,	Screw Size	d2	B	L	F	H	D	Color
SM TE 02 62375 BLUE	#6	3,7	7,5	19	5,1	10	4,9	BLUE
SM TE 02 62435 BLUE	#8	4,3						
SM TE 02 62535 BLUE	#10	5,3						

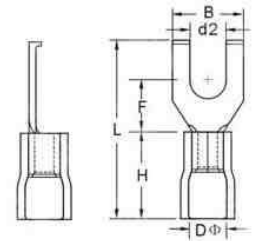

Cable size: 4~6mm ² (AWG 12~10) Current: I _{max} =48A Material: copper								
Part.No,	Screw Size	d2	B	L	F	H	D	Color
SM TE 02 64375 YELLOW	#6	3,7	8,5	25,5	7,5	13	6,7	YELLOW
SM TE 02 64435 YELLOW	#8	4,3						
SM TE 02 64535 YELLOW	#10	5,3						

Insulated Receptacle Disconnects

SM TE02 7xxx0

Cable size: 0.5~1.5mm ² (AWG 22~16) Current: I _{max} =10A Material: copper							
Part.No.	Thickness	d	B	D	F	L	COLOR
SM TE02 71040 F RED	0,4	4,0	6,3	1,7	13,0	24,5	RED
Cable size: 1.5~2.5mm ² (AWG 16~14) Current: I _{max} =15A Material: copper							
Part.No.	Thickness	d	B	D	F	L	COLOR
SM TE02 72040 F BLUE	0,4	4,0	6,3	2,3	14,0	24,5	BLUE
SM TE02 72050 F BLUE	0,4	5,0	7,0	2,3	14,0	25,5	BLUE
Cable size: 4~6mm ² (AWG 12~10) Current: I _{max} =24A Material: copper							
Part.No.	Thickness	d	B	D	F	L	COLOR
SM TE02 74050 F YELLOW	0,4	5,0	7,0	3,4	14,0	29,5	YELLOW

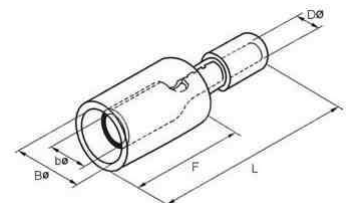

Terminals - Conjunction

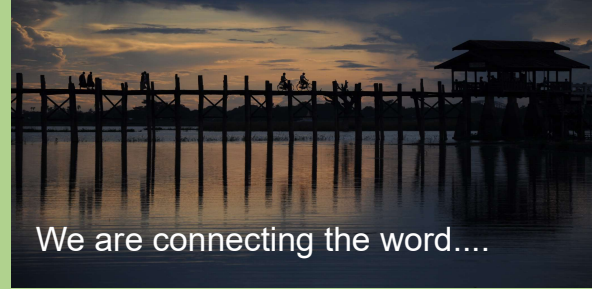

We are connecting the word....

Insulated Male Disconnects

SM TE02 7xxx2

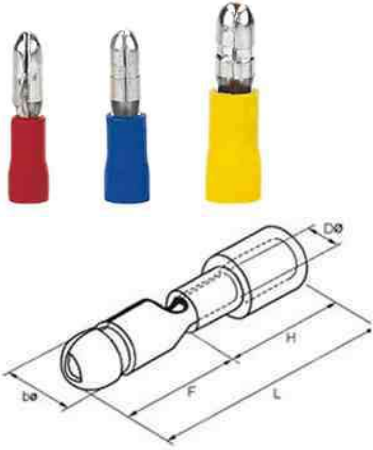

Cable size: 0.5~1.5mm ² (AWG 22~16) Current: I _{max} =10A Material: copper							
Part.No.	Thickenss	b	F	D	H	L	COLOR
SM TE02 71042 M RED	0,4	4,0	11,0	1,7	10,0	21,0	RED
Cable size: 1.5~2.5mm ² (AWG 16~14) Current: I _{max} =15A Material: copper							
Part.No.	Thickenss	b	F	D	H	L	COLOR
SM TE02 72042 M BLUE	0,4	4,0	11,0	2,3	10,0	21,0	BLUE
SM TE02 72052 M BLUE	0,4	5,0	11,0	2,3	10,0	21,0	BLUE
Cable size: 4~6mm ² (AWG 12~10) Current: I _{max} =24A Material: copper							
Part.No.	Thickenss	b	F	D	H	L	COLOR
SM TE02 74052 M YELLOW	0,4	5,0	12,0	3,4	13,0	25,0	YELLOW

Insulated conjunction

SM TE02 8xxx5...6

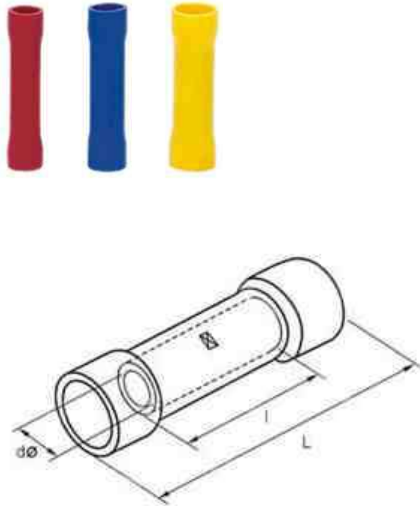

Long Full-insulating Middle Joint; Material:purple copper Insulating material : PVC							
Part.No.	AWG	mm ²	l	d	L	I _{max}	Color
SM TE02 71175 C RED	22-16	0,5-1,5	15	1,7	26	19A	RED
SM TE02 72235 C BLUE	16-14	1,5-2,5	15	2,3	26	27A	BLUE
SM TE02 74345 C YELLOW	12-10	4-6	15	3,4	26	48A	YELLOW
SM TE02 75455 C RED	#8	6-10	21	4,5	32	62A	RED
SM TE02 76585 C BLUE	#6	10-16	26	5,8	42	88A	BLUE
SM TE02 77775 C YELLOW	#4	16-25	29	7,7	50	115A	YELLOW
SM TE02 78945 C RED	#2	35-50	32	9,4	55	160A	RED
Short Full-insulating Middle Joint; Material:purple copper Insulating material : PVC							
Part.No.	AWG	mm ²	l	d	L	I _{max}	Color
SM TE02 71176 C RED	22-16	0,5-1,5	8	1,7	16,0	19A	RED
SM TE02 72236 C BLUE	16-14	1,5-2,5	8	2,3	16,0	27A	BLUE
SM TE02 74346 C BLUE	12-10	4-6	8	3,4	20,5	48A	YELLOW

Non - Insulated Conjunction

SM TE02 7xxx8



Part.No.	AWG	mm ²	D	d	L
SM TE02 71337, AWG 22-16	22-16	0,5-1,5	3,3	1,7	15,0
SM TE02 72407, AWG 16-14	16-14	1,5-2,5	4,0	2,3	15,0
SM TE02 73507, AWG 14-12	14-12	2,5-4	5,0	3	15,0
SM TE02 74557, AWG 12-10	12-10	4-6	5,5	3,4	15,0
SM TE02 75717, AWG 10-8	#8	10	7,1	4,5	21,0
SM TE02 76907, AWG 8-6	#6	16	9,0	5,8	26,0
SM TE02 77117, AWG 6-4	#4	25	11,4	7,7	29,0
SM TE02 78137, AWG 4-2	#2	35	13,3	9,4	32,0

On Request to 300mm²

Insulated Lipped and Pin T.

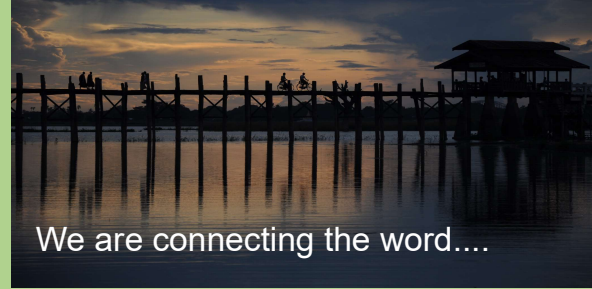

We are connecting the word....

Insulated Lipped Blade Terminals

SM TE02 8xxx0

Cable size:0.5~1.5mm ² (A.W.G.22~16) Max current:I _{max} =19A Material: copper Thickness:0.75mm							
Part.No.	B	L	F	H	D	Color	AWG
SM TE02 81100; Blade; F=10; RED	2,3	20,0	10,0	10,0	4,3	RED	22-16
SM TE02 81110; Blade; F=11; RED	3,0	21,0	11,0				
SM TE02 81140; Blade; F=14; RED	3,0	24,0	14,0				
SM TE02 81180; Blade; F=18; RED	2,2	28,0	18,0				
Cable size:1.5~2.5mm ² (A.W.G.16~14) Max current:I _{max} =27A Material: copper Thickness:0.8mm							
Part.No.	B	L	F	H	D	Color	AWG
SM TE02 82090; Blade; F=9; BLUE	2,4	19,0	9,0	10,0	4,9	BLUE	16-14
SM TE02 82140; Blade; F=14; BLUE	2,4	24,0	14,0				
SM TE02 82180; Blade; F=18; BLUE	2,2	28,0	18,0				
Cable size:4~6mm ² (A.W.G.12~10) Max current: max=48A Material: copper Thickness:1.0mm							
Part.No.	B	L	F	H	D	Color	AWG
SM TE02 84100; Blade; F=10; YELLOW	2,8	22,5	10,0	13,0	5,6	YELLOW	12-10
SM TE02 84140; Blade; F=14; YELLOW	4,5	26,5	14,0				
SM TE02 84180; Blade; F=18; YELLOW	4,5	30,5	18,0				

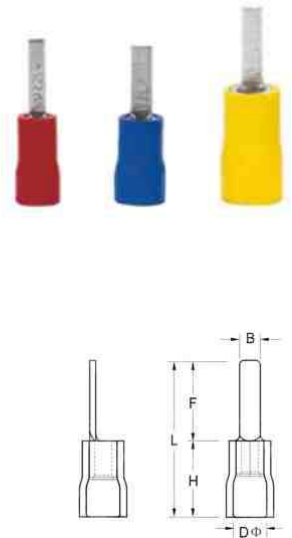

Insulated Pin Terminals

SM TE02 8xxx5

Cable size:0.5~1.5mm ² (A.W.G.22~16) Current:I _{max} =19A Material: copper Thickness:0.75mm						
Part.No.	F	L	H	D	Color	AWG
SM TE02 81195; Pin; L=19; RED	1,9	19,0	10,0	4,3	RED	22-16
SM TE02 81195; Pin; L=20; RED		20,0				
SM TE02 81205; Pin; L=33; RED		22,0				
SM TE02 81235; Pin; L=23; RED		23,0				
SM TE02 81285; Pin; L=28; RED		28,0				
Cable size:1.5~2.5mm ² (A.W.G.16~14) Max current:I _{max} =27A Material: copper Thickness:0.8mm						
Part.No.	F	L	H	D	Color	AWG
SM TE02 82195; Pin; L=19; BLUE	1,9	19,0	10,0	4,9	BLUE	16-14
SM TE02 82205; Pin; L=20; BLUE		20,0				
SM TE02 82205; Pin; L=22; BLUE		22,0				
SM TE02 82235; Pin; L=23; BLUE		23,0				
SM TE02 82285; Pin; L=28; BLUE		28,0				
Cable size:2.5~4mm ² (A.W.G.14~12) Max current:I _{max} =36A Material: copper Thickness:1.0mm						
Part.No.	F	L	H	D	Color	AWG
SM TE02 83205; Pin; L=20; BLACK	2,8	20,0	13,0	6,2	BLACK	14-12
SM TE02 83255; Pin; L=25,5; BLACK		25,5				
Cable size:4~6mm ² (A.W.G.12~10) Max current:I _{max} =48A Material: copper Thickness:1.0mm						
Part.No.	F	L	H	D	Color	AWG
SM TE02 84255; Pin; L=25,5; YELLOW	2,8	25,5	13,0	6,7	YELLOW	12-10

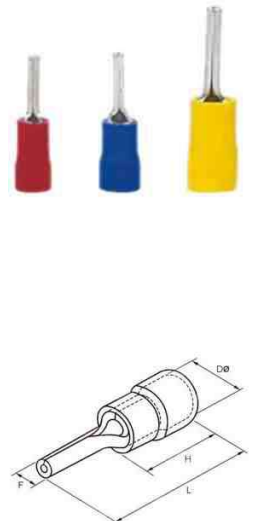

Insulated Cord End Terminals

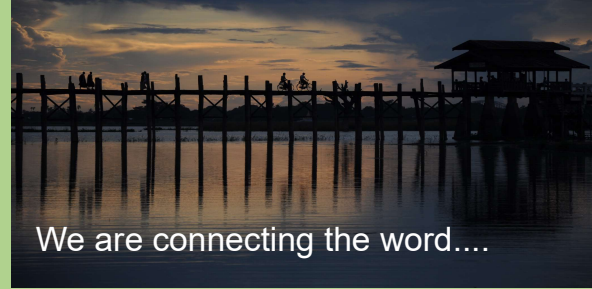

We are connecting the word....

Insulated Cord End Terminals

SM TE02 9xxxx

Part.No.	F	L	W	D	C	AWG	Cable Size	Color
SM TE02 90060; F=6mm; AWG22	6,0	12,0	2,5	1,3	1,0	22	0,50	orange / white
SM TE02 90080; F=8mm; AWG22	8,0	14,0						
SM TE02 90100; F=10mm; AWG22	10,0	16,0						
SM TE02 90120; F=12mm; AWG22	12,0	18,0						
SM TE02 91060; F=6mm; AWG20	6,0	12,4	2,8	1,5	1,2	20	0,75	white / blue
SM TE02 91080; F=8mm; AWG20	8,0	14,6						
SM TE02 91100; F=10mm; AWG20	10,0	16,4						
SM TE02 91120; F=12mm; AWG20	12,0	18,4						
SM TE02 91061; F=6mm; AWG18	6,0	12,4	3,0	1,7	1,4	18	1,00	yellow / red
SM TE02 91081; F=8mm; AWG18	8,0	14,6						
SM TE02 91101; F=10mm; AWG18	8,0	16,4						
SM TE02 91121; F=12mm; AWG18	12,0	18,4						
SM TE02 92080; F=8mm; AWG16	8,0	14,6	3,5	2,0	1,7	16	1,50	red / black
SM TE02 92100; F=10mm; AWG16	10,0	16,4						
SM TE02 92120; F=12mm; AWG16	16,0	18,4						
SM TE02 92180; F=18mm; AWG16	18,0	24,4						
SM TE02 93080; F=8mm; AWG14	8,0	15,2	4,1	2,6	2,3	14	2,50	blue / grey
SM TE02 93100; F=10mm; AWG14	10,0	17,2						
SM TE02 93120; F=12mm; AWG14	12,0	19,2						
SM TE02 93180; F=18mm; AWG14	18,0	25,2						
SM TE02 94090; F=9mm; AWG12	9,0	16,5	4,4	3,2	2,8	12	4,00	grey / orange
SM TE02 94120; F=12mm; AWG12	12,0	19,5						
SM TE02 94180; F=18mm; AWG12	19,0	25,5						
SM TE02 95100; F=10mm; AWG10	10,0	18,0	6,3	3,9	3,5	10	6,00	black / green
SM TE02 95120; F=12mm; AWG10	12,0	20,0						
SM TE02 95180; F=18mm; AWG10	18,0	26,0						
SM TE02 96120; F=12mm; AWG7	12,0	21,5	7,6	4,9	4,5	7	10,00	milk / brown
SM TE02 96180; F=18mm; AWG7	18,0	27,5						
SM TE02 97120; F=12mm; AWG5	12,0	22,2	8,8	6,2	5,8	5	16,00	green / milk
SM TE02 97180; F=18mm; AWG5	18,0	28,2						
SM TE02 98160; F=16mm; AWG4	16,0	29,0	11,2	7,9	7,5	4	25,00	brown / black
SM TE02 98220; F=22mm; AWG4	22,0	35,0						
SM TE02 99160; F=16mm; AWG2	16,0	30,0	12,7	8,7	8,3	2	35,00	grey
SM TE02 99250; F=25mm; AWG2	25,0	39,0						
SM TE02 99161; F=20mm; AWG1	20,0	36,0	15,3	10,9	10,3	1	50,00	olive
SM TE02 99251; F=25mm; AWG1	25,0	41,0						

