

...ept



**0.8 mm SMT Board-to-Board
connector**

March 2022

Zero 8
e d i t i o n

Zero8

SMT connector with high scalability

Discover the 5 superpowers of the Zero8 connector family!



**SUPERPOWER
EFFICIENCY**



**SUPERPOWER
SIGNAL PROTECTION**

Developers can count on the Zero8 super powers to make work easier for them:

- Efficiency through exceptional scalability and variability,
- Signal protection through effective EM-shielding,
- Contact reliability through innovative ScaleX contact system with high tolerance,
- Robustness through board lock and compact anti-twist design with contact protection,
- Speed of up to 16 Gbps through HighSpeed-optimized contact design



SUPERPOWER
CONTACT RELIABILITY



SUPERPOWER
ROBUSTNESS



SUPERPOWER
SPEED

SUPERPOWER EFFICIENCY

- Saves space thanks to 0.8 mm pitch
- Variable number of contacts from 12 to 80
- Vailable with or without shielding
- Stack heights from 6 to 21 mm
- Angled types for 90° and 180° applications

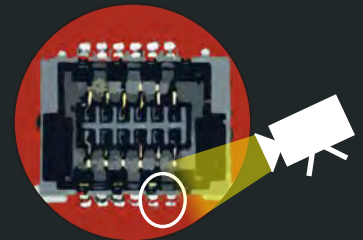
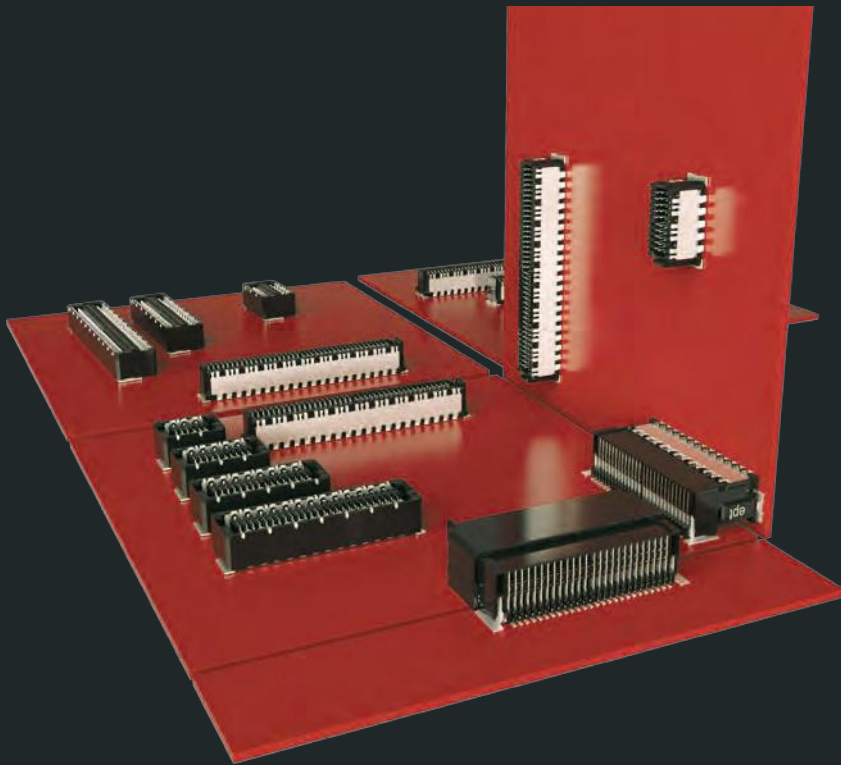

AOI control

optimized contact design for automated testing after soldering

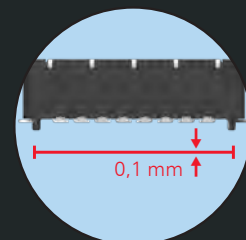

coplanarity

soldering under controlled process conditions

A hero with many faces: He is fast. He gets you to your destination. But above all, he is versatile. With the Zero8, you develop your solutions with maximum efficiency. Its features ensure that you get to your goal faster and benefit from an enormous range of variants. Even angled designs for 90° and 180° applications are available.



SUPERPOWER SIGNAL PROTECTION

- Newly developed EMC shielding concept
- Optimal discharge of interference currents
- Coupling inductance of max. 10 picohenry (pH)
- Without shielding - as an alternative

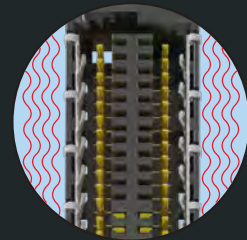
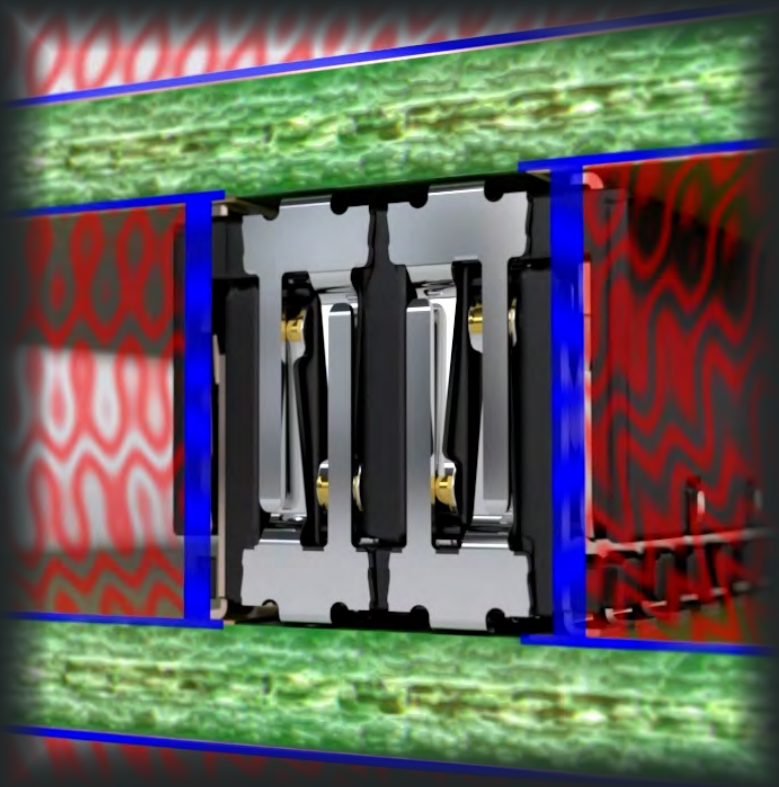

EMC shielding

double sided shielding ensures a high electromagnetic compatibility for optimal signal integrity in the industrial environment

The Zero8 connector won't let you down: with its newly developed, two-sided shielding concept, it ensures interference-free high-speed transmission in industrial environments. The shielding material used is especially suitable for components with high electromagnetic compatibility requirements and guarantees a coupling inductance of max. 10 pH for the connector.

SUPERPOWER CONTACT RELIABILITY

- Innovative ScaleX contact system
- Two contact areas per pin
- Resistance to shock and vibration
- Absolutely secure mating
- Able to withstand at least 500 mating cycles

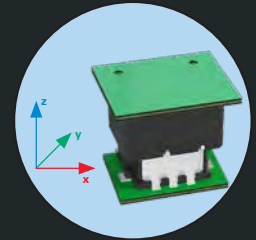

tolerance compensation
high reliability through
tolerance compensation

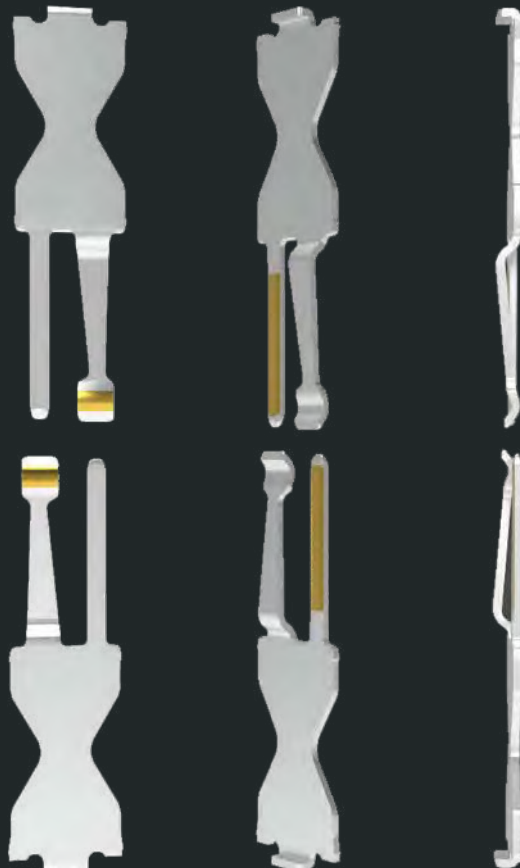

smooth contact surface
the contact on the homogenous
rolled side with high-end
surface allows for up to
500 mating cycles



**double sided
contact system**
for a secure connection in
industrial environments
(shock, vibration, thermal cycles,
corrosive gas)

Delivers what it promises: Thanks to its robust and double-sided ScaleX technology, the Zero8 always ensures a reliable connection. It defies typically harsh conditions in industrial applications. And it does so even under extreme environmental and mechanical stress such as shock and vibration.



SUPERPOWER ROBUSTNESS

- All contacts are protected
- Anti-twist protection during mating
- Mechanical relief provided by two board locks
- Offset compensation of up to 0.7 mm during installation
- High tolerance compensation during operation

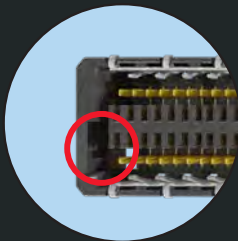

twist guard

for correct connection of plug and socket



positioning pins

optimal processing through precise positioning



protected contacts

optimized contact and casing geometry reduce damage to contacts



boardlock

absorbs mechanical stress and ensures a reliable connection to the PCB



solder meniscus

guarantees a robust surface mount connection

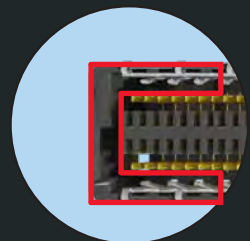

insertion chamfer

for compensation of misalignment and angular inclination

Another ace up its sleeve: With its clever anti-twist protection during mating, a tolerance compensation of ± 0.4 mm when mated and an offset compensation of up to 0.7 mm during installation, the Zero8 is unbreakable. In addition to all these top features, its incredible robustness makes it a very reliable companion - even under the most adverse environmental conditions.



SUPERPOWER SPEED

- Suitable for PCIe 4.0 and Industrial Ethernet
- RF signal transmission of 16 Gbps +
- Additional signal protection through shielding
- SI models available

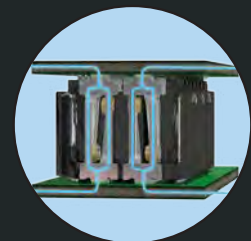
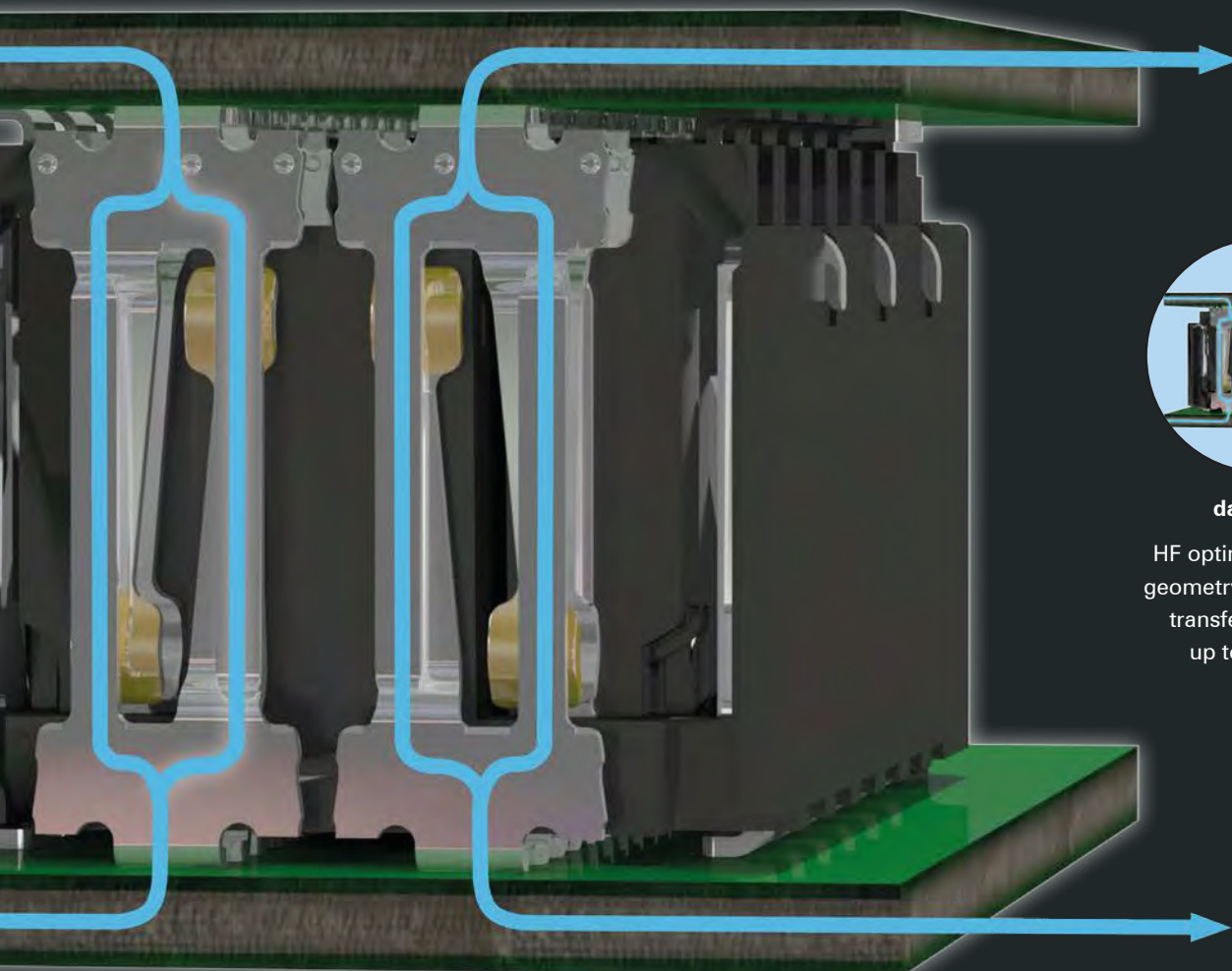

data flow

HF optimized contact geometry ensures data transfer speeds of up to 16 Gbps

Fast as lightning: High-speed simulations with the Zero8 connector system feature excellent signal integrity at 16 Gbps and are therefore predestined for the PCIe 4.0 and Industrial Ethernet transmission standards. We are happy to provide the S-parameters for your application simulations.



Zero8 – 0.8 mm SMT for Board-to-Board Applications

Scalable & Robust

The product group Zero8 with ScaleX technology offers a high level of design, stacking and pin count scalability. This connector series is available with double sided shielding or as an unshielded version.

The robust ScaleX connector technology ensures a secure contact during mechanical stress (vibration, shock) and compensates for unit tolerances in all directions (x,y,z). The connector's sophisticated geometry protects its contacts from faulty handling.



ScaleX - Double sided, robust contact technology in a versatile and scalable connector system.

For more information please visit www.ept.de/Zero8

Key Features:

- up to 16 Gbps
- 12 to 80 pins
- 1.4 A operational current
- 500 mating cycles
- reliable contact
- optimized contact damage prevention
- packed in Tape & Reel

Applications:

- board-to-board (mezzanine) from 6 - 21 mm
- parallel and perpendicular connection
- shielded and unshielded version

Termination

SMT

Application

HighSpeed



High Density



EMC



Rugged



Variability

Zero8 – Product Overview

Type of Zero8 connector			Height	Number of pins	Mating configurations			Page
					 Parallel	 Horizontal	 Perpendicular	
	Plug Socket low-profile	shielded	1.15 mm 4.85 mm	12 ... 80	✓		✓	22, 23
	Plug Socket mid-profile	shielded	2.65 mm 7.85 mm	12 ... 80	✓		✓	24, 25
	Plug Socket (coming soon) high-profile	shielded	7.15 mm 10.85 mm	12 ... 80	✓		✓	26, 27
	Plug X-high	shielded	8.65 mm	12 ... 80	✓		✓	28
	Plug Socket angled	shielded		12 ... 80		✓	✓	30, 31
	Plug Socket low-profile	unshielded	1.15 mm 4.85 mm	12 ... 80	✓		✓	32, 33
	Plug Socket mid-profile	unshielded	2.65 mm 7.85 mm	12 ... 80	✓		✓	34, 35
	Plug Socket (coming soon) high-profile	unshielded	7.15 mm 10.85 mm	12 ... 80	✓		✓	36, 37
	Plug X-high	unshielded	8.65 mm	12 ... 80	✓		✓	38
	Plug Socket angled	unshielded		12 ... 80		✓	✓	40, 41

PCB Distances Board-to-Board

Board-to-Board distances of 6.00 to 21.00 mm can be achieved using Zero8 connections – whether you decide on a shielded or unshielded version.



6.00 - 21.00 mm

		plug			
socket		plug low	plug mid	plug high	plug x-high
	socket low	6.00 - 7.50 mm plug low p. 22 socket low p. 23	7.50 - 9.00 mm plug mid p. 24 socket low p. 23	12.00 - 13.50 mm plug high p. 26 socket low p. 23	13.50 - 15.00 mm plug x-high p. 28 socket low p. 23
	socket mid	9.00 - 10.50 mm plug low p. 22 socket mid p. 25	10.50 - 12.00 mm plug mid p. 24 socket mid p. 25	15.00 - 16.50 mm plug high p. 26 socket mid p. 25	16.50 - 18.00 mm plug x-high p. 28 socket mid p. 25
	socket high <i>coming soon</i>	12.00 - 13.50 mm plug low p. 22 socket high p. 27	13.50 - 15.00 mm plug mid p. 24 socket high p. 27	18.00 - 19.50 mm plug high p. 26 socket high p. 27	19.50 - 21.00 mm plug x-high p. 28 socket high p. 27

Connection for min. PCB distance

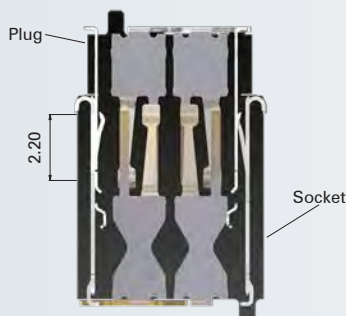

The minimum possible board-to-board distance is achieved by plugging the connector all the way into the stop position.

Connection for max. PCB distance

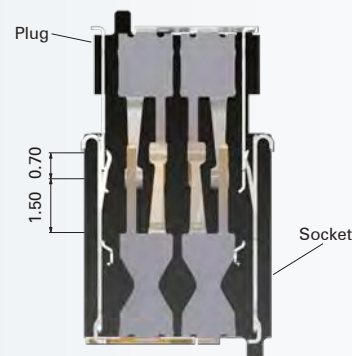

The plug and socket can be inserted anywhere within a range of 1.5 mm, thus allowing for the maximum possible board-to-board distance. The remaining 0.7 mm ensure secure contact mating.

Misalignment Zero8 Connectors

Allowed misalignment tolerances

longitudinal: ± 0.7 mm

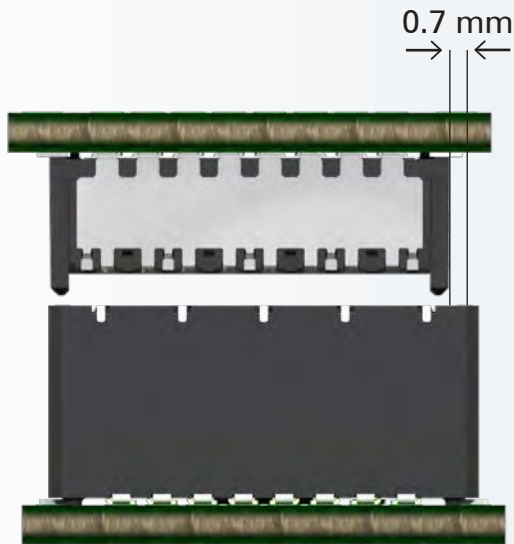

transverse: ± 0.7 mm

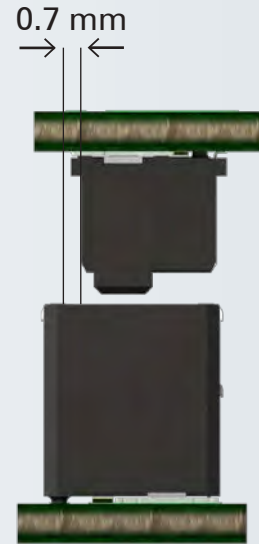

Angular Inclination Zero8 Connectors

Allowed angular inclination tolerances

longitudinal: $\pm 2^\circ$

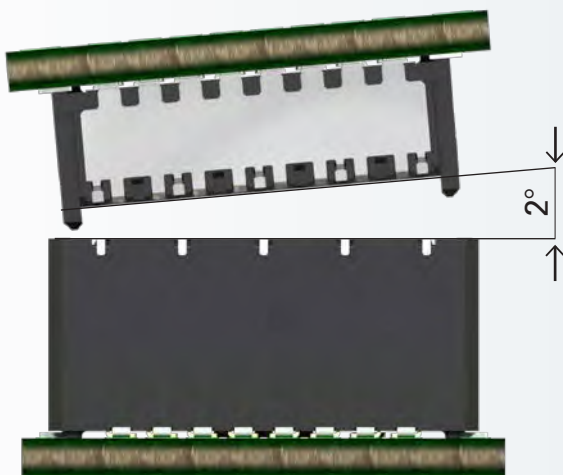

transverse: $\pm 4^\circ$

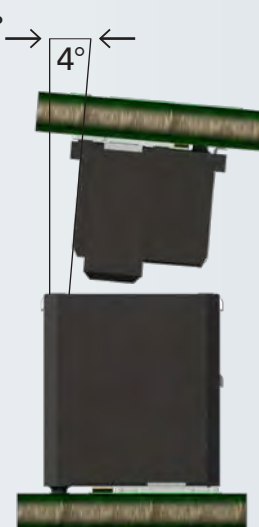

Electromagnetic Compatibility

The double sided shielding concept guarantees a interference-free HighSpeed transfer for the industrial environment: The utilized shielding material works especially well for components with high electromagnetic compatibility requirements and guarantees a coupling inductivity of max. 10pH for the connector.

Electric and magnetic field strength influence of the connector can be simulated through the coupling inductivity.

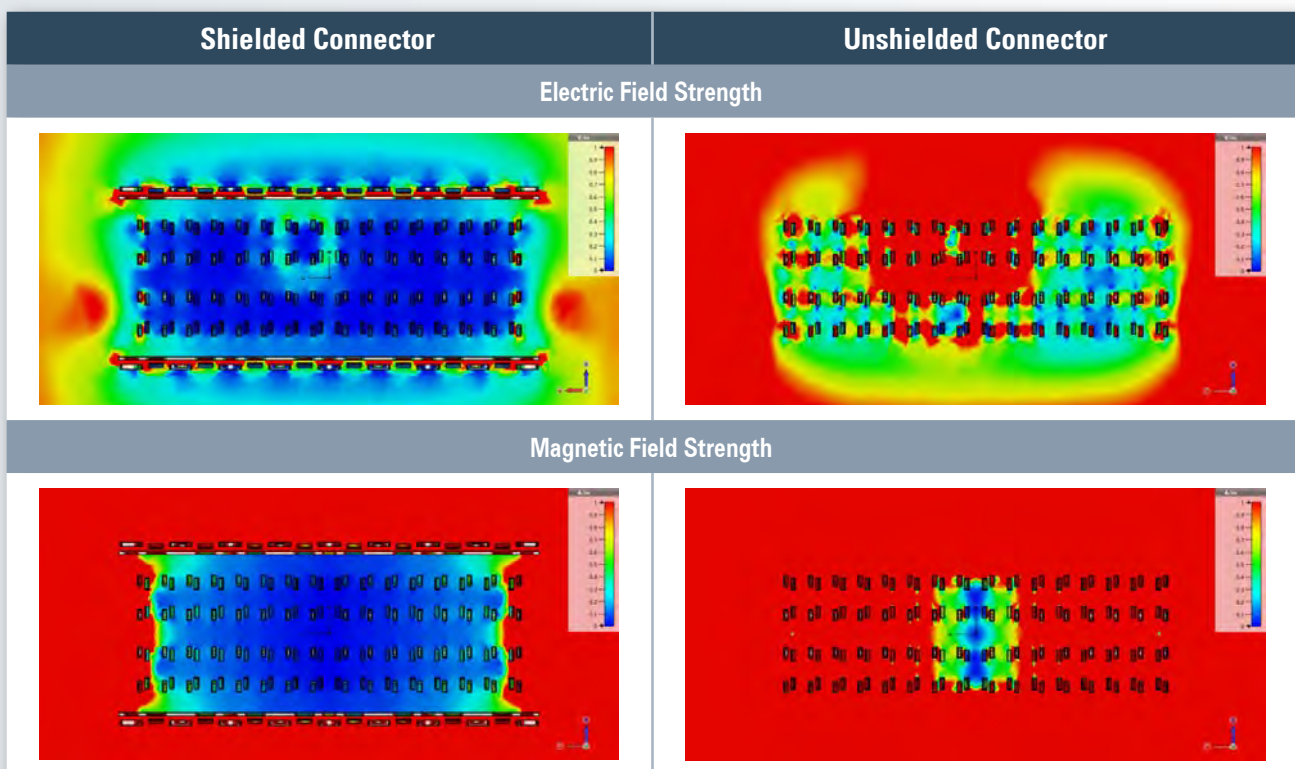

The extensive shielding concept uses multiple contact points to channel interferences away from mass connections.

Secure connections of individual PCB distances of 6 - 21 mm are guaranteed by the shielding concept's extended mating area of 2.2 mm.

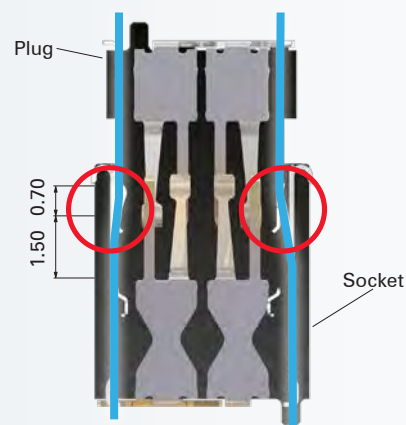

The continuously evolving digitalisation in all sectors, (industrial) Internet of Things, Industry 4.0, Smart Grid as well as Smart Home, requires HighSpeed data transfers from sensor to cloud. Signals of up to 16 Gbps and faster need to be transferred reliably and have to exhibit a high electromagnetic compatibility. Disruptions, corruption and especially interruptions of the transferred data should be prevented, which makes EMC protection more relevant than ever. To ensure EMC, outgoing as well as incoming disruption has to be reduced. Proper EMC shielding makes both possible. Applications, which act as a disrupting source as well as disrupting sink, can be protected through EMC shielding and won't influence neighboring components.

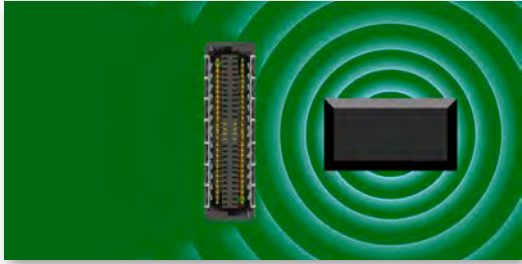
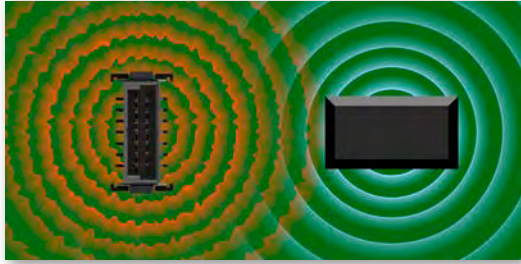
Shielded Connector	Unshielded Connector
Shielding enables closer placement of individual components to each other.	
	
Protection like this is of utmost importance in todays trend of miniaturisation and increasing integration density!	

Examples of applications that require especially effective EMC protection are PLC/IO-controls, routers, human machine interfaces such as control and display units, cameras and intelligent sensors with bus connections such as light barriers, temperature-, pressure-, power- and water meters.



HighSpeed - Zero8

ScaleX provides the ideal solution for robust and industry-ready PCB-connections with HighSpeed transfer rates of up to 16 Gbps.

This data rate is achieved by an optimized contact design and materials that provide excellent electrical conductivity.

Simulations with the Zero8 connector at 16 Gbps exhibit an excellent signal integrity. S-Parameter can be provided for your application simulations. Please contact us for more information at sales@ept.de and ask for a free sample.

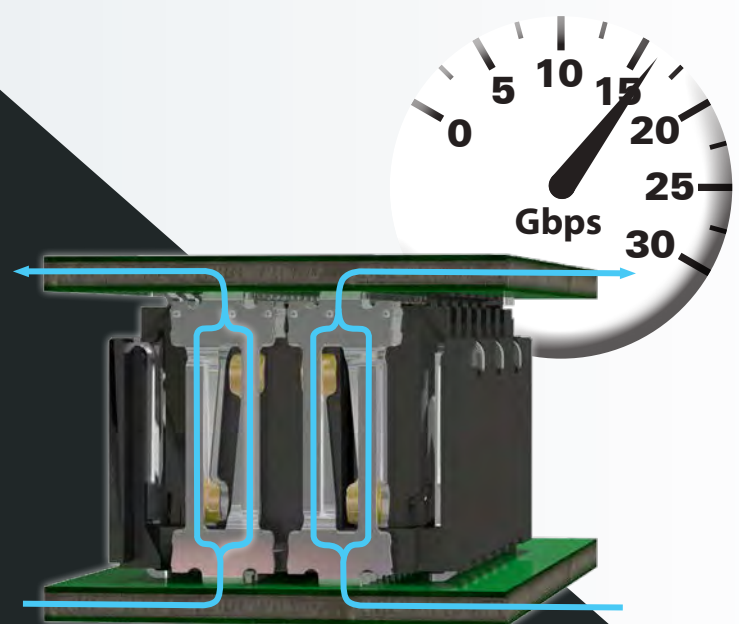
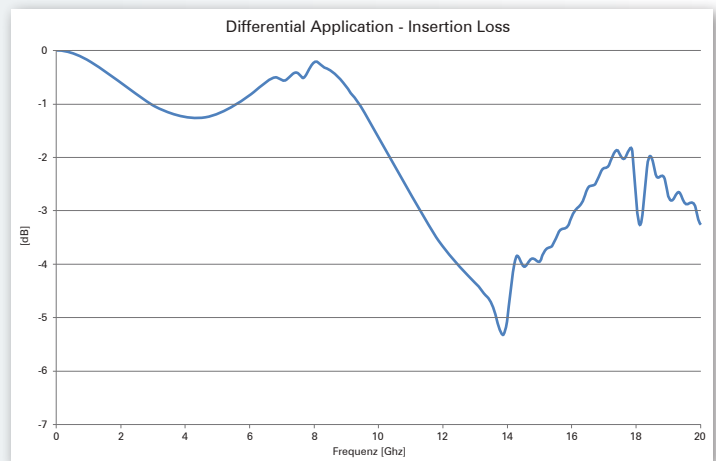

Technical specification	Zero8	
	Test Standard	0.8 mm SMT Board-to-Board Connectors
Basics		
Number of pins		12 / 20 / 32 / 52 / 80
Termination		SMT
Operating temperature range		-55°C bis +125°C
Material		
Insulator material		LCP, UL 94 V-0
CTI value	IEC 60112	150
Contact material		Copper alloy
Contact surface		Au over Ni
Termination area		Sn over Ni
Mechanical		
Pitch		0.8 mm
Mating- and separating force per Contact shielded / unshielded		$\leq 0.5 \text{ N} / \leq 0.4 \text{ N}$
Durability	IEC 60512-9-1:2010	Performance level I: 500 mating cycles
Coplanarity		max. 0.1 mm
Vibration, sinusoidal	IEC 60512-6-4:2002	10 - 2000 Hz 20 g
Contact mating problems if vibrations occur, sinusoidal	IEC 60512-2-5:2003	$\leq 1 \mu\text{s}$
Shock, semi-sinusoidal	IEC 60512-6-3:2002	50 g 11 ms
Contact mating problems if shocks occur, semi-sinusoidal	IEC 60512-2-5:2003	$\leq 1 \mu\text{s}$
Electrical		
Operational current	IEC 60512-5-2:2002	max. 1.7 A at 20°C (52 pins) max. 5.5 A at 20°C (2 of 52 pins)
Contact resistance	IEC 60512-2-1:2002	max. 25 mΩ
Clearance and creepage		min. 0.25 mm
Insulation resistance	IEC 60512-3-1:2002	min. 5 GΩ
Test voltage	IEC 60512-4-1:2003	500 V AC
Data transfer rate		16 Gbps
Coupling inductivity		10 pH
Processing		
Soldering temperature	JEDEC J-STD-020E	260°C
MSL	JEDEC J-STD-020E	1
Packaging		Tape and Reel
Assembly		Pick and place
Approval		
UL file		E130314
Environment		RoHS compliant

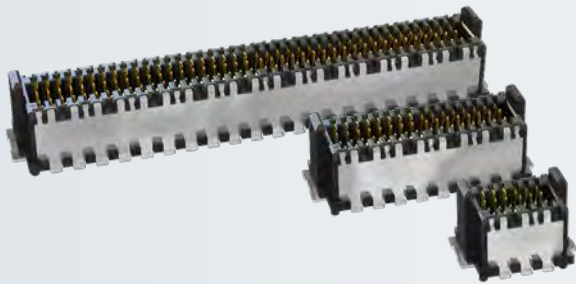

Type: Plug straight low-profile
1.15 mm unmated

Number of pins: 12 to 80

Pitch: 0.8 mm

Operational current: max. 1.7 A at 20°C (52 pins)
max. 5.5 A at 20°C (2 of 52 pins)

Packaging: Tape & Reel

Approval:

Technical Specifications on page 21



Plug low-profile - Performance Level I

Number of pins	Part number	PU (Tape & Reel)
12	405-52112-51	500
20	405-52120-51	
32	405-52132-51	
52	405-52152-51	
80	405-52180-51	

On request

- different number of pins
- other performance level

Mating connector / Application:

- for parallel applications (S. 23, 25, 27)
- for perpendicular applications (S. 31)

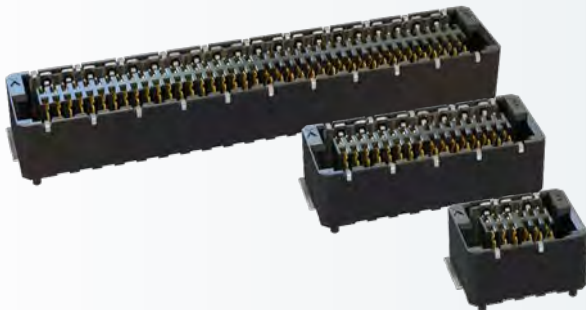

Type: Socket straight low-profile
4.85 mm unmated

Number of pins: 12 to 80

Pitch: 0.8 mm

Operational current: max. 1.7 A at 20°C (52 pins)
max. 5.5 A at 20°C (2 of 52 pins)

Packaging: Tape & Reel

Approval:  

Technical Specifications on page 21



Socket low-profile - Performance Level I

Number of pins	Part number	PU (Tape & Reel)
12	406-52112-51	500
20	406-52120-51	
32	406-52132-51	
52	406-52152-51	
80	406-52180-51	

On request

- different number of pins
- other performance level

Mating connector / Application:



for parallel applications (S. 22, 24, 26, 28)



for perpendicular applications (S. 30)



Type: Plug straight mid-profile
2.65 mm unmated

Number of pins: 12 to 80

Pitch: 0.8 mm

Operational current: max. 1.7 A at 20°C (52 pins)
max. 5.5 A at 20°C (2 of 52 pins)

Packaging: Tape & Reel

Approval:

Technical Specifications on page 21



Plug mid-profile - Performance Level I

Number of pins	Part number	PU (Tape & Reel)
12	405-53112-51	250
20	405-53120-51	
32	405-53132-51	
52	405-53152-51	
80	405-53180-51	

On request

- different number of pins
- other performance level

Mating connector / Application:

- for parallel applications (S. 23, 25, 27)
- for perpendicular applications (S. 31)

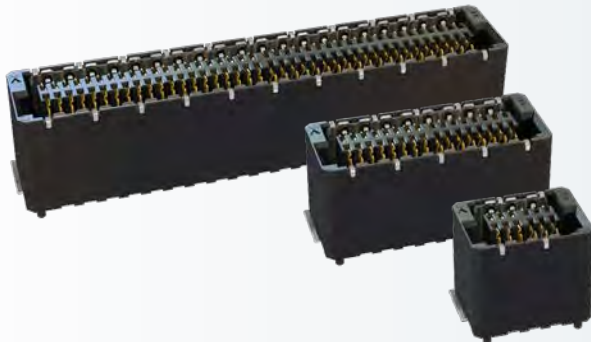

Type: Socket straight mid-profile
7.85 mm unmated

Number of pins: 12 to 80

Pitch: 0.8 mm

Operational current: max. 1.7 A at 20°C (52 pins)
max. 5.5 A at 20°C (2 of 52 pins)

Packaging: Tape & Reel

Approval:  

Technical Specifications on page 21



Socket mid-profile - Performance Level I

Number of pins	Part number	PU (Tape & Reel)
12	406-53112-51	250
20	406-53120-51	
32	406-53132-51	
52	406-53152-51	
80	406-53180-51	

On request

- different number of pins
- other performance level

Mating connector / Application:



for parallel applications (S. 22, 24, 26, 28)



for perpendicular applications (S. 30)

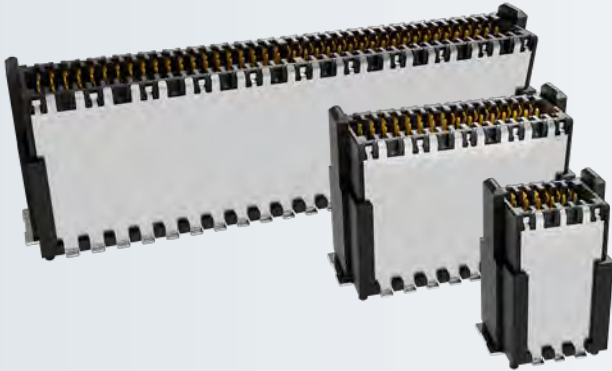

Type: Plug straight high-profile
7.15 mm unmated

Number of pins: 12 to 80

Pitch: 0.8 mm

Operational current: max. 1.7 A at 20°C (52 pins)
max. 5.5 A at 20°C (2 of 52 pins)

Packaging: Tape & Reel

Approval:  

Technical Specifications on page 21



Plug high-profile - Performance Level I

Number of pins	Part number	PU (Tape & Reel)
12	405-54112-51	250
20	405-54120-51	
32	405-54132-51	
52	405-54152-51	
80	405-54180-51	

On request

- different number of pins
- other performance level

Mating connector / Application:



for parallel applications (S. 23, 25, 27)



for perpendicular applications (S. 31)

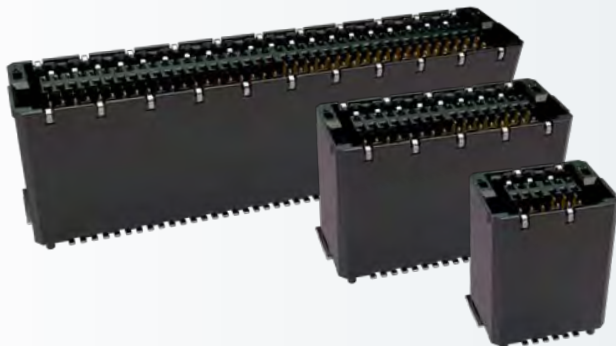

Type: Socket straight high-profile
10.85 mm unmated

Number of pins: 12 to 80

Pitch: 0.8 mm

Operational current: max. 1.7 A at 20°C (52 pins)
max. 5.5 A at 20°C (2 of 52 pins)

Packaging: Tape & Reel

Approval:  

Technical Specifications on page 21



Socket high-profile - Performance Level I

Number of pins	Part number	PU (Tape & Reel)
12	coming soon	250
20	coming soon	
32	coming soon	
52	coming soon	
80	coming soon	

On request

- different number of pins
- other performance level

Mating connector / Application:

-  for parallel applications (S. 22, 24, 26, 28)
-  for perpendicular applications (S. 30)



Type: Plug straight x-high-profile
8.65 mm unmated

Number of pins: 12 to 80

Pitch: 0.8 mm

Operational current: max. 1.7 A at 20°C (52 pins)
max. 5.5 A at 20°C (2 of 52 pins)

Packaging: Tape & Reel

Approval:  

Technical Specifications on page 21



Plug x-high-profile - Performance Level I

Number of pins	Part number	PU (Tape & Reel)
12	405-55112-51	250
20	405-55120-51	
32	405-55132-51	
52	405-55152-51	
80	405-55180-51	

On request

- different number of pins
- other performance level

Mating connector / Application:



for parallel applications (S. 23, 25, 27)



for perpendicular applications (S. 31)

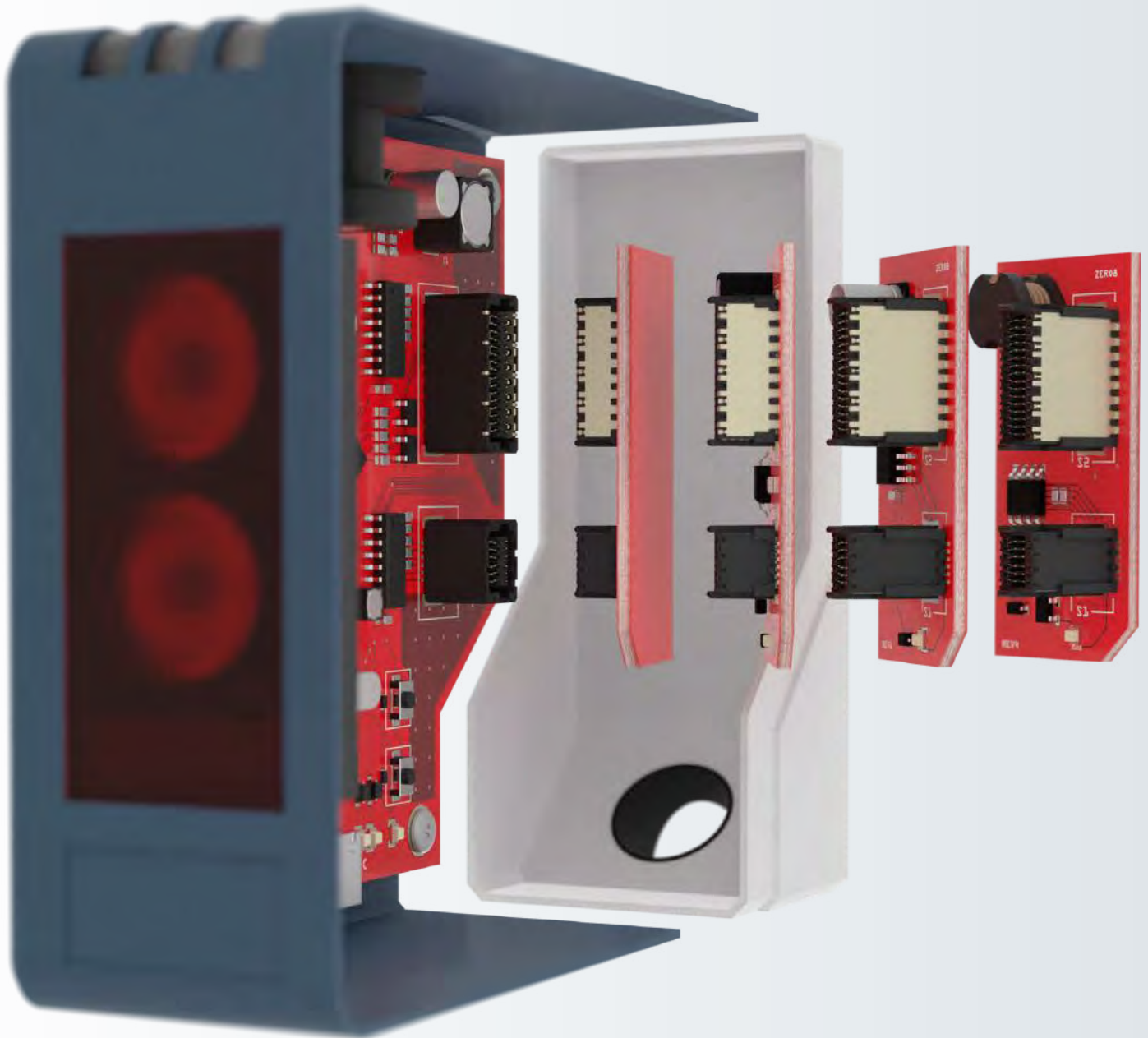

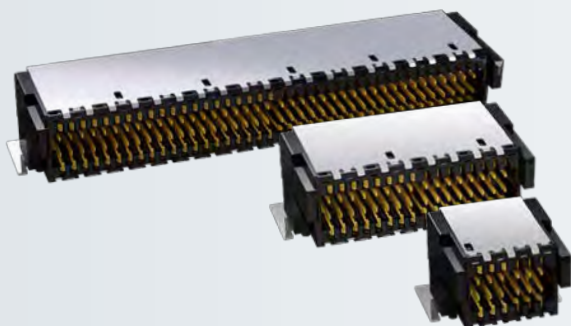

Type: Plug angled

Number of pins: 12 to 80

Pitch: 0.8 mm

Operational current: max. 1.7 A at 20°C (52 pins)
max. 5.5 A at 20°C (2 of 52 pins)

Packaging: Tape & Reel

Approval:

Technical Specifications on page 21



Plug angled - Performance Level I

Number of pins	Part number	PU (Tape & Reel)
12	405-51112-51	250
20	405-51120-51	
32	405-51132-51	
52	405-51152-51	
80	405-51180-51	

On request

- different number of pins
- other performance level

Mating connector / Application:

- for parallel applications (S. 31)
- for perpendicular applications (S. 23, 25, 27)

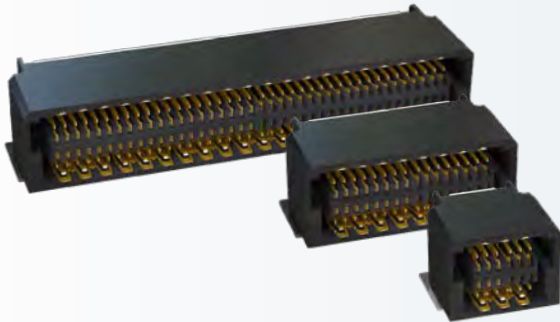

Type: Socket angled

Number of pins: 12 to 80

Pitch: 0.8 mm

Operational current: max. 1.7 A at 20°C (52 pins)
max. 5.5 A at 20°C (2 of 52 pins)

Packaging: Tape & Reel

Approval:  

Technical Specifications on page 21



Socket angled - Performance Level I

Number of pins	Part number	PU (Tape & Reel)
12	406-51112-51	250
20	406-51120-51	
32	406-51132-51	
52	406-51152-51	
80	406-51180-51	

On request

- different number of pins
- other performance level

Mating connector / Application:



for parallelo applications (S. 30)



for perpendicular applications (S. 22, 24, 26, 28)

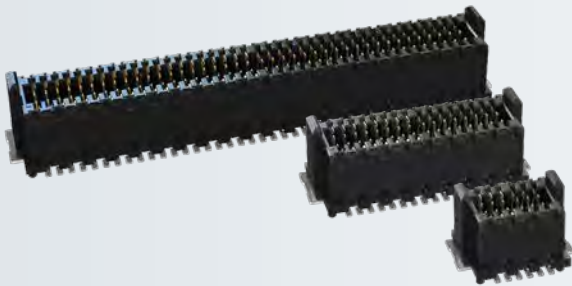

Type: Plug straight low-profile
1.15 mm unmated

Number of pins: 12 to 80

Pitch: 0.8 mm

Operational current: max. 1.7 A at 20°C (52 pins)
max. 5.5 A at 20°C (2 of 52 pins)

Packaging: Tape & Reel

Approval:

Technical Specifications on page 21



Plug low-profile - Performance Level I

Number of pins	Part number	PU (Tape & Reel)
12	405-52012-51	500
20	405-52020-51	
32	405-52032-51	
52	405-52052-51	
80	405-52080-51	

On request

- different number of pins
- other performance level

Mating connector / Application:

- for parallel applications (S. 33, 35, 37)
- for perpendicular applications (S. 41)

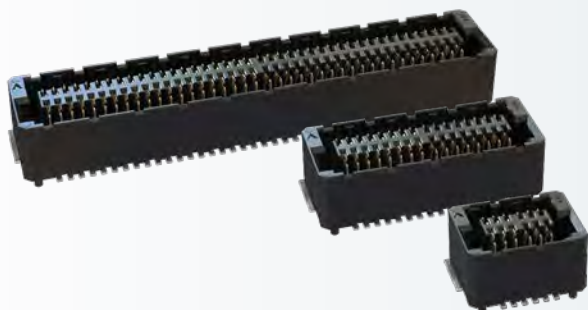

Type: Socket straight low-profile
4.85 mm unmated

Number of pins: 12 to 80

Pitch: 0.8 mm

Operational current: max. 1.7 A at 20°C (52 pins)
max. 5.5 A at 20°C (2 of 52 pins)

Packaging: Tape & Reel

Approval:  

Technical Specifications on page 21



Socket low-profile - Performance Level I

Number of pins	Part number	PU (Tape & Reel)
12	406-52012-51	500
20	406-52020-51	
32	406-52032-51	
52	406-52052-51	
80	406-52080-51	

On request

- different number of pins
- other performance level

Mating connector / Application:

-  for parallel applications (S. 32, 34, 36, 38)
-  for perpendicular applications (S. 40)

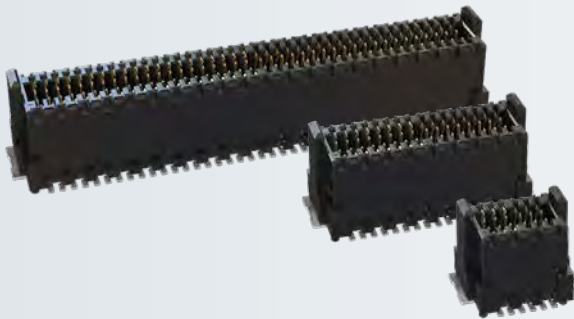

Type: Plug straight mid-profile
2.65 mm unmated

Number of pins: 12 to 80

Pitch: 0.8 mm

Operational current: max. 1.7 A at 20°C (52 pins)
max. 5.5 A at 20°C (2 of 52 pins)

Packaging: Tape & Reel

Approval:

Technical Specifications on page 21



Plug mid-profile - Performance Level I

Number of pins	Part number	PU (Tape & Reel)
12	405-53012-51	250
20	405-53020-51	
32	405-53032-51	
52	405-53052-51	
80	405-53080-51	

On request

- different number of pins
- other performance level

Mating connector / Application:

- for parallel applications (S. 33, 35, 37)
- for perpendicular applications (S. 41)

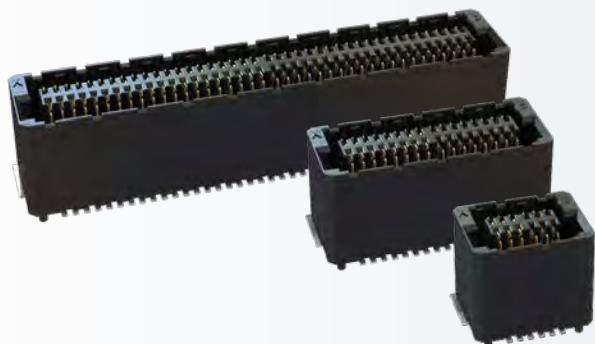

Type: Socket straight mid-profile
7.85 mm unmated

Number of pins: 12 to 80

Pitch: 0.8 mm

Operational current: max. 1.7 A at 20°C (52 pins)
max. 5.5 A at 20°C (2 of 52 pins)

Packaging: Tape & Reel

Approval:  

Technical Specifications on page 21



Socket mid-profile - Performance Level I

Number of pins	Part number	PU (Tape & Reel)
12	406-53012-51	250
20	406-53020-51	
32	406-53032-51	
52	406-53052-51	
80	406-53080-51	

On request

- different number of pins
- other performance level

Mating connector / Application:

-  for parallel applications (S. 32, 34, 36, 38)
-  for perpendicular applications (S. 40)

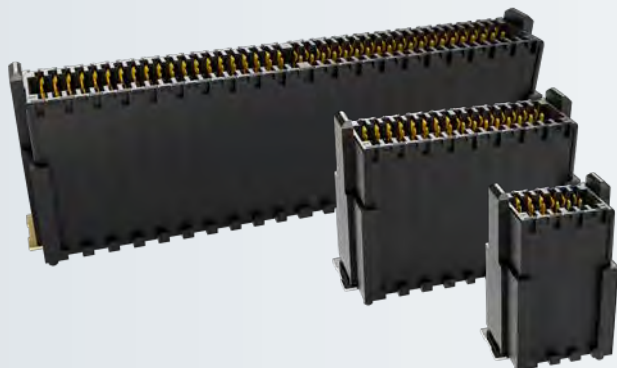

Type: Plug straight high-profile
7.15 mm unmated

Number of pins: 12 to 80

Pitch: 0.8 mm

Operational current: max. 1.7 A at 20°C (52 pins)
max. 5.5 A at 20°C (2 of 52 pins)

Packaging: Tape & Reel

Approval:

Technical Specifications on page 21



Plug high-profile - Performance Level I

Number of pins	Part number	PU (Tape & Reel)
12	405-54012-51	250
20	405-54020-51	
32	405-54032-51	
52	405-54052-51	
80	405-54080-51	

On request

- different number of pins
- other performance level

Mating connector / Application:

- for parallel applications (S. 33, 35, 37)
- for perpendicular applications (S. 41)

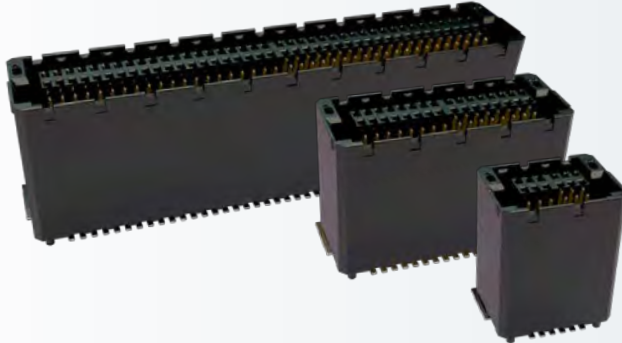

Type: Socket straight high-profile
10.85 mm unmated

Number of pins: 12 to 80

Pitch: 0.8 mm

Operational current: max. 1.7 A at 20°C (52 pins)
max. 5.5 A at 20°C (2 of 52 pins)

Packaging: Tape & Reel

Approval:  

Technical Specifications on page 21



Socket high-profile - Performance Level I

Number of pins	Part number	PU (Tape & Reel)
12	coming soon	250
20	coming soon	
32	coming soon	
52	coming soon	
80	coming soon	

On request

- different number of pins
- other performance level

Mating connector / Application:

-  for parallel applications (S. 32, 34, 36, 38)
-  for perpendicular applications (S. 40)

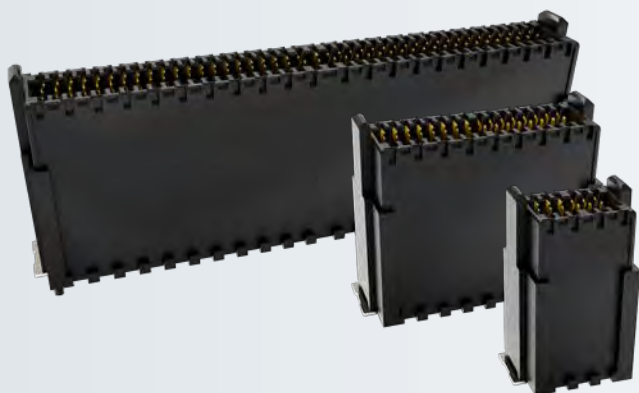

Type: Plug straight x-high-profile
8.65 mm unmated

Number of pins: 12 to 80

Pitch: 0.8 mm

Operational current: max. 1.7 A at 20°C (52 pins)
max. 5.5 A at 20°C (2 of 52 pins)

Packaging: Tape & Reel

Approval:

Technical Specifications on page 21



Plug x-high-profile - Performance Level I

Number of pins	Part number	PU (Tape & Reel)
12	405-55012-51	250
20	405-55020-51	
32	405-55032-51	
52	405-55052-51	
80	405-55080-51	

On request

- different number of pins
- other performance level

Mating connector / Application:

- for parallel applications (S. 33, 35, 37)
- for perpendicular applications (S. 41)





Type: Plug angled

Number of pins: 12 to 80

Pitch: 0.8 mm

Operational current: max. 1.7 A at 20°C (52 pins)
max. 5.5 A at 20°C (2 of 52 pins)

Packaging: Tape & Reel

Approval:

Technical Specifications on page 21



Plug angled - Performance Level I

Number of pins	Part number	PU (Tape & Reel)
12	405-51012-51	250
20	405-51020-51	
32	405-51032-51	
52	405-51052-51	
80	405-51080-51	

On request

- different number of pins
- other performance level

Mating connector / Application:

- for parallel applications (S. 41)
- for perpendicular applications (S. 33, 35, 37)

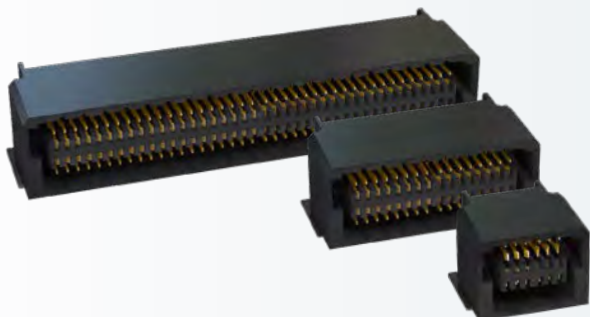

Type: Socket angled

Number of pins: 12 to 80

Pitch: 0.8 mm

Operational current: max. 1.7 A at 20°C (52 pins)
max. 5.5 A at 20°C (2 of 52 pins)

Packaging: Tape & Reel

Approval:  

Technical Specifications on page 21



Socket angled - Performance Level I

Number of pins	Part number	PU (Tape & Reel)
12	406-51012-51	250
20	406-51020-51	
32	406-51032-51	
52	406-51052-51	
80	406-51080-51	

On request

- different number of pins
- other performance level

Mating connector / Application:



for parallelo applications (S. 40)



for perpendicular applications (S. 32, 34, 36, 38)

ept designs, produces and distributes electronic connectors for highquality applications. Founded by Bernhard Guglhör over 45 years ago, we are proud to remain an independent and family owned company. Today, we employ about 1.200 people at six locations worldwide.

Over decades we have built trusting and successful partnerships with our customers, who are the primary focus of all. Our products and core competencies are used in high-level applications.

With our motto "Precision with Passion" ept stands for the highest quality and reliability under the personal and individual touch of dedicated employees.

We are looking forward to working with you.
Your ept-Team

ept GmbH

Bergwerkstr. 50
86971 Peiting, Germany
Tel. +49 (0) 88 61 / 25 01 0
Fax +49 (0) 88 61 / 25 01 700
sales@ept.de

ept, inc.

1624 Ashton Park Dr.
South Chesterfield, VA 23834, USA
Tel. +1 804 530 0820
800 323 2568
Fax +1 804 530 0837
sales@eptusa.com

**ept Electronic Precision
Technology (Shanghai) Ltd.**
6F Building 37,
No. 333 Qin Jiang Road
Shanghai, P. R. China
Post code: 20 02 33
Tel. +86 (0) 21-54 26-09 88
Fax +86 (0) 21-64 95-39 49
sales@eptcn.com



www.zero8.ept.de

Scan here for a free sample box!