

Laird
TECHNOLOGIES®



www.atd-elektronik.cz
www.atd-shop.com



global solutions :
local support™

| Knitted Conductive
EMI Gaskets

engineered antenna, emi, telematics and thermal applications



www.atd-elektronik.cz
www.atd-shop.com

Laird Technologies is committed to providing the world's leading OEMs with comprehensive solutions for their antenna, EMI shielding, telematics and thermal management requirements.

A world-leader, Laird Technologies has unrivaled product lines, dedication to ongoing R&D and a seamless network of manufacturing and customer support facilities located across the globe – most importantly, near its customers.

The company's philosophy of 'global solutions and local support' coupled with decades of experience and considerable capabilities means it has become a key partner for OEMs manufacturing in the following industries:

















- Aerospace
- Automotive electronics
- Computer
- Data communications
- General electronics
- Medical equipment
- Military
- Network equipment
- Telecommunications

global solutions :
local support™

TABLE OF CONTENTS

The EMI products presented in this section represent Laird Technologies' ongoing commitment to provide the design engineer with a complete range of solutions for controlling electromagnetic leakage along enclosure access doors and panels.

To help the designer comply with susceptibility and emission criteria for both commercial and military specifications, this section provides both design assistance and a comprehensive listing of products that best fit electrical, mechanical, and environmental EMI application requirements.

	Visual Part Reference Guide	3		ElectroNit Enviro-Seal EMI Gasketing	15
	Part Number Cross Reference	4		Enviro-Seal Strips with PSA	16
	Introduction to Knitted Conductive EMI Gaskets	5		Enviro-Seal Double Shield Strips with PSA	16
	Ordering Information for Gaskets with PSA on Fin	5		Fabricated Enviro-Seal Gaskets	17
	Mechanical Considerations	6		Electronit Super Soft	18
	Environmental Considerations	8		ElectroNit Elastomer Core EMI Gasketing	19
	UltraFlex ElectroNit Beryllium Copper			Rectangular with Sponge Elastomer	20
	Knitted Wire Shielding	9		Round with Sponge Elastomer	20
	Hollow Core Round	10		Round with Silicone Elastomer Tubing	20
	Hollow Core Round with Single Fin	10		Single Fin with Sponge Elastomer	20
	Hollow Core Double Round	10		Double Fin with Sponge Elastomer	21
	UltraFlex D with PSA	10		Single Fin with Silicone Elastomer Tubing	21
	Fabricated UltraFlex Gaskets	11		Double Fin with Silicone Elastomer Tubing	21
				Fabricated Elastomer Core Gaskets	22
	ElectroNit All Mesh EMI Gasketing	12		Electro-Ground EMI Washers	23-26
	All Mesh Single Round with Fin Strip	13		ElectroMesh Tape	27
	All Mesh Double Round with Fin Strip	13		UltraSoft Knit Gaskets	28-29
	All Mesh Rectangular Strip	13		Corrosion of EMI Gaskets	30
	All Mesh Round Strip	13		CorrosionMetals Galvanic compatibility chart	31-32
	Fabricated All Mesh Gaskets	14		NOTES	33-34



www.atd-elektronik.cz
www.atd-shop.com



KNITTED CONDUCTIVE EMI GASKETS

UltraFlex ElectroNit BeCu Knitted Wire Shielding

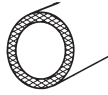

Hollow Core Round

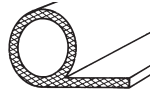

Hollow Core Round with Single Fin



Hollow Core Double Round

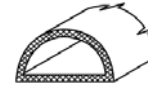

UltraFlex "D" Shape

Pages 9-11

ElectroNit All Mesh EMI Gasketing

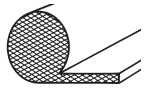

All Mesh Single Round with Fin Strip

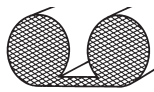

All Mesh Double Round with Fin Strip

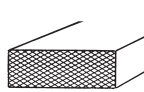

All Mesh Rectangular Strip

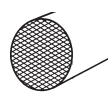

All Mesh Round Strip

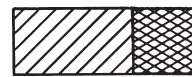

Enviro-Seal Strip with Pressure-Sensitive Adhesive



Double Shield Enviro-Seal Strip with Pressure-Sensitive Adhesive

Pages 12-14

ElectroNit Elastomer Core EMI Gasketing

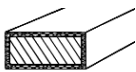

Rectangular with Sponge Elastomer



Round with Sponge Elastomer

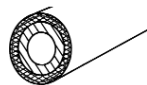

Round with Silicone Elastomer Tubing

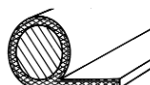

Single Fin with Sponge Elastomer

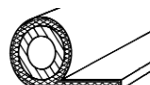

Single Fin with Silicone Elastomer Tubing

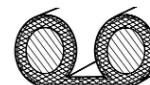

Double Fin with Sponge Elastomer



Double Fin with Silicone Elastomer Tubing

Page 19-22

Electronit supersoft

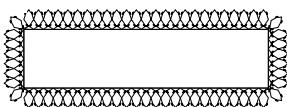

Page 18

ElectroGround EMI Washers

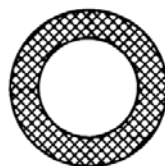

Pages 23-26

ElectroMesh Tape

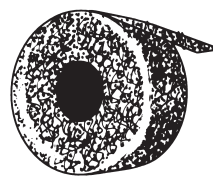

Page 27

UltraSoft Knit

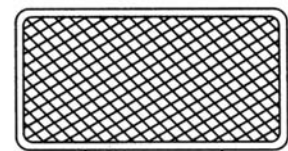

Pages 28-29



When ordering, please call our sales department to confirm availability and lead times.

KNITTED CONDUCTIVE EMI GASKETS

PART NO.	PRODUCT	PAGE NO.
8101-01XX-40,41,47,48,49	ULTRAFLEX ELECTRONIT HOLLOW CORE ROUND	Page 10
8102-02XX-40,41,47,48,49	ULTRAFLEX D ELECTRONIT WITH PSA	Page 10
8103-01XX-40,41,47,48,49	ULTRAFLEX ELECTRONIT HOLLOW CORE ROUND WITH SINGLE FIN	Page 10
8104-01XX-40,41,47,48,49	ULTRAFLEX ELECTRONIT HOLLOW CORE DOUBLE ROUND	Page 10
8300-XXXX-40,42,43,44,46	ELECTROMESH TAPE	Page 27
8401-01XX-XX	ELECTRONIT ALL MESH RECTANGULAR STRIP	Page 13
8402-01XX-XX	ELECTRONIT ALL MESH ROUND STRIP	Page 13
8403-01XX-50,52,54,55,60,61	ELECTRONIT SINGLE FIN WITH SPONGE ELASTOMER	Page 20
8403-01XX-XX	ELECTRONIT ALL MESH SINGLE ROUND WITH FIN STRIP	Page 13
8404-01XX-XX	ELECTRONIT ALL MESH DOUBLE ROUND WITH FIN STRIP	Page 13
8405-01XX-50,52,54,55,60,61	ELECTRONIT ENVIRO-SEAL DOUBLE SHIELD STRIPS WITH PSA	Page 16
8406-01XX-50,52,54,55,60,61	ELECTRONIT ENVIRO-SEAL STRIPS WITH PSA	Page 16
8409-01XX-50,52,54,55,60,61	ELECTRONIT RECTANGULAR WITH SPONGE ELASTOMER	Page 20
8410-01XX-50,52,54,55,60,61	ELECTRONIT ROUND WITH SPONGE ELASTOMER	Page 20
8412-01XX-50,52,54,55,60,61	ELECTRONIT DOUBLE FIN WITH SPONGE ELASTOMER	Page 21
8413-01XX-56,64,65	ELECTRONIT ROUND WITH SILICONE ELASTOMER TUBING	Page 20
8414-01XX-56,64,65	ELECTRONIT SINGLE FIN WITH SILICONE ELASTOMER TUBING	Page 21
8415-01XX-56,64,65	ELECTRONIT DOUBLE FIN WITH SILICONE ELASTOMER TUBING	Page 21
843X-2XXX-X	ELECTRONIT SUPERSOFT	Page 18
8417-3XXX-62	ULTRASOFT KNIT GASKETS	Page 29
89XX-01XX-40,42,43,44,46	ELECTROGROUND EMI WASHERS	Page 24-26



www.atd-elektronik.cz
www.atd-shop.com



KNITTED CONDUCTIVE EMI GASKETS

EMI gasketing that best fits shielding requirements is determined by the environmental and mechanical considerations of the equipment to be shielded. This design guide is intended to aid the engineer in determining the product that will provide the optimum shielding effectiveness or grounding within mechanical constraints including metal thickness, material type, plating, bolt spacing, and interface dimensions.

ORDERING INFORMATION FOR GASKETS WITH PRESSURE-SENSITIVE ADHESIVE TAPE ON "FIN"

Depending on what your application demands, the pressure-sensitive adhesive tape can be provided either on the topside or the underside of the gasket. Here's how you specify:

1. If you want the pressure-sensitive adhesive tape on the top, specify those part numbers in which the fifth digit is an "8". For example: 8403-8XXX-XX.
2. If you want the pressure-sensitive adhesive on the under side, specify those part numbers in which the fifth digit is a "9". For example: 8403-9XXX-XX.

LOCATION OF PRESSURE-SENSITIVE ADHESIVE (PSA) ON FIN

FIGURE 1.

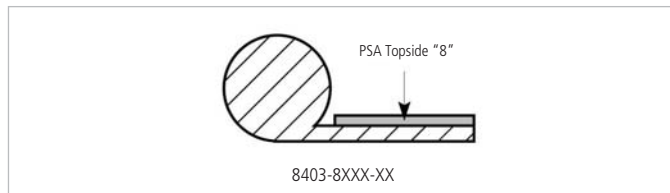
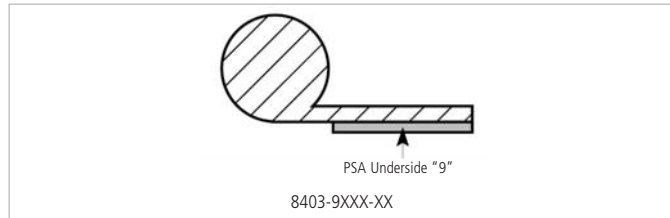

FIGURE 2.



The products shown are supplied on a spool by the foot, and can be installed by the customer by simply cutting to the desired length during assembly. It is recommended that a Laird Technologies engineer be contacted early in the design stage. The engineer can assist in designing a unit gasket assembly and can help determine whether it would be beneficial for gasketing to be provided in either frame form or cut to a specific length. On large production quantities, these techniques have proven to be very cost-effective, as the gasket is received as a finished item ready for installation.

FIGURES 3A THROUGH 3E ILLUSTRATE SEVERAL WIDELY USED TECHNIQUES FOR MOUNTING:

FIGURE 3A.

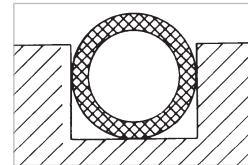

▲ Groove Mounting
In groove mounting, gasket should have sufficient clearance to achieve optimum contact when compressed to desired tolerance.

FIGURE 3B.

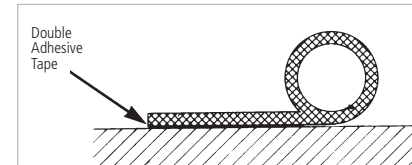

▲ Adhesive Mounting
Adhesive strip is applied only beneath the fin area, allowing the conductive knitted mesh direct contact with the host material.

FIGURE 3C.

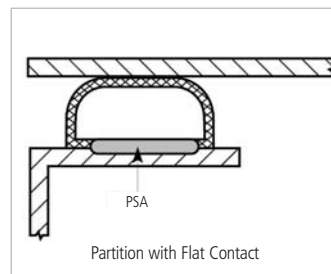

PSA
Partition with Flat Contact

FIGURE 3D.

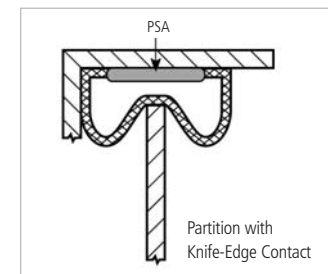

PSA
Partition with Knife-Edge Contact

FIGURE 3E.

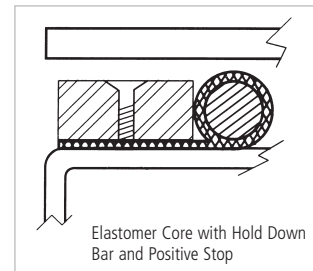

Elastomer Core with Hold Down Bar and Positive Stop





MECHANICAL CONSIDERATIONS

Gasket Interface Design

The optimum condition for an EMI gasket mounting is a rigid machined flat surface with bolts located outside the gasket contact area. This condition, however, is not practical or possible in most shielding applications. Therefore, choice of an EMI gasket that meets the required shielding effectiveness, and at the same time will be adapted to interface constraints of the enclosure package, are major considerations in designing an effective EMI gasket.

Flat Flange Mounting

The most common method of grounding between two mating surfaces is with a flat gasket mounted between surfaces as shown in Figure 4. This method is particularly effective in joints where there is an occasional need to open the enclosure for maintenance purposes. It is recommended that a positive stop be used to prevent overcompression of the gasket which could reduce effectiveness when the lid is secured after opening.

All gasket materials have an elastic limit and are subject to taking a set if overcompressed. Figures 5a and 5b show methods for incorporating a stop into the gasket enclosure design. It is recommended that stops be designed to the maximum suggested compression limits of the gasket material used.

FIGURE 4. FLAT GASKET BETWEEN SHEET METAL FLANGE

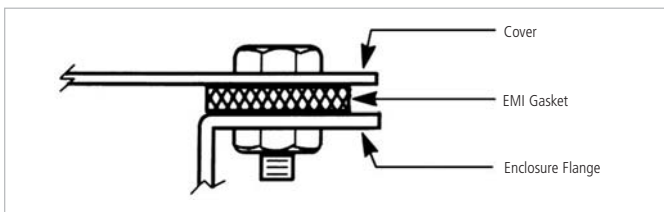

FIGURE 5A. COVER WITH COMPRESSION STOP

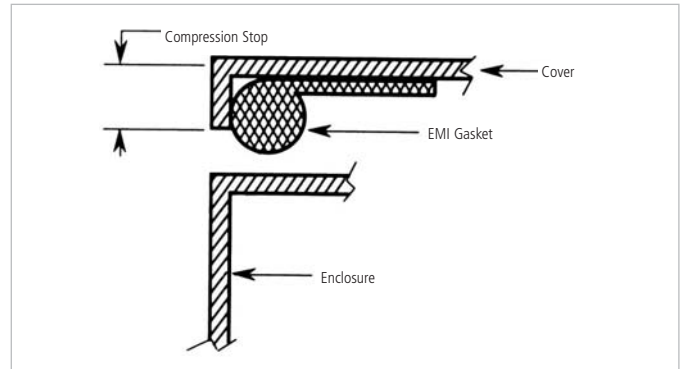
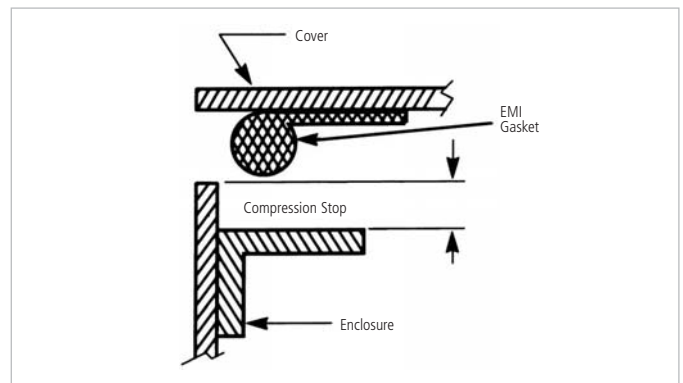

FIGURE 5B. COMPRESSION STOP BUILT INTO ENCLOSURE





EMI GASKET MATING SURFACES

During initial enclosure-gasket interface design, it is important that the impedance between the mating surfaces be as nearly equal to that of the enclosure material as possible. Any significant difference in surface impedance through the gasket material can produce fluctuations in current flow, resulting in the generation of EMI voltages. These fluctuating voltages can create the leakage of radiated energy into or from the enclosure. Features to consider in the gasket interface design are as follows:

1. Gasketed surfaces should be protected with a conductive coating such as tin, nickel, or zinc.
2. Mating surfaces should be as flat as possible considering the manufacturing method, i.e., bending or machining.
3. Mating surfaces should be cleaned of oxides prior to assembly of the gasketing material.

The mechanical aspects of EMI gasket interface design are an important factor in ensuring a reliable EMI shield. Joint unevenness, or the degree of mismatch of mating surfaces, is one of the most important design considerations. This match results when the mating surfaces make contact at irregular intervals due to surface roughness or bowing of the gasket interface due to improper material selection or thickness of the mating plates. Excessive bolt tightening, too few fasteners, or improper gasket selection can also affect gasket bowing. An effective EMI gasket should make continuous and uniform contact with the mating surfaces. The shielding performance of a gasketed enclosure can be adversely affected by improper mating of the gasketed interface due to joint unevenness.

To emphasize the effect of a gasketed joint, Figure 6a shows a seam without gasket material joining and touching only at the regular high spots between the surfaces. It is the function of an EMI gasket to bridge the gaps between these irregularities without losing the properties of resiliency or conductivity. The maximum joint unevenness is the dimension of the maximum separation between the flange of the seam when the two surfaces are touching. This separation is designated as ΔH , as shown in Figure 6a. With a gasket in place, the maximum spacing (H_1) between mating surfaces occurs at the minimum gasket compression. Conversely, the minimum spacing (H_2) occurs at the maximum gasket compression as shown in Figure 6b. The difference between the maximum (H_1) and the minimum (H_2) spacing is ΔH . Under these extreme conditions, the gasket undergoes its severest mechanical tests at the maximum deflection and severest electrical tests at the minimum deflection.

FIGURE 6A. UNEVEN JOINT WITHOUT GASKET

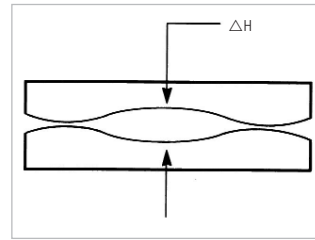
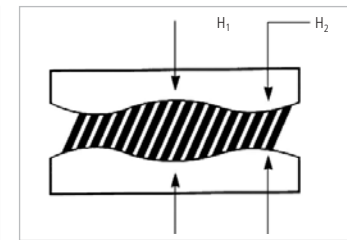

FIGURE 6B. UNEVEN JOINT WITH GASKET



With joint unevenness such a critical factor, it is important to consider the following when designing an EMI gasket or specific interface:

1. Gasket deflection
2. Compression set
3. Shielding effectiveness
4. Environmental sealing needs

These considerations can be related to the three classifications of joints, defined as follows:

Class 1 — Permanently mounted cover plates or assemblies. Generally, compression set is not a concern in these applications, even though high pressures may be encountered.

Class 2 — Access cover plate with high joint unevenness, which is opened frequently, but always closes on the same portion of the gasket. A hinged door is an example of a Class 2 joint.

Class 3 — A removable access plate, with symmetrically mounted fasteners, that is replaceable but not necessarily in the original orientation. Gaskets for this type of application are removable and reusable. Gasket materials which exhibit low closure force and low compression set are to be considered for this application.

Closure Force

Figure 7 on page 7 shows the relationship between shielding effectiveness and closure force. The minimum force (P_{MIN}) is the recommended applied force to establish good shielding effectiveness and to minimize the effect of minor pressure differences. The maximum recommended closure force (P_{MAX}) is based on two criteria: 1) maximum compression set of 10%; 2) avoidance of possible damage to the gasket material when pressure exceeds the recommended maximum. Both gasket materials have optimum performance at 25% to 30% deflection. Using the deflection versus pressure curves in the product descriptions of this catalog can determine the optimum pressure for the 25% deflection.





FIGURE 7. SHIELDING EFFECTIVENESS VS. COMPRESSION FORCE

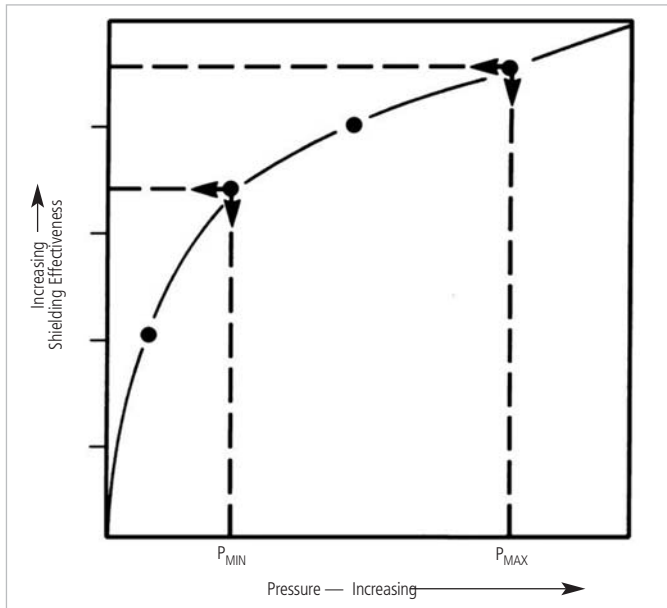

Compression Set

As previously mentioned, use of compression stops built into an enclosure or supplied with the EMI gasket aids in controlling the amount of deflection, thus minimizing the amount of compression set. Selection of a gasketing material for a joint which must be opened and closed is, to a large extent, determined by the compression set characteristics of the gasket material. Most resilient gasket materials will recover most of their original height after being deflected no greater than 25% – 30%. The difference between the original height and the height after the compression force is removed, is the compression set. Compression set increases as the deflection pressure is increased.

Environmental Considerations

The choice of gasket materials and surface finish of an enclosure is a function of the operating or storage temperature of the electronic package. Most electronic packages, however, must be designed for one of the following five general environments:

Class A — Controlled Environment — Temperature and humidity are controlled, generally indoor applications.

Class B — Uncontrolled Environment — Temperature and humidity are not controlled, exposed to humidities at 100% with occasional wetting, outdoor exposure or exposure in uncontrolled warehouses.

Class C — Marine Environment — Shipboard exposure or land exposure within two miles of salt water where conditions of Class A are not met.

Class D — Space Environment — Exposure to high vacuum and high radiation.

Class E — Nuclear, Biological, Chemical (NBC) — Applications subject to exposure to solvents used to break down NBC toxic substances.

Choice of an elastomer used in a knitted wire product for a resilient core is a function of the class in which the specific equipment will be operated or stored. The elastomer materials listed below are commonly used in conjunction with EMI gasketing materials, as bonded constructions such as the Enviro-Seal product, or the elastomer core products, defined in this catalog.

Neoprene

This elastomer is commonly used in conjunction with EMI gaskets in the Class A environment and will withstand temperatures ranging from -65°F to 212°F (-54°C to 100°C) for the solid material and -25°F to 212°F (-32°C to 100°C) for the closed cell sponge elastomer. The neoprene materials are the least expensive of the synthetic rubber materials and are best suited for commercial applications from a cost standpoint.

Silicone

This material has outstanding physical characteristics and will operate continuously at temperatures ranging from -80°F to 500°F (-62°C to 260°C) for solid and -103°F to 401°F (-75°C to 205°C) for closed cell sponge silicone. These materials remain flexible and are highly resistant to water and swelling in the presence of hydrocarbons.

Note:

For materials compatibility in a corrosive environment, see the Metals Galvanic Compatibility Chart on the inside back cover.





ULTRAFLEX® ELECTRONIT® BERYLLIUM COPPER KNITTED WIRE SHIELDING

UltraFlex® ElectroNit® combines the optimum mechanical properties of beryllium copper with shielding effectiveness as much as 20 dB higher than conventional materials. It offers superb resiliency for consistent, point-to-point contact requiring the lowest compression forces among all other shielding materials and configurations. A wide range of platings, sizes, configurations, and excellent flexibility create optimum design latitude.

- Compression force 80% less than conventional knitted wire shielding with elastomer core
- >90% recovery of original height at up to 75% deflection preserving shielding effectiveness values
- Optimum attenuating properties of beryllium copper, one of shielding's most effective materials
- Up to 75% lighter than conventional wire knit materials
- High cycle life for high traffic applications
- No moisture absorption
- Available in UltraFlex Lite single strand BeCu mesh, offering 50% load reduction from standard product
- Also offered in aluminum and stainless steel for increased galvanic compatibility with mating surfaces
- Other platings available upon request UltraFlex is supplied on spools in continuous minimum lengths of 25 ft. (7,6 m).

SHIELDING EFFECTIVENESS

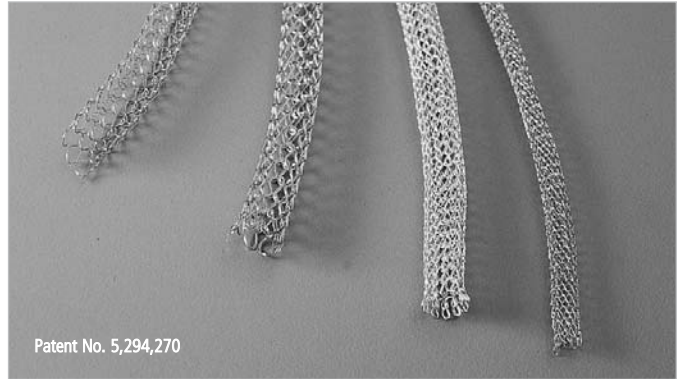
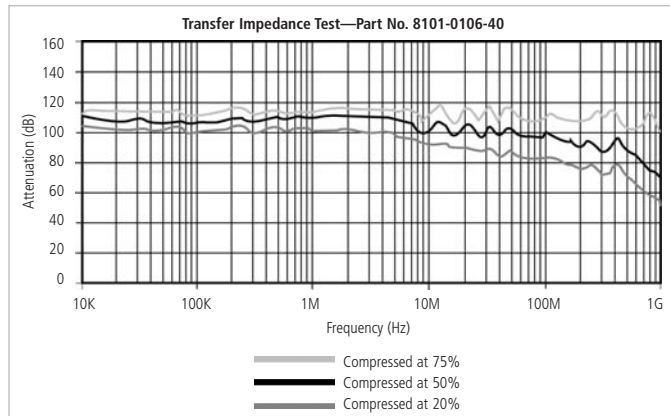

▲ Hollow core UltraFlex is available in round, round with single fin, double round configuration, and D shape.

Compression-Deflection

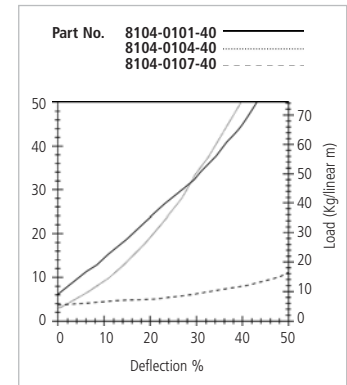
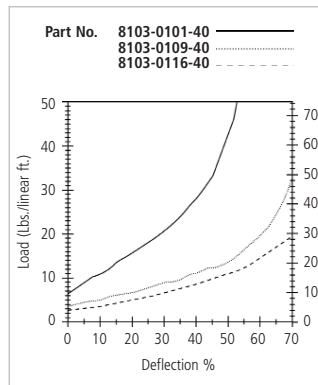
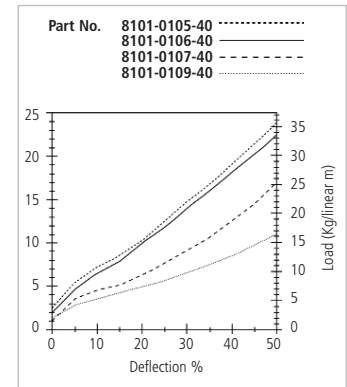
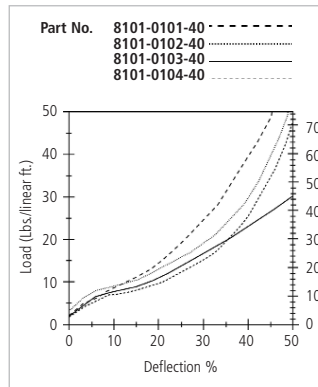

www.atd-elektronik.cz
www.atd-shop.com



SIZE VS. TOLERANCE: ULTRAFLEX HOLLOW CORE ROUND

Size Range	Tolerance	
	Diameter	
To 0.120 (3,1)	+ 0.020/- 0.000 (+0,5/-0,0)	
0.130 to 0.380 (3,3 to 9,7)	+ 0.030/- 0.000 (+0,8/-0,0)	
0.390 to 0.050 (9,9 to 12,7)	+ 0.046/- 0.000 (+1,2/-0,0)	
0.510 to 1.000 (13,0 to 25,4)	+ 0.062/- 0.000 (+1,6/-0,0)	

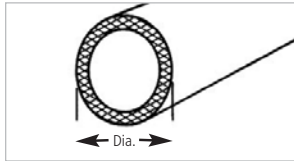

Groove Dimensions

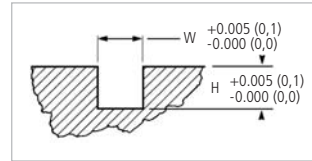

SIZE VS. TOLERANCE: ULTRAFLEX HOLLOW CORE ROUND WITH SINGLE FIN

Size Range	Tolerance	
	Dim W	Dim H
To 0.180 (4,6)	N/A	+ 0.020/- 0.000 (+0,5/-0,0)
0.190 to 0.380 (4,8 to 9,7)	+ 0.060/- 0.030 (+1,5/-0,8)	+ 0.030/- 0.000 (+0,8/-0,0)
0.390 to 0.050 (9,9 to 12,7)	+ 0.060/- 0.060 (+1,5/-1,5)	+ 0.046/- 0.000 (+1,2/-0,0)
0.510 to 1.000 (13,0 to 25,4)	+ 0.090/- 0.060 (+2,3/-1,5)	+ 0.062/- 0.000 (+1,6/-0,0)

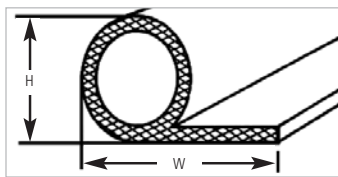

SIZE VS. TOLERANCE: ULTRAFLEX HOLLOW CORE DOUBLE ROUND

Size Range	Tolerance	
	Dim W	Dim H
To 0.180 (4,6)	N/A	+ 0.020/- 0.000 (+0,5/-0,0)
0.190 to 0.380 (4,8 to 9,7)	+ 0.060/- 0.030 (+1,5/-0,8)	+ 0.030/- 0.000 (+0,8/-0,0)
0.390 to 0.050 (9,9 to 12,7)	+ 0.060/- 0.060 (+1,5/-1,5)	+ 0.046/- 0.000 (+1,2/-0,0)
0.510 to 1.000 (13,0 to 25,4)	+ 0.090/- 0.060 (+2,3/-1,5)	+ 0.062/- 0.000 (+1,6/-0,0)

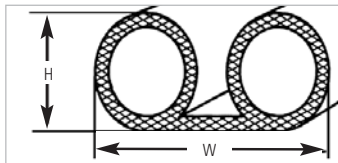

SIZE VS. TOLERANCE: ULTRAFLEX D WITH PSA

Size Range	Tolerance	
	Dim W	Dim H
0.120 to 0.250 (3,1 to 6,4)	+ 0.030/- 0.000 (+0,8/-0,0)	+ 0.030/- 0.000 (+0,8/-0,0)
0.260 to 0.380 (6,6 to 9,7)	+ 0.040/- 0.000 (+1,0/-0,0)	+ 0.040/- 0.000 (+1,0/-0,0)
0.390 to 0.050 (9,9 to 12,7)	+ 0.050/- 0.000 (+1,3/-0,0)	+ 0.040/- 0.000 (+1,0/-0,0)

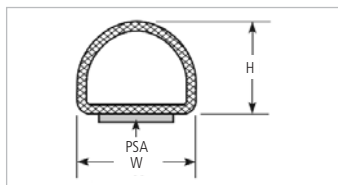

For Size vs. Tolerance charts, dimensions measured under 4 oz. load (11,3 gms) with 0.750 dia. (19,1 mm) anvil.

ULTRAFLEX HOLLOW CORE ROUND

Laird Technologies Part No.	Groove Dimensions		Diameter
	W	H	
8101-0101-40	0.047 (1,2)	0.060 (1,5)	0.062 (1,6)
8101-0102-40	0.069 (1,8)	0.090 (2,3)	0.093 (2,4)
8101-0103-40	0.093 (2,4)	0.120 (3,1)	0.125 (3,2)
8101-0104-40	0.117 (3,0)	0.150 (3,8)	0.156 (4,0)
8101-0105-40	0.140 (3,6)	0.180 (4,6)	0.187 (4,8)
8101-0106-40	0.187 (4,8)	0.240 (6,1)	0.250 (6,4)
8101-0107-40	0.234 (5,9)	0.292 (7,4)	0.312 (7,9)
8101-0108-40	0.281 (7,1)	0.360 (9,1)	0.375 (9,5)
8101-0109-40	0.375 (9,5)	0.485 (12,3)	0.500 (12,7)
8101-0135-40	0.563 (14,3)	0.730 (18,5)	0.750 (19,1)

ULTRAFLEX HOLLOW CORE ROUND WITH SINGLE FIN

Laird Technologies Part No.*	Width	Height
8103-0125-40	0.300 (7,6)	0.093 (2,4)
8103-0101-40	0.375 (9,5)	0.062 (1,6)
8103-0104-40	0.375 (9,5)	0.125 (3,2)
8103-0118-40	0.375 (9,5)	0.156 (4,0)
8103-0102-40	0.500 (12,7)	0.062 (1,6)
8103-0103-40	0.500 (12,7)	0.093 (2,4)
8103-0107-40	0.500 (12,7)	0.156 (4,0)
8103-0109-40	0.500 (12,7)	0.250 (6,4)
8103-0117-40	0.500 (12,7)	0.375 (9,5)
8103-0105-40	0.625 (15,9)	0.125 (3,2)
8103-0108-40	0.625 (15,9)	0.187 (4,8)
8103-0112-40	0.625 (15,9)	0.312 (7,9)
8103-0106-40	0.750 (19,1)	0.125 (3,2)
8103-0110-40	0.750 (19,1)	0.250 (6,4)
8103-0113-40	0.875 (22,2)	0.312 (7,9)
8103-0111-40	1.000 (25,4)	0.250 (6,4)
8103-0114-40	1.000 (25,4)	0.375 (9,5)
8103-0115-40	1.000 (25,4)	0.437 (11,1)
8103-0116-40	1.000 (25,4)	0.500 (12,7)

ULTRAFLEX HOLLOW CORE DOUBLE ROUND

Laird Technologies Part No.*	Width	Height
8104-0101-40	0.500 (12,7)	0.062 (1,6)
8104-0102-40	0.500 (12,7)	0.125 (3,2)
8104-0105-40	0.625 (15,9)	0.187 (4,8)
8104-0103-40	0.750 (19,1)	0.125 (3,2)
8104-0107-40	0.750 (19,1)	0.250 (6,4)
8104-0104-40	1.000 (25,4)	0.125 (3,2)
8104-0106-40	1.000 (25,4)	0.187 (4,8)
8104-0108-40	1.000 (25,4)	0.250 (6,4)
8104-0109-40	1.000 (25,4)	0.375 (9,5)

ULTRAFLEX D WITH PSA

Laird Technologies Part No.	Width	Height
8102-0202-40	0.200 (5,1)	0.130 (3,3)
8102-0209-40	0.250 (6,4)	0.125 (3,2)
8102-0203-40	0.250 (6,4)	0.190 (4,8)
8102-0204-40	0.312 (7,9)	0.250 (6,4)
8102-0205-40	0.380 (9,7)	0.312 (7,9)
8102-0206-40	0.500 (12,7)	0.375 (9,5)
8102-0207-40	0.750 (19,1)	0.670 (17,0)

For other platings, replace the suffix "40" as follows: **41**-Tin plate; **47**-Nickel plate; **48**-Cadmium plate; **49**-Zinc clear chromate. Other platings available upon request.

All dimensions shown are in inches (millimeters) unless otherwise specified.

* For part number ordering information on pressure-sensitive adhesive tape see page 1.4.



Compression Recovery

An important feature of UltraFlex® shielding gaskets is their capability to recover 90% or more of their free height after repeated deflections of up to 75% of free height.

Table 1 indicates cycle recovery data for standard UltraFlex diameters

TABLE 1. ULTRAFLEX COMPRESSION CYCLE TEST RECOVERY DATA

Laird Technologies Part No.*	% of Deflection	Recovery % After Cycle		
		100 Cycles	250 Cycles	500 Cycles
8101-0101-40	25	100	98	98
	50	98	98	94
	75	98	98	94
8101-0102-40	25	100	100	100
	50	98	98	96
	75	92	90	88
8101-0103-40	25	96	96	96
	50	96	96	96
	75	96	95	95
8101-0104-40	25	98	98	98
	50	98	98	98
	75	89	88	88
8101-0105-40	25	100	100	100
	50	100	98	98
	75	97	96	96
8101-0106-40	25	100	100	100
	50	100	100	99
	75	100	100	98
8101-0107-40	25	98	98	98
	50	98	98	97
	75	95	95	95
8101-0108-40	25	100	100	100
	50	100	99	99
	75	100	100	98
8101-0109-40	25	100	100	100
	50	98	98	97
	75	98	98	97

* For part number ordering information on pressure-sensitive adhesive tape see page 1.4.

Fabricated UltraFlex Gaskets

The UltraFlex products featured in this section can be supplied in bulk form on spools, or as individual gaskets fabricated to user specifications.

Shown below are diagrams of conventional O-ring and cut-to-length constructions.

FIGURE 1. O-RING CONSTRUCTION

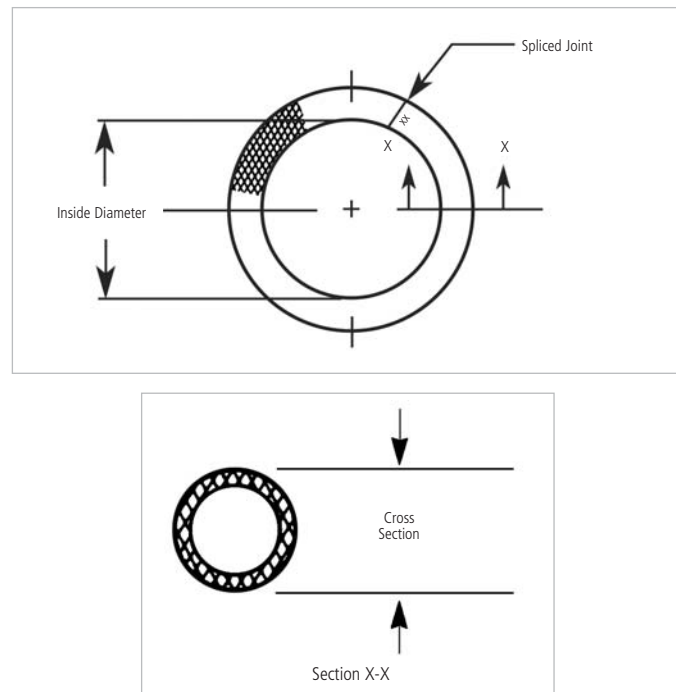
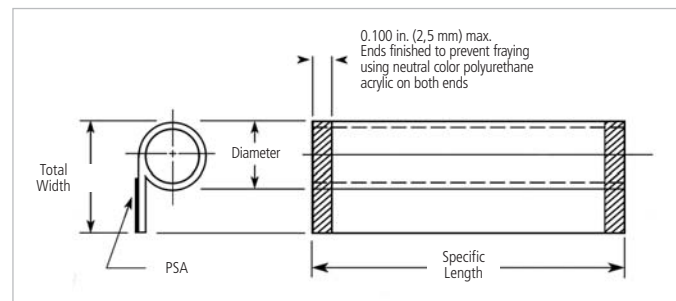

FIGURE 2. CUT-TO-LENGTH CONSTRUCTION HOLLOW CORE WITH FIN AND PSA TAPE



All dimensions shown are in inches (millimeters) unless otherwise specified.



www.atd-elektronik.cz
www.atd-shop.com



Laird Technologies ElectroNit® All Mesh EMI Gasketing has been designed to offer the highest possible levels of attenuation. Knit construction enhances long lasting resiliency, making it an ideal material for highly sensitive components in permanent or semi-permanent enclosures where environmental sealing is not a concern.

- Highest attenuation characteristics
- Available in beryllium copper, Monel®, tin plated copper clad steel, aluminum and stainless steel
- Versatile mounting
- Consistent point-to-point contact for high shielding effectiveness over life of gasket

ElectroNit All Mesh EMI Gasketing is supplied on spools in 25 ft. (7.6 m) minimum lengths. It is available in various alloys. To specify material type, select the material code number from Table 1 and insert the two-digit number in place of XX.

TABLE 1. MATERIAL SPECIFICATIONS

Material Code	Wire Type	Specification
40	Beryllium Copper	ASTM B 197
42	Monel®	QQ N 281 Class A
43	Aluminum	5056 Alloy
44	Tin Plated Copper Clad Steel	ASTM B 520
46	Stainless Steel Alloy	SS304

SHIELDING EFFECTIVENESS

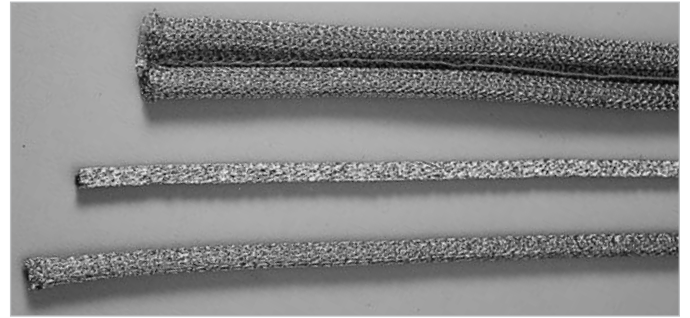
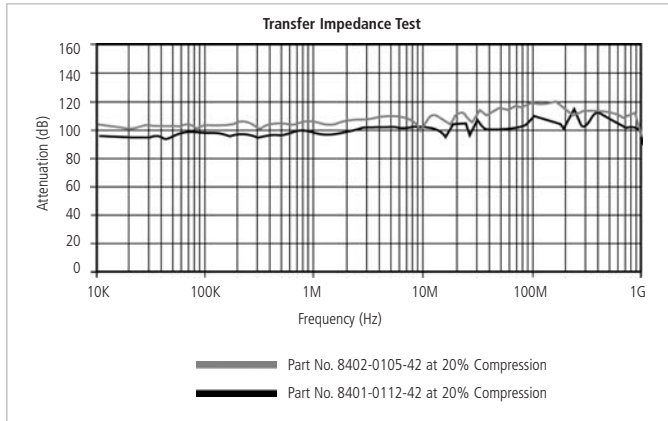

ElectroNit All Mesh Gasketing is available in a wide range of sizes in round or rectangular cross sections, as well as round with fin, and double round configurations.

Compression-Deflection

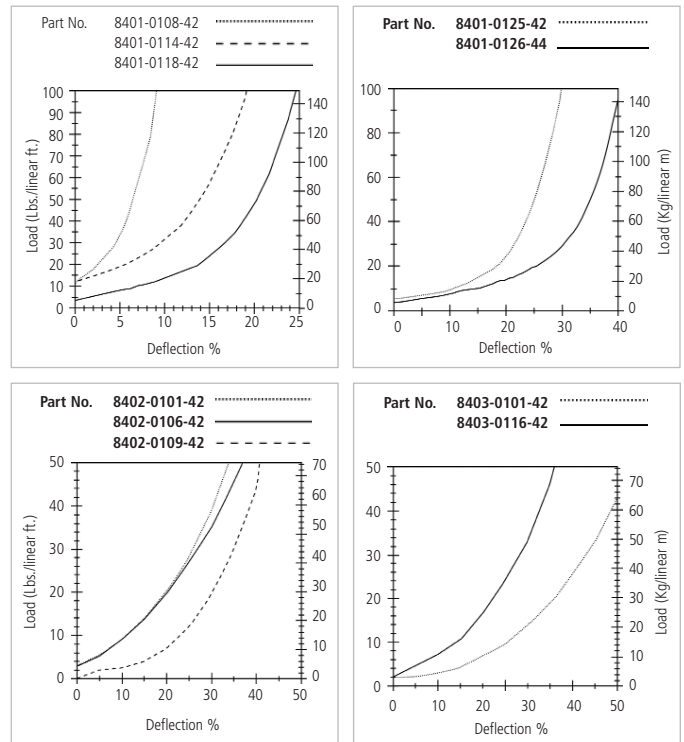



SIZE VS. TOLERANCE: ALL MESH SINGLE ROUND WITH FIN STRIP

Size Range	Tolerance	
	Dim W	Dim H
0.130 to 0.380 (3,3 to 9,7)	+ 0.060/- 0.030 (+1,5/-0,8)	+ 0.030/- 0.030 (+0,8/-0,8)
0.390 to 0.050 (9,9 to 12,7)	+ 0.060/- 0.060 (+1,5/-1,5)	+ 0.040/- 0.030 (+1,2/-0,8)
0.510 to 1.000 (13,0 to 25,4)	+ 0.090/- 0.060 (+2,3/-1,5)	+ 0.062/- 0.040 (+1,6/-1,0)

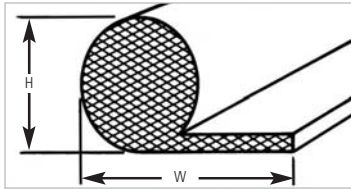

SIZE VS. TOLERANCE: ALL MESH DOUBLE ROUND WITH FIN STRIP

Size Range	Tolerance	
	Dim W	Dim H
To 0.180 (4,6)	N/A	+ 0.020/- 0.000 (+0,5/-0,0)
0.190 to 0.380 (4,8 to 9,7)	+ 0.060/- 0.030 (+1,5/-0,8)	+ 0.030/- 0.030 (+0,8/-0,8)
0.390 to 0.050 (9,9 to 12,7)	+ 0.060/- 0.060 (+1,5/-1,5)	+ 0.040/- 0.030 (+1,2/-0,8)
0.510 to 1.000 (13,0 to 25,4)	+ 0.090/- 0.060 (+2,3/-1,5)	+ 0.062/- 0.040 (+1,6/-1,0)

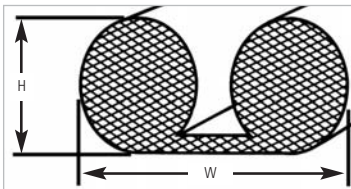

SIZE VS. TOLERANCE: ALL MESH RECTANGULAR STRIP

Size Range	Tolerance	
	Dim W	Dim H
To 0.180 (4,6)	+ 0.020/- 0.000 (+0,5/-0,0)	+ 0.020/- 0.000 (+0,5/-0,0)
0.190 to 0.380 (4,8 to 9,7)	+ 0.030/- 0.000 (+0,8/-0,0)	+ 0.030/- 0.000 (+0,8/-0,0)
0.390 to 0.050 (9,9 to 12,7)	+ 0.046/- 0.000 (+1,2/-0,0)	+ 0.046/- 0.000 (+1,2/-0,0)
0.510 to 1.000 (13,0 to 25,4)	+ 0.062/- 0.000 (+1,6/-0,0)	+ 0.062/- 0.000 (+1,6/-0,0)

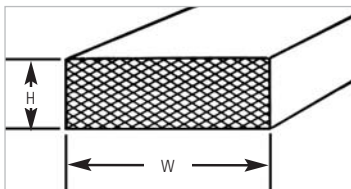

SIZE VS. TOLERANCE: ALL MESH ROUND STRIP

Size Range	Tolerance Diameter
	To 0.120 (3,1)
0.130 to 0.380 (3,3 to 9,7)	+ 0.030/- 0.000 (+0,8/-0,0)
0.390 to 0.050 (9,9 to 12,7)	+ 0.046/- 0.000 (+1,2/-0,0)
0.510 to 1.000 (13,0 to 25,4)	+ 0.062/- 0.000 (+1,6/-0,0)

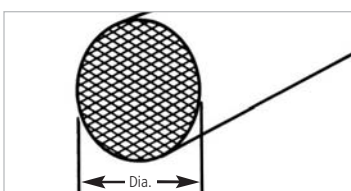

For Size vs. Tolerance charts, dimensions measured under 4 oz. load (11,3 gms) with 0.750 dia. (19,1 mm) anvil.

ALL MESH SINGLE ROUND WITH FIN STRIP

Base Part No.*	Fin Portion Width	Round Portion Height	Base Part No.*	Fin Portion Width	Round Portion Height
8403-0101-XX	0.375 (9,5)	0.062 (1,8)	8403-0121-XX	0.750 (19,1)	0.187 (4,8)
8403-0104-XX	0.375 (9,5)	0.125 (3,2)	8403-0110-XX	0.750 (19,1)	0.250 (6,4)
8403-0102-XX	0.500 (12,7)	0.062 (1,8)	8403-0113-XX	0.875 (22,2)	0.312 (7,9)
8403-0103-XX	0.500 (12,7)	0.093 (2,4)	8403-0111-XX	1.000 (25,4)	0.250 (6,4)
8403-0107-XX	0.500 (12,7)	0.156 (4,0)	8403-0114-XX	1.000 (25,4)	0.375 (9,5)
8403-0109-XX	0.500 (12,7)	0.250 (6,4)	8403-0115-XX	1.000 (25,4)	0.437 (11,1)
8403-0105-XX	0.625 (15,9)	0.125 (3,2)	8403-0116-XX	1.000 (25,4)	0.500 (12,7)
8403-0108-XX	0.625 (15,9)	0.187 (4,8)	8403-0131-XX	1.500 (38,1)	0.375 (9,5)
8403-0112-XX	0.625 (15,9)	0.312 (7,9)	8403-0125-XX	1.500 (38,1)	0.500 (12,7)
8403-0106-XX	0.750 (19,1)	0.125 (3,2)			

ALL MESH DOUBLE ROUND WITH FIN STRIP

Base Part No.*	Connecting Width	Round Height
8404-0101-XX	0.500 (12,7)	0.062 (1,6)
8404-0102-XX	0.500 (12,7)	0.125 (3,2)
8404-0105-XX	0.625 (15,9)	0.187 (4,8)
8404-0103-XX	0.750 (19,1)	0.125 (3,2)
8404-0107-XX	0.750 (19,1)	0.250 (6,4)
8404-0104-XX	1.000 (25,4)	0.125 (3,2)
8404-0106-XX	1.000 (25,4)	0.187 (4,8)
8404-0108-XX	1.000 (25,4)	0.250 (6,4)
8404-0109-XX	1.000 (25,4)	0.375 (9,5)
8404-0115-XX	1.250 (31,8)	0.250 (6,4)
8404-0124-XX	1.500 (38,1)	0.375 (9,5)
8404-0120-XX	1.500 (38,1)	0.500 (12,7)
8404-0121-XX	2.000 (50,8)	0.375 (9,5)
8404-0118-XX	2.000 (50,8)	0.500 (12,7)
8404-0122-XX	2.500 (63,5)	0.500 (12,7)

ALL MESH RECTANGULAR STRIP

Base Part No.*	Width W	Height H	Base Part No.*	Width W	Height H
8401-0101-XX	0.062 (1,8)	0.062 (1,6)	8401-0123-XX	0.250 (6,4)	0.250 (6,4)
8401-0134-XX	0.093 (2,4)	0.062 (1,8)	8401-0104-XX	0.312 (7,9)	0.062 (1,6)
8401-0107-XX	0.093 (2,4)	0.093 (2,4)	8401-0115-XX	0.312 (7,9)	0.125 (3,2)
8401-0102-XX	0.125 (3,2)	0.062 (1,6)	8401-0122-XX	0.312 (7,9)	0.187 (4,8)
8401-0108-XX	0.125 (3,2)	0.093 (2,4)	8401-0124-XX	0.312 (7,9)	0.250 (6,4)
8401-0112-XX	0.125 (3,2)	0.125 (3,2)	8401-0105-XX	0.375 (9,5)	0.062 (1,6)
8401-0137-XX	0.156 (4,0)	0.062 (1,8)	8401-0111-XX	0.375 (9,5)	0.093 (2,4)
8401-0129-XX	0.156 (4,0)	0.125 (3,2)	8401-0116-XX	0.375 (9,5)	0.125 (3,2)
8401-0142-XX	0.156 (4,0)	0.156 (4,0)	8401-0125-XX	0.375 (9,5)	0.250 (6,4)
8401-0103-XX	0.187 (4,8)	0.062 (1,6)	8401-0127-XX	0.375 (9,5)	0.375 (9,5)
8401-0109-XX	0.187 (4,8)	0.093 (2,4)	8401-0106-XX	0.500 (12,7)	0.062 (1,6)
8401-0113-XX	0.187 (4,8)	0.125 (3,2)	8401-0117-XX	0.500 (12,7)	0.125 (3,2)
8401-0120-XX	0.187 (4,8)	0.187 (4,8)	8401-0133-XX	0.500 (12,7)	0.187 (4,8)
8401-0131-XX	0.218 (5,5)	0.156 (4,0)	8401-0126-XX	0.500 (12,7)	0.250 (6,4)
8401-0155-XX	0.250 (6,4)	0.062 (1,8)	8401-0118-XX	0.750 (19,1)	0.125 (3,2)
8401-0110-XX	0.250 (6,4)	0.093 (2,4)	8401-144-XX	0.750 (19,1)	0.187 (4,8)
8401-0114-XX	0.250 (6,4)	0.125 (3,2)	8401-0119-XX	1.000 (25,4)	0.125 (3,2)
8401-0121-XX	0.250 (6,4)	0.187 (4,8)			

ALL MESH ROUND STRIP

Base Part No.	Diameter	Base Part No.	Diameter
8402-0101-XX	0.062 (1,6)	8402-0106-XX	0.250 (6,4)
8402-0102-XX	0.093 (2,4)	8402-0107-XX	0.312 (7,9)
8402-0103-XX	0.125 (3,2)	8402-0108-XX	0.375 (9,5)
8402-0104-XX	0.156 (4,0)	8402-0109-XX	0.500 (12,7)
8402-0105-XX	0.187 (4,8)		

* For part number ordering information on pressure-sensitive adhesive tape see page 1.4.

All dimensions shown are in inches (millimeters) unless otherwise specified.



Fabricated All Mesh Gaskets

Laird Technologies can supply fabricated gaskets, specified from the products highlighted in this section, to meet a vast range of custom assembly requirements.

Shown below are guidelines for three standard construction configurations.

FIGURE 1. SINGLE FIN RECTANGULAR CONSTRUCTION

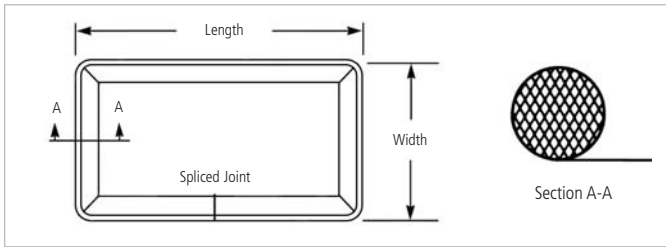

TOLERANCE

Size Range	Tolerance
2.0 to 6.0 (50,8 to 152,4)	± 0.030 (0,8)
6.0 to 12.0 (152,4 to 304,8)	± 0.046 (1,2)
12.0 to 18.0 (304,8 to 457,2)	± 0.062 (1,6)
18.0 to 24.0 (457,2 to 609,6)	± 0.093 (2,4)

FIGURE 2. O-RING CONSTRUCTION

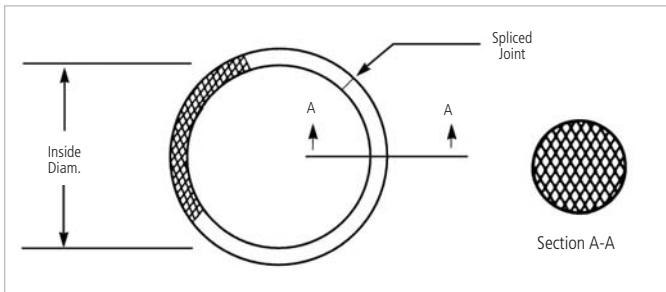

TOLERANCE

Size Range	Tolerance
2.0 to 4.0 (50,8 to 101,6)	± 0.020 (0,5)
4.0 to 8.0 (101,6 to 203,2)	± 0.030 (0,8)
8.0 to 12.0 (203,2 to 304,8)	± 0.046 (1,2)
12.0 to 18.0 (304,8 to 457,2)	± 0.062 (1,6)

FIGURE 3. CUT-TO-LENGTH RECTANGULAR

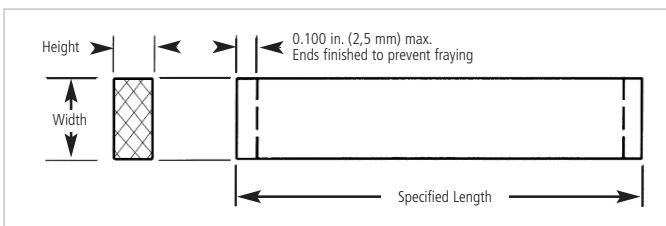

TOLERANCE

Size Range	Tolerance
1.0 to 4.0 (25,4 to 101,6)	± 0.030 (0,8)
4.0 to 8.0 (101,6 to 203,2)	± 0.060 (1,5)
8.0 to 12.0 (203,2 to 304,8)	± 0.093 (2,4)
12.0 to 18.0 (304,8 to 457,2)	± 0.125 (3,2)

All dimensions shown are in inches (millimeters) unless otherwise specified.





Laird Technologies ElectroNit® Enviro-Seal™ gasketing with neoprene or silicone elastomer is specially designed to combine outstanding attenuation characteristics with climatic and thermal protection for electronic enclosures.

- Effectiveness against severe temperature variations from -103°F to 500°F (-75°C to 260°C)
- Protection against dust, dirt and moisture
- Adhesive backing for ease of installation
- Shielding material selection including beryllium copper, Monel and tin-plated copper clad steel
- Other alloys available upon request

Enviro-Seal gasketing is supplied coiled in multiples of 50 ft. (15,2 m) and is available with either silicone or neoprene sealing strips in either beryllium copper, Monel, or tin plated copper clad steel.

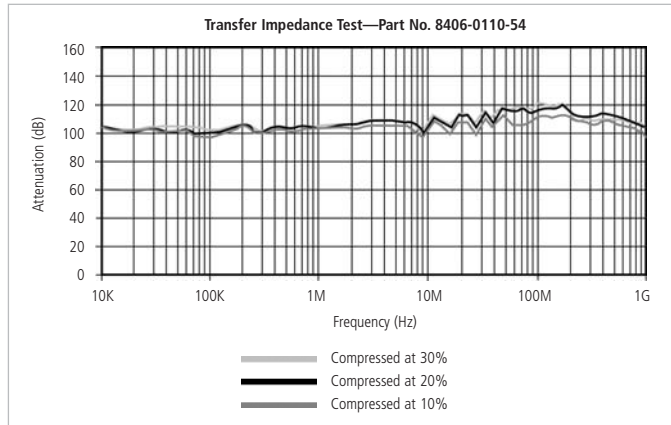

TABLE 1. MATERIAL SPECIFICATIONS

Wire Type	Description	Specification
Wire Type	Beryllium Copper	ASTM B 197
	Monel®	QQ N 281 Class A
	Tin Plated Copper Clad Steel	ASTM B 520
Elastomer Type	Neoprene Sponge	MIL-R-6130 Type II, Grade A (Closed Cell) Conditioned Medium; Temp. Range -24°F to 212°F (-31°C to 100°C)
	Silicone Sponge	AMS 3195 (Closed Cell); Temp. Range -103°F to 400°F (-75°C to 204°C)
	Silicone Solid	ZZ-R-765, Class 2, Grade 50; Temp. Range -80°F to 500°F (-62°C to 260°C)

▲ Enviro-Seal gasketing is available in a wide range of sizes, with either silicone or neoprene environmental seal.

SHIELDING EFFECTIVENESS



COMPRESSION-DEFLECTION

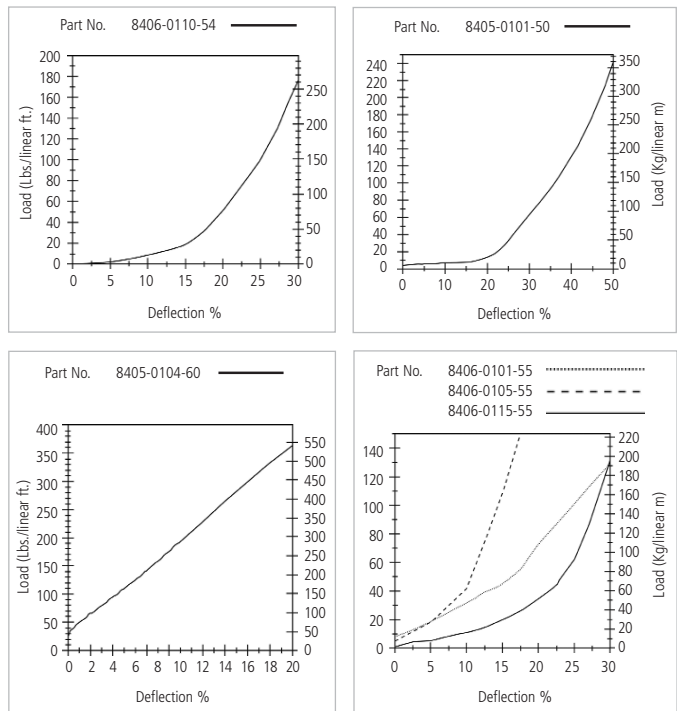



SIZE VS. TOLERANCE

Size Range	Tolerance				
	A		B		C&D
	Sponge	Solid	Sponge	Solid	
To 0.180 (4,6)	+ 0.030/- 0.020 (+ 0,8/-0,5)	± 0.020 (±0,5)	± 0.030 (±0,8)	± 0.030 (±0,8)	+ 0.020/- 0.000 (+0,5/- 0,0)
0.190 to 0.380 (4,8 to 9,7)	± 0.030 (± 0,8)	± 0.030 (± 0,8)	± 0.030 (±0,8)	± 0.030 (±0,8)	+ 0.030/- 0.000 (+0,8/- 0,0)
0.390 to 0.050 (9,9 to 12, 7)	± 0.046 (± 1,2)	+ 0.040/- 0.030 (+1,0/-0,8)	± 0.030 (±0,8)	± 0.030 (±0,8)	+ 0.046/- 0.000 (+1,2/- 0,0)
0.510 to 1.000 (13,0 to 25,4)	± 0.062 (± 1,6)	+ 0.060/- 0.040 (+1,5/-1,0)	± 0.060 (±1,5)	± 0.060 (±1,5)	+ 0.062/- 0.000 (+1,6/- 0,0)

For Size vs. Tolerance charts, dimensions measured under 4 oz. load (11,3 gms) with 0.750 dia. (19,1 mm) anvil.

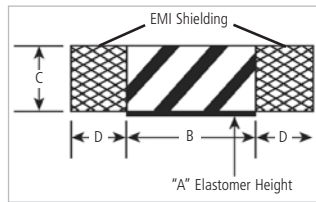
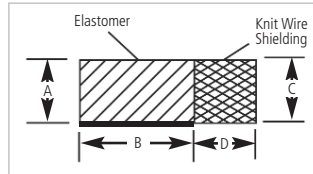

Application Design Data

Enviro-Seal gaskets are used in applications which require both moisture and dust sealing and EMI shielding. Presented in this section is a guide to several mounting methods, compression stop applications, and fabricated gaskets.

Mounting Methods

Figures 1a and 1b show two common methods used to mount Enviro-Seal gaskets.

ENVIRO-SEAL STRIPS WITH PRESSURE-SENSITIVE ADHESIVE (PSA)

Laird Technologies Part No.	Dimensions			
	A	B	C	D
8406-0101-50	0.062 (1,6)	0.250 (6,4)	0.062 (1,6)	0.125 (3,2)
8406-0102-50	0.062 (1,6)	0.375 (9,5)	0.062 (1,6)	0.125 (3,2)
8406-0103-50	0.093 (2,4)	0.375 (9,5)	0.093 (2,4)	0.125 (3,2)
8406-0104-50	0.093 (2,4)	0.500 (12,7)	0.093 (2,4)	0.125 (3,2)
8406-0105-50	0.125 (3,2)	0.125 (3,2)	0.125 (3,2)	0.125 (3,2)
8406-0106-50	0.125 (3,2)	0.188 (4,8)	0.125 (3,2)	0.188 (4,8)
8406-0107-50	0.125 (3,2)	0.250 (6,4)	0.125 (3,2)	0.125 (3,2)
8406-0108-50	0.125 (3,2)	0.250 (6,4)	0.125 (3,2)	0.250 (6,4)
8406-0109-50	0.125 (3,2)	0.375 (9,5)	0.125 (3,2)	0.125 (3,2)
8406-0110-50	0.125 (3,2)	0.625 (15,9)	0.125 (3,2)	0.125 (3,2)
8406-0111-50	0.188 (4,8)	0.188 (4,8)	0.188 (4,8)	0.125 (3,2)
8406-0112-50	0.188 (4,8)	0.250 (6,4)	0.188 (4,8)	0.125 (3,2)
8406-0113-50	0.188 (4,8)	0.500 (12,7)	0.188 (4,8)	0.125 (3,2)
8406-0114-50	0.250 (6,4)	0.250 (6,4)	0.250 (6,4)	0.125 (3,2)
8406-0131-50	0.250 (6,4)	0.380 (9,7)	0.250 (6,4)	0.125 (3,2)
8406-0115-50	0.250 (6,4)	0.500 (12,7)	0.250 (6,4)	0.125 (3,2)
8406-0116-50	0.375 (9,5)	0.500 (12,7)	0.375 (9,5)	0.250 (6,4)
8406-0120-50	0.375 (9,5)	0.750 (19,1)	0.375 (9,5)	0.250 (6,4)

The suffix "50" is BeCu neoprene sponge. For other materials, replace the suffix "50" as follows: **54**-Neoprene sponge and Monel; **52**-Silicone sponge and beryllium copper; **55**-Silicone sponge and Monel; **60**-Neoprene sponge and tin plated copper clad steel; **61**-Silicone sponge and tin plated copper clad steel.

ENVIRO-SEAL DOUBLE SHIELD STRIPS WITH PRESSURE-SENSITIVE ADHESIVE (PSA)

Laird Technologies Part No.	Dimensions			
	A	B	C	D
8405-0101-50	0.125 (3,2)	0.250 (6,4)	0.125 (3,2)	0.125 (3,2)
8405-0102-50	0.125 (3,2)	0.375 (9,5)	0.125 (3,2)	0.125 (3,2)
8405-0103-50	0.125 (3,2)	0.500 (12,7)	0.125 (3,2)	0.125 (3,2)
8405-0104-50	0.188 (4,8)	0.500 (12,7)	0.188 (4,8)	0.125 (3,2)

The suffix "50" is BeCu neoprene sponge. For other materials, replace the suffix "50" as follows: **54**-Neoprene sponge and Monel; **52**-Silicone sponge and beryllium copper; **55**-Silicone sponge and Monel; **60**-Neoprene sponge and tin plated copper clad steel; **61**-Silicone sponge and tin plated copper clad steel.

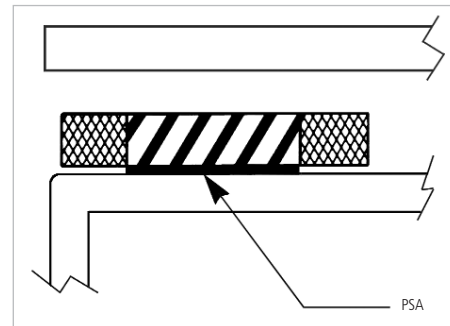

Figure 1a.
Double Shield Strip
with PSA

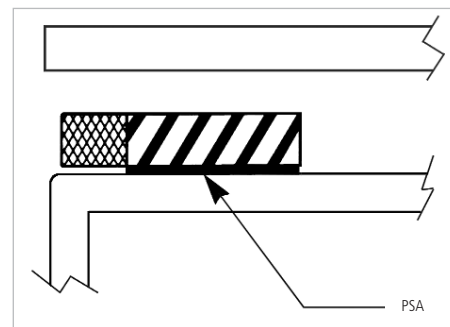

Figure 1b.
Enviro-Seal Strip
with PSA



www.atd-elektronik.cz
www.atd-shop.com

All dimensions shown are in inches (millimeters) unless otherwise specified.



Fabricated Enviro-Seal Gaskets

Laird Technologies can supply fabricated gaskets to fit your enclosure size and mounting criteria. Figure 2 is a common Enviro-Seal construction with bolt and/or slotted hole design.

FIGURE 2. ENVIRO-SEAL GASKET

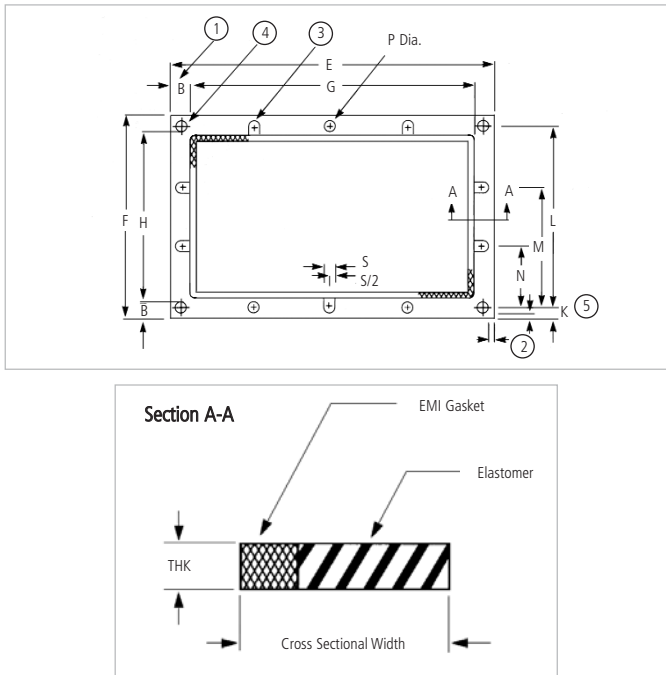

Notes:

1. Minimum sealing gasket width is 0.125 in. (3,2 mm) but not less than gasket thickness.
2. Minimum distance from bolt hole or compression stop to edge of sealing gasket is not less than thickness of elastomer material.
3. If bolt holes must be closer than stated in Note 2, use U-shaped slots.
4. Minimum hole diameter not less than elastomer thickness.
5. Datum.

TOLERANCE

Dimensional Location	Size Range with Tolerance		
	0 to 4 (0 to 101,6)	4.1 to 12.0 (104,1 to 304,8)	12.1 to 24.0 (307,3 to 609,6)
F, H, E, G	Length & Width ± 0.020 (+0,5)	± 0.031 (+0,8)	± 0.040 (+1,0)
K, N, M, L	Hole Location ± 0.010 (+0,3)	± 0.015 (+0,4)	± 0.020 (+0,5)

All dimensions shown are in inches (millimeters) unless otherwise specified.

Compression Stops

In order to avoid over-compressing the gasket or excessive bowing of the cover plate from gasket overcompression, disc or washer type compression stops can be provided as part of the gasket assembly. Compression stops are either fabricated from sheet, rod, or tubing material. Most commonly used are aluminum and stainless steel material.

Typical compression stop assemblies are shown in Figures 3a and 3b.

FIGURE 3A. DISC TYPE COMPRESSION STOP

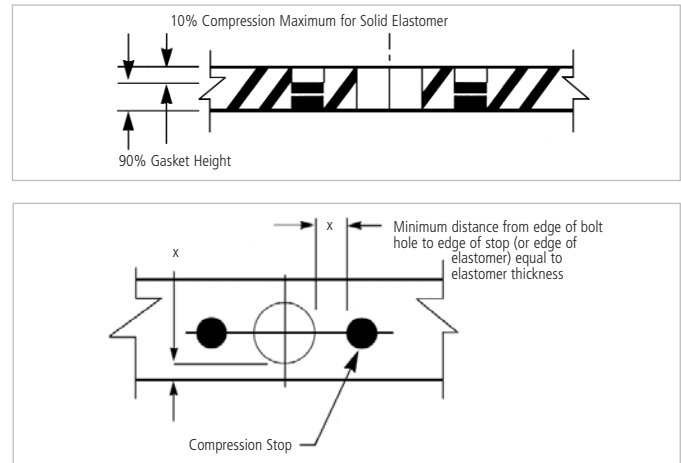
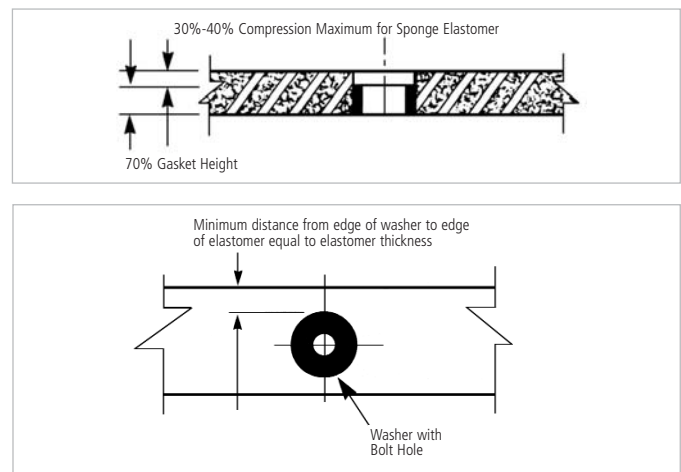

FIGURE 3B. WASHER TYPE COMPRESSION STOP





Laird Technologies ElectroNit® Super Soft gasket material consist of one layer of knitted wire mesh over a flame retardent UL 94 HF-1 low density foam polyester core material. Two wires in three different diameters are available. Please refer to table Material Code on this page.

Rectangular Standard Profile

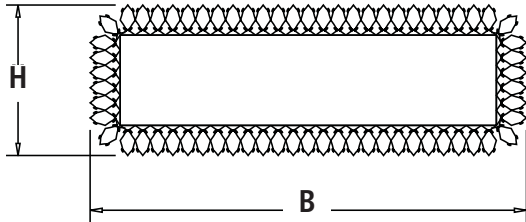

PU-foam with 1 layer only

Part Number	H	B
-2207	0.126 (3,2)	0.252 (6,4)
-2208	0.126 (3,2)	0.374 (9,5)
-2209	0.126 (3,2)	0.500 (12,7)
-2210	0.189 (4,8)	0.189 (4,8)
-2211	0.189 (4,8)	0.252 (6,4)
-2212	0.189 (4,8)	0.374 (9,5)
-2213	0.252 (6,4)	0.252 (6,4)
-2214	0.252 (6,4)	0.374 (9,5)
-2215	0.252 (6,4)	0.500 (12,7)

Other dimensions on request

Ordering Information

The ordering code consists of the material code, followed by the part number for dimensions: XXXX-XXXX-1



If adhesive tape is required, please check possibility with customer service. For adhesive tape add "-1_" to the end of the order code.

All dimensions shown are in inches (millimeters) unless otherwise specified.



Material Code

Elastomer	Mesh			
	Monel®	Alu	Stainless steel	Tin plated copper clad steel
PU-Foam 0.004 inch wire (0,1 mm)	8437-	-	8433-	8438-
PU-Foam 0.002 inch wire (0,05 mm)	8439-	-	-	-

Specifications

Elastomer	Standard	Compression in(mm)	Cell Type	Density kg/m³	Temperature	Color
PU-Foam HF-1	-	0.1- 0.15 (2,6 - 3,8)	Open	28-32	-40° to 110°C	dark gray

Mechanical Tolerance

Mesh Dimensions	
0.079 - 0.197 in: 2- 5 mm:	+0.016 - 0.0 in +0,4 - 0,0 mm
> 0.197 - 0.394 in: > 2- 5 mm:	+0.020 - 0.012 in +0,5 - 0,3 mm
> 0.394 in: > 10 mm:	+0.059 - 0.020 in +1,5 - 0,5 mm
0.590 in: > 15 mm:	+/- 0.079 in +/- 2 mm



www.atd-elektronik.cz
www.atd-shop.com



Laird Technologies ElectroNit® elastomer core offers low compression requirements and low compression set. It is available with a wide range of elastomer core materials and configurations, and a full selection of knitted mesh shielding covers. Combined, they mean greater system design efficiency with the attenuation levels you require.

Specified with beryllium copper knitted mesh, the gaskets provide as much as 20 dB greater attenuation than with conventional mesh shielding materials. Other available materials include Monel® and tin plated copper clad steel.

- High resiliency
- Low compression force requirements
- Groove or fin mounting

ElectroNit elastomer core EMI gasketing is available in round or rectangular configurations, with hollow or solid core, in sponge elastomer or solid silicone. It is available with beryllium copper, Monel®, or tin-plated copper clad steel, and is supplied on spools in 25 ft. (7,6 m) minimum lengths.

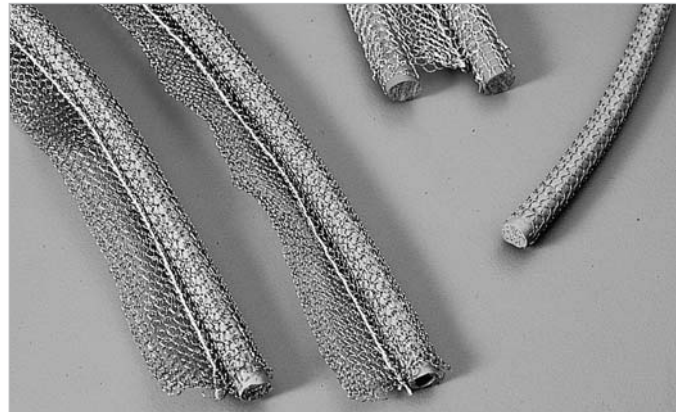
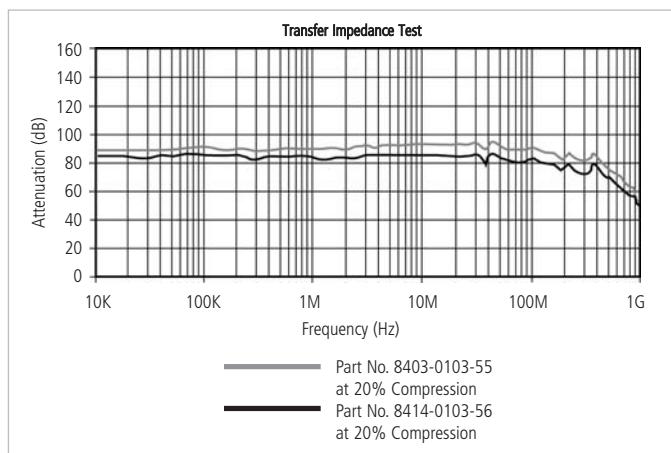

TABLE 1. MATERIAL SPECIFICATIONS

Wire Type	Description	Specification
Wire Type	Beryllium Copper	ASTM B 197
	Monel®	QQ N 281 Class A
	Tin Plated Copper Clad Steel	ASTM B 520
Elastomer Type	Neoprene Sponge	MIL-R-6130 Type II, Grade A (Closed Cell) Conditioned Medium; Temp. Range -24°F to 212°F (-31,1°C to 100°C)
	Silicone Sponge	AMS 3195 (Closed Cell); Temp. Range -103°F to 400°F (-75°C to 204°C)
	Silicone Solid	ZZ-R-765, Class 2, Grade 50; Temp. Range -80°F to 500°F (-62,2°C to 260°C)

Shielding Effectiveness



COMPRESSION-DEFLECTION

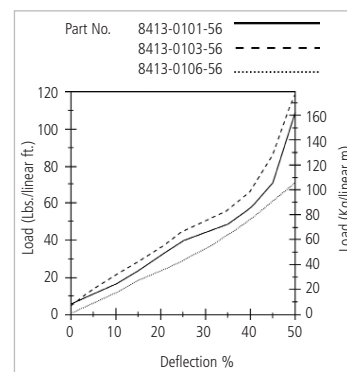
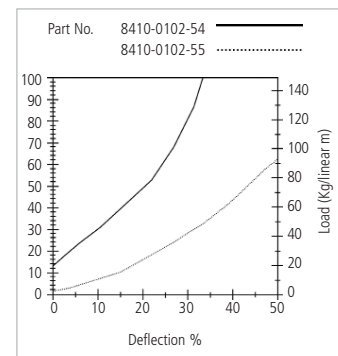
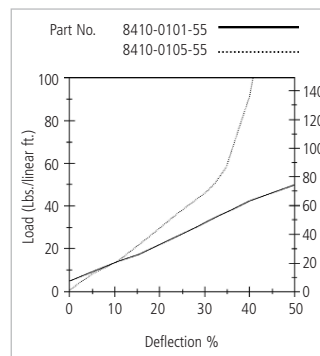
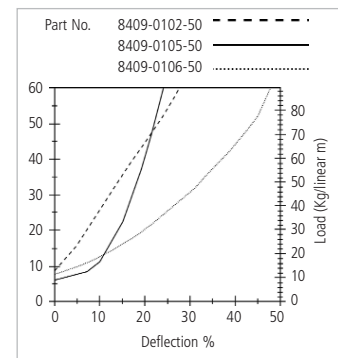
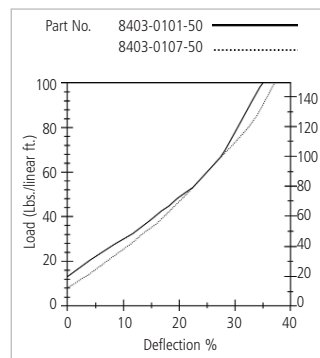

All dimensions shown are in inches (millimeters) unless otherwise specified.

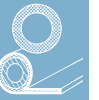

SIZE VS. TOLERANCE: RECTANGULAR WITH SPONGE ELASTOMER

Size Range	Tolerance	
	Width	Height
To 0.120 (3,1)	+ 0.030/- 0.020 (+0,8/-0,5)	+ 0.030/- 0.020 (+0,8/-0,5)
0.130 to 0.380 (3,3 to 9,7)	± 0.030 (±0,8)	+ 0.030 (±0,8)
0.390 to 0.050 (9,9 to 12,7)	± 0.046 (±1,2)	± 0.046 (±1,2)
0.510 to 1.000 (13,0 to 25,4)	± 0.062 (±1,6)	+ 0.062 (±1,6)

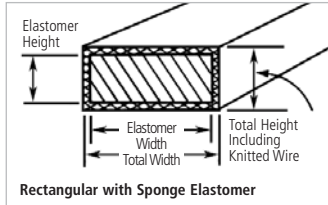

RECTANGULAR WITH SPONGE ELASTOMER

Laird Technologies Part No.*	Elastomer Width	Elastomer Height	Total Width	Total Height
8409-0101-50	0.125 (3,2)	0.125 (3,2)	0.160 (4,1)	0.160 (4,1)
8409-0102-50	0.188 (4,8)	0.125 (3,2)	0.225 (5,7)	0.160 (4,1)
8409-0104-50	0.188 (4,8)	0.188 (4,8)	0.225 (5,7)	0.225 (5,7)
8409-0130-50	0.250 (6,4)	0.062 (1,6)	0.270 (6,9)	0.082 (2,1)
8409-0103-50	0.250 (6,4)	0.125 (3,2)	0.285 (7,2)	0.160 (4,1)
8409-0105-50	0.250 (6,4)	0.250 (6,4)	0.285 (7,2)	0.285 (7,2)
8409-0125-50	0.375 (9,5)	0.125 (3,2)	0.410 (10,4)	0.160 (4,1)
8409-0166-50	0.375 (9,5)	0.250 (6,4)	0.410 (10,4)	0.285 (7,2)
8409-0126-50	0.375 (9,5)	0.375 (9,5)	0.405 (10,3)	0.405 (10,3)
8409-0158-50	0.500 (12,7)	0.125 (3,2)	0.518 (13,2)	0.143 (3,6)
8409-0106-50	0.500 (12,7)	0.250 (6,4)	0.535 (13,6)	0.285 (7,2)
8409-0132-50	0.500 (12,7)	0.250 (6,4)	0.535 (13,6)	0.285 (7,2)
8409-0161-50	0.500 (12,7)	0.312 (7,9)	0.540 (13,7)	0.352 (8,9)
8409-0117-50	0.500 (12,7)	0.500 (12,7)	0.535 (13,6)	0.535 (13,6)
8409-0176-50	0.750 (19,1)	0.250 (6,4)	0.785 (19,9)	0.285 (7,2)
8409-0168-50	1.000 (25,4)	0.250 (6,4)	1.035 (26,3)	0.285 (7,2)
8409-0173-50	1.250 (31,8)	0.500 (12,7)	1.272 (32,3)	0.567 (14,4)

The suffix "50" is BeCu neoprene sponge. For other materials, replace the suffix "50" as follows: **54**-Neoprene sponge and Monel; **52**-Silicone sponge and beryllium copper; **55**-Silicone sponge and Monel; **60**-Neoprene sponge and tin plated copper clad steel; **61**-Silicone sponge and tin plated copper clad steel.

SIZE VS. TOLERANCE: ROUND WITH SPONGE AND SILICONE

Size Range	Tolerance	
	O.D.	
To 0.120 (3,1)	± 0.020 (±0,5)	
0.130 to 0.380 (3,3 to 9,7)	± 0.030 (±0,8)	
0.390 to 0.050 (9,9 to 12,7)	+ 0.040/-0.030 (+1,0/-0,8)	
0.510 to 1.000 (13,0 to 25,4)	+ 0.062/-0.040 (+1,6/-1,0)	

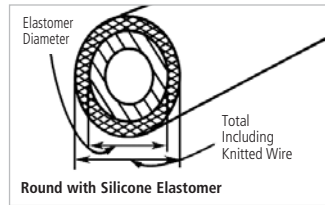
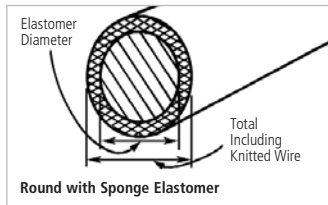

ROUND WITH SPONGE ELASTOMER

Laird Technologies Part No.	Elastomer Diameter	Total Diameter Over Wire
8410-0101-50**	0.062 (1,6)	0.098 (2,5)
8410-0102-50	0.125 (3,2)	0.160 (4,1)
8410-0103-50	0.188 (4,8)	0.225 (5,7)
8410-0104-50	0.250 (6,4)	0.285 (7,2)
8410-0105-50	0.312 (7,9)	0.348 (8,8)
8410-0106-50	0.375 (9,5)	0.410 (10,4)
8410-0107-50	0.500 (12,7)	0.535 (13,6)

The suffix "50" is BeCu neoprene sponge. For other materials, replace the suffix "50" as follows: **54**-Neoprene sponge and Monel; **52**-Silicone sponge and beryllium copper; **55**-Silicone sponge and Monel; **60**-Neoprene sponge and tin plated copper clad steel; **61**-Silicone sponge and tin plated copper clad steel.

**Not available in Neoprene sponge.

ROUND WITH SILICONE ELASTOMER TUBING

Laird Technologies Tubing Part No.	Tubing Diameter (O.D.)	Diameter Over Wire
8413-0101-64	0.125 (3,2)	0.160 (4,1)
8413-0102-64	0.188 (4,8)	0.225 (5,7)
8413-0103-64	0.250 (6,4)	0.285 (7,2)
8413-0104-64	0.312 (7,9)	0.348 (8,8)
8413-0114-64	0.375 (9,5)	0.383 (9,7)
8413-0105-64	0.375 (9,5)	0.410 (10,4)
8413-0106-64	0.500 (12,7)	0.535 (13,6)

The suffix "64" is BeCu with silicone elastomer tubing. For other materials, replace the suffix "64" as follows: **56**-Silicone elastomer tubing with Monel; **65**-Silicone elastomer tubing with tin plated copper clad steel.

SIZE VS. TOLERANCE: SINGLE FIN WITH SPONGE ELASTOMER

Size Range	Tolerance	
	Width	Height
0.130 to 0.380 (3,3 to 9,7)	± 0.030 (±0,8)	+ 0.060/-0.030 (+1,5/-0,8)
0.390 to 0.050 (9,9 to 12,7)	+ 0.040/- 0.030 (+1,0/-0,8)	± 0.060 (±1,5)
0.510 to 1.000 (13,0 to 25,4)	+ 0.062/- 0.040 (+1,6/-1,0)	+ 0.090/-0.060 (+2,3/-1,5)

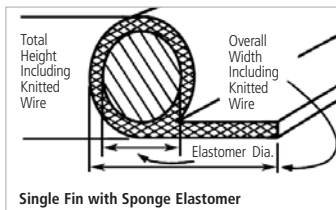

SINGLE FIN WITH SPONGE ELASTOMER

Laird Technologies Part No.*	Elastomer Diameter	Overall Width	Total Height
8403-0101-50	0.125 (3,2)	0.500 (12,7)	0.160 (4,1)
8403-0102-50	0.125 (3,2)	0.750 (19,1)	0.160 (4,1)
8403-0103-50	0.188 (4,8)	0.625 (15,9)	0.225 (5,7)
8403-0104-50	0.188 (4,8)	0.750 (19,1)	0.225 (5,7)
8403-0105-50	0.250 (6,4)	0.750 (19,1)	0.285 (7,2)
8403-0106-50	0.250 (6,4)	1.000 (25,4)	0.285 (7,2)
8403-0107-50	0.500 (12,7)	1.000 (25,4)	0.535 (13,6)

The suffix "50" is BeCu neoprene sponge. For other materials, replace the suffix "50" as follows: **54**-Neoprene sponge and Monel; **52**-Silicone sponge and beryllium copper; **55**-Silicone sponge and Monel; **60**-Neoprene sponge and tin plated copper clad steel; **61**-Silicone sponge and tin plated copper clad steel.

* For part number ordering information on pressure-sensitive adhesive tape see page 1.4.

All dimensions shown are in inches (millimeters) unless otherwise specified.



www.atd-elektronik.cz
www.atd-shop.com



SIZE VS. TOLERANCE: DOUBLE FIN WITH SPONGE ELASTOMER

Size Range	Tolerance	
	Width	Height
0.130 to 0.380 (3,3 to 9,7)	+ 0.030 (+0,8)	+ 0.060/- 0.030 (+1,5/-0,8)
0.390 to 0.050 (9,9 to 12,7)	+ 0.040/- 0.030 (+1,0/-0,8)	+ 0.060 (±1,5)
0.510 to 1.000 (13,0 to 25,4)	+ 0.062/- 0.040 (+1,6/-1,0)	+ 0.090/- 0.060 (+2,3/-1,5)

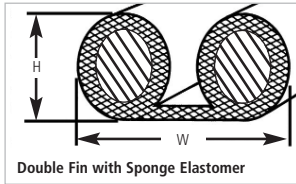

For Size vs. Tolerance charts, dimensions measured under 4 oz. load (11,3 gms) with 0.750 dia. (19,1 mm) anvil.

DOUBLE FIN WITH SPONGE ELASTOMER

Laird Technologies Part No.*	Elastomer Diameter	Overall Width	Total Height
8412-0101-50	0.125 (3,2)	0.500 (12,7)	0.160 (4,1)
8412-0102-50	0.125 (3,2)	0.750 (19,1)	0.160 (4,1)
8412-0103-50	0.188 (4,8)	0.625 (15,9)	0.225 (5,7)
8412-0104-50	0.188 (4,8)	0.750 (19,1)	0.225 (5,7)
8412-0105-50	0.250 (6,4)	1.000 (25,4)	0.285 (7,2)
8412-0106-50	.500 (12,7)	.312 (33,3)	.535 (13,6)

The suffix "50" is BeCu neoprene sponge. For other materials, replace the suffix "50" as follows: **54**-Neoprene sponge and Monel; **52**-Silicone sponge and beryllium copper; **55**-Silicone sponge and Monel; **60**- Neoprene sponge and tin plated copper clad steel; **61**-Silicone sponge and tin plated copper clad steel.

SIZE VS. TOLERANCE: SINGLE FIN WITH SILICONE ELASTOMER TUBING

Size Range	Tolerance	
	Width	Height
0.130 to 0.380 (3,3 to 9,7)	+ 0.030 (+0,8)	+ 0.060/- 0.030 (+1,5/-0,8)
0.390 to 0.050 (9,9 to 12,7)	+ 0.040/- 0.030 (+1,0/-0,8)	+ 0.060 (±1,5)
0.510 to 1.000 (13,0 to 25,4)	+ 0.062/- 0.040 (+1,6/-1,0)	+ 0.090/- 0.060 (+2,3/-1,5)

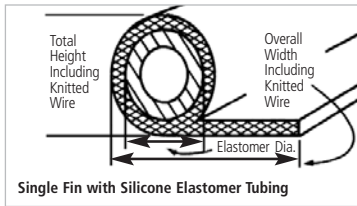

For Size vs. Tolerance charts, dimensions measured under 4 oz. load (11,3 gms) with 0.750 dia. (19,1 mm) anvil.

SINGLE FIN WITH SILICONE ELASTOMER TUBING

Laird Technologies Part No.*	Tubing Diameter (O.D.)	Overall Width	Total Height Over Wire
8414-0101-64	0.125 (3,2)	0.500 (12,7)	0.160 (4,1)
8414-0102-64		0.750 (19,1)	
8414-0103-64	0.188 (4,8)	0.625 (15,9)	0.225 (5,7)
8414-0104-64		0.750 (19,1)	
8414-0105-64	0.250 (6,6)	0.750 (19,1)	0.285 (7,2)
8414-0106-64		1.000 (25,4)	
8414-0107-64	0.312 (7,9)	0.625 (15,9)	0.348 (8,8)
8414-0108-64		1.000 (25,4)	
8414-0109-64	0.375 (9,5)	0.750 (19,1)	0.410 (10,4)
8414-0110-64		1.120 (28,5)	
8414-0111-64	0.500 (12,7)	1.000 (25,4)	0.535 (13,6)
8414-0112-64		1.250 (31,8)	

The suffix "64" is BeCu with silicone elastomer tubing. For other materials, replace the suffix "64" as follows: **56**-Silicone elastomer tubing with Monel; **65**-Silicone elastomer tubing with tin plated copper clad steel.

SIZE VS. TOLERANCE: DOUBLE FIN WITH SILICONE ELASTOMER TUBING

Size Range	Tolerance	
	Width	Height
0.130 to 0.380 (3,3 to 9,7)	+ 0.030 (+0,8)	+ 0.060/- 0.030 (+1,5/-0,8)
0.390 to 0.050 (9,9 to 12,7)	+ 0.040/- 0.030 (+1,0/-0,8)	+ 0.060 (±1,5)
0.510 to 1.000 (13,0 to 25,4)	+ 0.062/- 0.040 (+1,6/-1,0)	+ 0.090/- 0.060 (+2,3/-1,5)

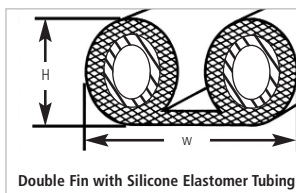

For Size vs. Tolerance charts, dimensions measured under 4 oz. load (11,3 gms) with 0.750 dia. (19,1 mm) anvil.

DOUBLE FIN WITH SILICONE ELASTOMER TUBING

Laird Technologies Part No.*	Tubing Diameter (O.D.)	Overall Width	Total Height Over Wire
8415-0101-64	0.125 (3,2)	0.500 (12,7)	0.160 (4,1)
8415-0102-64		0.750 (19,1)	
8415-0103-64	0.188 (4,8)	0.625 (15,9)	0.225 (5,7)
8415-0104-64		0.750 (19,1)	
8415-0105-64	0.250 (6,4)	0.750 (19,1)	0.285 (7,2)
8415-0106-64		1.000 (25,4)	
8415-0108-64	0.312 (7,9)	1.000 (25,4)	0.348 (8,8)
8415-0110-64	0.375 (9,5)	1.120 (28,5)	0.410 (10,4)
8415-0112-64	0.500 (12,7)	1.250 (31,8)	0.535 (13,6)

The suffix "64" is BeCu with silicone elastomer tubing. For other materials, replace the suffix "64" as follows: **56**-Silicone elastomer tubing with Monel; **65**-Silicone elastomer tubing with tin plated copper clad steel.

* For part number ordering information on pressure-sensitive adhesive tape see page 1.4.

All dimensions shown are in inches (millimeters) unless otherwise specified.



www.atd-elektronik.cz
www.atd-shop.com



FABRICATED ELASTOMER CORE GASKETS

The fabricated gaskets shown below can be provided to meet specific enclosure size and mounting criteria.

Figures 1 and 2 represent standard elastomer core construction. Please consult Laird Technologies engineering department at 1-800-843-4556 for elastomer core rectangular gaskets.

FIGURE 1. O-RING CONSTRUCTION

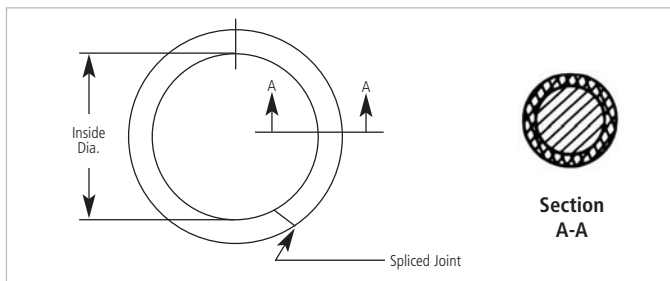

TOLERANCE

Diameter Size Range	Tolerance
2.0 to 4.0 (50,8 to 101,6)	± 0.020 (+0,5)
4.0 to 8.0 (101,6 to 203,2)	± 0.030 (+0,8)
8.0 to 12.0 (203,2 to 304,8)	± 0.046 (+1,2)
12.0 to 18.0 (304,8 to 457,2)	± 0.062 (+1,6)

FIGURE 2. CUT-TO-LENGTH

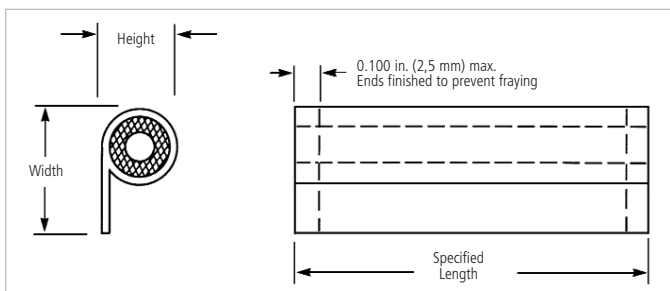

TOLERANCE ON LENGTH

Cut-to-Length Size Range	Tolerance
1.0 to 4.0 (25,4 to 101,6)	± 0.060 (+1,5)
4.0 to 8.0 (101,6 to 203,2)	± 0.060 (+1,5)
8.0 to 12.0 (203,2 to 304,8)	± 0.093 (+2,4)
12.0 to 18.0 (304,8 to 457,2)	± 0.125 (+3,2)
18.0 to 24.0 (457,2 to 609,6)	± 0.250 (+6,4)
24.0 to 30.0 (609,6 to 762,0)	+ 0.500/- 0.250 (+12,7/-6,4)
30.0 to 60.0 (762,0 to 1524,0)	+ 1.00/- 0.250 (+25,4/-6,4)
over 60.0 (1524,0)	+ 2.00/- 0.250 (+50,8/-6,4)





For applications requiring a resilient grounding medium with vibration dampening capabilities, Laird Technologies now manufactures a knitted wire washer. Designed for use in compression or rotary applications, these washers can be made in a variety of sizes and shapes.

The interlocking loop structure of the fine wire mesh in the compressed washer shape acts as a spring. The force of that spring is controlled by varying the washer material density.

The fine wire alloy materials can be varied to meet the demands of the most hostile environment—e.g., salt fog, harsh chemicals, extremes of heat or cold.

- Effective grounding combined with vibration dampening, for applications such as PC board mounting
- Spring action, provided by the wire knit mesh's interlocking loop structure. We will vary the material density to provide the spring force you specify.
- Wide choice of materials. Choose from the metal or alloy that best suits your needs: beryllium copper, Monel®, aluminum, tin plated steel or stainless steel.
- Other alloys available upon request.

Applications

ElectroGround™ washers can be used in compression or rotary applications. See Figures 1 through 4 below.



▲ Three variables—size, density, and the metal or alloy of the mesh—can be controlled to give you the optimum configuration of properties.

FIGURE 1.
WITH WASHER AND JAM NUT

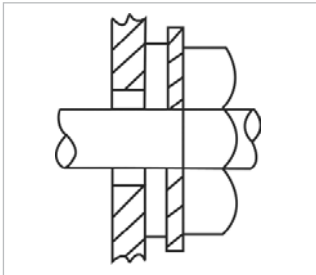

FIGURE 2.
WITH SHAFT SHOULDER

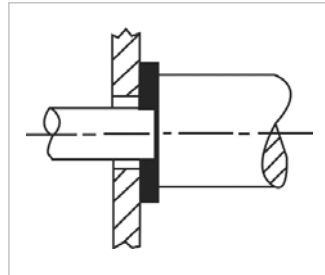

FIGURE 3.
WITH POSITIVE STOP CUP WASHER

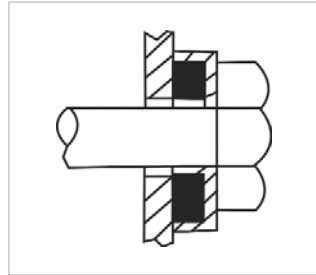
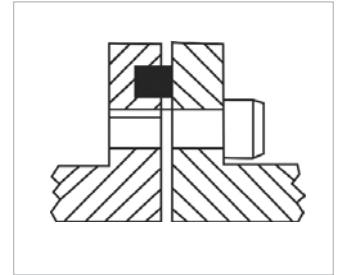

FIGURE 4.
MOUNTED IN FLANGE GROOVE



www.atd-elektronik.cz
www.atd-shop.com



FIGURE 5. ELECTROGROUND WASHER DIMENSIONS

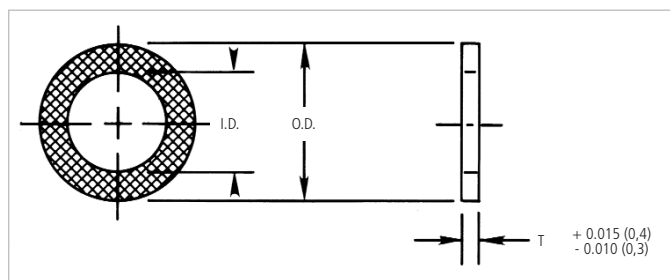

ELECTROGROUND WASHER SIZES, MATERIALS AND TOLERANCES

TABLE 1. DIMENSIONS

Laird Technologies Part No.	O.D.	I.D.	Free Height Maximum "T"
8904-0178-XX	0.200 (5,1)	0.125 (3,2)	0.032 (0,8)
8905-0178-XX	0.200 (5,1)	0.125 (3,2)	0.062 (1,6)
8906-0178-XX	0.200 (5,1)	0.125 (3,2)	0.093 (2,4)
8907-0178-XX	0.200 (5,1)	0.125 (3,2)	0.125 (3,2)
8908-0178-XX	0.200 (5,1)	0.125 (3,2)	0.156 (4,0)
8909-0178-XX	0.200 (5,1)	0.125 (3,2)	0.187 (4,7)
8910-0178-XX	0.200 (5,1)	0.125 (3,2)	0.250 (6,4)
8904-0107-XX	0.223 (5,7)	0.052 (1,3)	0.032 (0,8)
8902-0107-XX	0.223 (5,7)	0.052 (1,3)	0.062 (1,6)
8905-0107-XX	0.223 (5,7)	0.052 (1,3)	0.093 (2,4)
8901-0107-XX	0.223 (5,7)	0.052 (1,3)	0.125 (3,2)
8906-0107-XX	0.223 (5,7)	0.052 (1,3)	0.156 (4,0)
8907-0107-XX	0.223 (5,7)	0.052 (1,3)	0.187 (4,7)
8908-0107-XX	0.223 (5,7)	0.052 (1,3)	0.250 (6,4)
8902-0109-XX	0.225 (5,7)	0.120 (3,0)	0.032 (0,8)
8904-0109-XX	0.225 (5,7)	0.120 (3,0)	0.062 (1,6)
8905-0109-XX	0.225 (5,7)	0.120 (3,0)	0.093 (2,4)
8906-0109-XX	0.225 (5,7)	0.120 (3,0)	0.125 (3,2)
8907-0109-XX	0.225 (5,7)	0.120 (3,0)	0.156 (4,0)
8903-0109-XX	0.225 (5,7)	0.120 (3,0)	0.187 (4,7)
8908-0109-XX	0.225 (5,7)	0.120 (3,0)	0.250 (6,4)
8902-0118-XX	0.255 (6,5)	0.150 (3,8)	0.032 (0,8)
8906-0118-XX	0.255 (6,5)	0.150 (3,8)	0.062 (1,6)
8907-0118-XX	0.255 (6,5)	0.150 (3,8)	0.093 (2,4)
8904-0118-XX	0.255 (6,5)	0.150 (3,8)	0.125 (3,2)
8908-0118-XX	0.255 (6,5)	0.150 (3,8)	0.156 (4,0)
8901-0118-XX	0.255 (6,5)	0.150 (3,8)	0.187 (4,7)
8909-0118-XX	0.255 (6,5)	0.150 (3,8)	0.250 (6,4)
8902-0116-XX	0.375 (9,5)	0.240 (6,1)	0.032 (0,8)
8903-0116-XX	0.375 (9,5)	0.240 (6,1)	0.062 (1,6)

TABLE 1. DIMENSIONS (CONTINUED)

Laird Technologies Part No.	O.D.	I.D.	Free Height Maximum "T"
8901-0116-XX	0.375 (9,5)	0.240 (6,1)	0.093 (2,4)
8904-0116-XX	0.375 (9,5)	0.240 (6,1)	0.125 (3,2)
8905-0116-XX	0.375 (9,5)	0.240 (6,1)	0.156 (4,0)
8906-0116-XX	0.375 (9,5)	0.240 (6,1)	0.187 (4,7)
8907-0116-XX	0.375 (9,5)	0.240 (6,1)	0.250 (6,4)
8901-0117-XX	0.375 (9,5)	0.187 (4,8)	0.032 (0,8)
8905-0117-XX	0.375 (9,5)	0.187 (4,8)	0.062 (1,6)
8903-0117-XX	0.375 (9,5)	0.187 (4,8)	0.093 (2,4)
8902-0117-XX	0.375 (9,5)	0.187 (4,8)	0.125 (3,2)
8911-0117-XX	0.375 (9,5)	0.187 (4,8)	0.156 (4,0)
8912-0117-XX	0.375 (9,5)	0.187 (4,8)	0.187 (4,7)
8904-0117-XX	0.375 (9,5)	0.187 (4,8)	0.250 (6,4)
8909-0102-XX	0.459 (11,7)	0.335 (8,5)	0.032 (0,8)
8901-0102-XX	0.459 (11,7)	0.335 (8,5)	0.062 (1,6)
8910-0102-XX	0.459 (11,7)	0.335 (8,5)	0.093 (2,4)
8902-0102-XX	0.459 (11,7)	0.335 (8,5)	0.125 (3,3)
8911-0102-XX	0.459 (11,7)	0.335 (8,5)	0.156 (4,0)
8912-0102-XX	0.459 (11,7)	0.335 (8,5)	0.187 (4,7)
8905-0102-XX	0.459 (11,7)	0.335 (8,5)	0.250 (6,4)
8902-0110-XX	0.500 (12,7)	0.172 (4,4)	0.032 (0,8)
8903-0110-XX	0.500 (12,7)	0.172 (4,4)	0.062 (1,6)
8904-0110-XX	0.500 (12,7)	0.172 (4,4)	0.093 (2,4)
8901-0110-XX	0.500 (12,7)	0.172 (4,4)	0.125 (3,2)
8905-0110-XX	0.500 (12,7)	0.172 (4,4)	0.156 (4,0)
8906-0110-XX	0.500 (12,7)	0.172 (4,4)	0.187 (4,7)
8907-0110-XX	0.500 (12,7)	0.172 (4,4)	0.250 (6,4)
8907-0101-XX	0.500 (12,7)	0.212 (5,4)	0.032 (0,8)
8904-0101-XX	0.500 (12,7)	0.212 (5,4)	0.062 (1,6)
8901-0101-XX	0.500 (12,7)	0.212 (5,4)	0.093 (2,4)
8906-0101-XX	0.500 (12,7)	0.212 (5,4)	0.125 (3,2)
8908-0101-XX	0.500 (12,7)	0.212 (5,4)	0.156 (4,0)
8909-0101-XX	0.500 (12,7)	0.212 (5,4)	0.187 (4,7)
8902-0101-XX	0.500 (12,7)	0.212 (5,4)	0.250 (6,4)
8908-0122-XX	0.500 (12,7)	0.240 (6,1)	0.032 (0,8)
8909-0122-XX	0.500 (12,7)	0.240 (6,1)	0.062 (1,6)
8910-0122-XX	0.500 (12,7)	0.240 (6,1)	0.093 (2,4)
8903-0122-XX	0.500 (12,7)	0.240 (6,1)	0.125 (3,2)
8911-0122-XX	0.500 (12,7)	0.240 (6,1)	0.156 (4,0)
8912-0122-XX	0.500 (12,7)	0.240 (6,1)	0.187 (4,7)
8902-0122-XX	0.500 (12,7)	0.240 (6,1)	0.250 (6,4)
8904-0105-XX	0.500 (12,7)	0.312 (7,9)	0.032 (0,8)
8918-0105-XX	0.500 (12,7)	0.312 (7,9)	0.062 (1,6)
8919-0105-XX	0.500 (12,7)	0.312 (7,9)	0.093 (2,4)
8909-0105-XX	0.500 (12,7)	0.312 (7,9)	0.125 (3,2)
8903-0105-XX	0.500 (12,7)	0.312 (7,9)	0.156 (4,0)
8920-0105-XX	0.500 (12,7)	0.312 (7,9)	0.187 (4,7)
8910-0105-XX	0.500 (12,7)	0.312 (7,9)	0.250 (6,4)
8902-0108-XX	0.500 (12,7)	0.375 (9,5)	0.032 (0,8)
8907-0108-XX	0.500 (12,7)	0.375 (9,5)	0.062 (1,6)
8908-0108-XX	0.500 (12,7)	0.375 (9,5)	0.093 (2,4)
8909-0108-XX	0.500 (12,7)	0.375 (9,5)	0.125 (3,2)
8910-0108-XX	0.500 (12,7)	0.375 (9,5)	0.156 (4,0)
8906-0108-XX	0.500 (12,7)	0.375 (9,5)	0.187 (4,7)
8911-0108-XX	0.500 (12,7)	0.375 (9,5)	0.250 (6,4)

All dimensions shown are in inches (millimeters) unless otherwise specified.



www.atd-elektronik.cz
www.atd-shop.com



TABLE 1. DIMENSIONS (continued)

Laird Technologies Part No.	O.D.	I.D.	Free Height Maximum "T"
8908-0125-XX	0.525 (13,3)	0.355 (9,0)	0.032 (0,8)
8909-0125-XX	0.525 (13,3)	0.355 (9,0)	0.062 (1,6)
8904-0125-XX	0.525 (13,3)	0.355 (9,0)	0.093 (2,4)
8910-0125-XX	0.525 (13,3)	0.355 (9,0)	0.125 (3,2)
8911-0125-XX	0.525 (13,3)	0.355 (9,0)	0.156 (4,0)
8912-0125-XX	0.525 (13,3)	0.355 (9,0)	0.187 (4,8)
8903-0125-XX	0.525 (13,3)	0.355 (9,0)	0.250 (6,4)
8902-0129-XX	0.625 (15,9)	0.250 (6,4)	0.032 (0,8)
8903-0129-XX	0.625 (15,9)	0.250 (6,4)	0.062 (1,6)
8904-0129-XX	0.625 (15,9)	0.250 (6,4)	0.093 (2,4)
8905-0129-XX	0.625 (15,9)	0.250 (6,4)	0.125 (3,2)
8906-0129-XX	0.625 (15,9)	0.250 (6,4)	0.156 (4,0)
8907-0129-XX	0.625 (15,9)	0.250 (6,4)	0.187 (4,7)
8908-0129-XX	0.625 (15,9)	0.250 (6,4)	0.250 (6,4)
8911-0130-XX	0.625 (15,9)	0.370 (9,4)	0.032 (0,8)
8914-0130-XX	0.625 (15,9)	0.370 (9,4)	0.062 (1,6)
8913-0130-XX	0.625 (15,9)	0.370 (9,4)	0.093 (2,4)
8915-0130-XX	0.625 (15,9)	0.370 (9,4)	0.125 (3,2)
8901-0130-XX	0.625 (15,9)	0.370 (9,4)	0.156 (4,0)
8917-0130-XX	0.625 (15,9)	0.370 (9,4)	0.187 (4,7)
8904-0130-XX	0.625 (15,9)	0.370 (9,4)	0.250 (6,4)
8903-0180-XX	0.625 (15,9)	0.460 (11,7)	0.032 (0,8)
8904-0180-XX	0.625 (15,9)	0.460 (11,7)	0.062 (1,6)
8905-0180-XX	0.625 (15,9)	0.460 (11,7)	0.093 (2,4)
8906-0180-XX	0.625 (15,9)	0.460 (11,7)	0.125 (3,2)
8907-0180-XX	0.625 (15,9)	0.460 (11,7)	0.156 (4,0)
8901-0180-XX	0.625 (15,9)	0.460 (11,7)	0.187 (4,7)
8908-0180-XX	0.625 (15,9)	0.460 (11,7)	0.250 (6,4)
8903-0135-XX	0.625 (15,9)	0.490 (12,4)	0.032 (0,8)
8918-0135-XX	0.625 (15,9)	0.490 (12,4)	0.062 (1,6)
8919-0135-XX	0.625 (15,9)	0.490 (12,4)	0.093 (2,4)
8911-0135-XX	0.625 (15,9)	0.490 (12,4)	0.125 (3,2)
8916-0135-XX	0.625 (15,9)	0.490 (12,4)	0.156 (4,0)
8902-0135-XX	0.625 (15,9)	0.490 (12,4)	0.187 (4,7)
8906-0135-XX	0.625 (15,9)	0.490 (12,4)	0.250 (6,4)
8902-0137-XX	0.689 (17,5)	0.374 (9,5)	0.032 (0,8)
8903-0137-XX	0.689 (17,5)	0.374 (9,5)	0.062 (1,6)
8904-0137-XX	0.689 (17,5)	0.374 (9,5)	0.093 (2,4)
8905-0137-XX	0.689 (17,5)	0.374 (9,5)	0.125 (3,2)
8901-0137-XX	0.689 (17,5)	0.374 (9,5)	0.156 (4,0)
8906-0137-XX	0.689 (17,5)	0.374 (9,5)	0.187 (4,7)
8907-0137-XX	0.689 (17,5)	0.374 (9,5)	0.250 (6,4)
8903-0177-XX	0.750 (19,1)	0.187 (4,7)	0.032 (0,8)
8901-0177-XX	0.750 (19,1)	0.187 (4,7)	0.062 (1,6)
8904-0177-XX	0.750 (19,1)	0.187 (4,7)	0.093 (2,4)
8905-0177-XX	0.750 (19,1)	0.187 (4,7)	0.125 (3,2)
8906-0177-XX	0.750 (19,1)	0.187 (4,7)	0.156 (4,0)
8907-0177-XX	0.750 (19,1)	0.187 (4,7)	0.187 (4,7)
8908-0177-XX	0.750 (19,1)	0.187 (4,7)	0.250 (6,4)
8910-0140-XX	0.750 (19,1)	0.490 (12,4)	0.032 (0,8)
8907-0140-XX	0.750 (19,1)	0.490 (12,4)	0.062 (1,6)
8911-0140-XX	0.750 (19,1)	0.490 (12,4)	0.093 (2,4)
8912-0140-XX	0.750 (19,1)	0.490 (12,4)	0.125 (3,2)
8913-0140-XX	0.750 (19,1)	0.490 (12,4)	0.156 (4,0)
8901-0140-XX	0.750 (19,1)	0.490 (12,4)	0.187 (4,7)
8902-0140-XX	0.750 (19,1)	0.490 (12,4)	0.250 (6,4)

TABLE 1. DIMENSIONS (continued)

Laird Technologies Part No.	O.D.	I.D.	Free Height Maximum "T"
8903-0145-XX	0.800 (20,3)	0.650 (16,5)	0.032 (0,8)
8909-0145-XX	0.800 (20,3)	0.650 (16,5)	0.062 (1,6)
8911-0145-XX	0.800 (20,3)	0.650 (16,5)	0.093 (2,4)
8906-0145-XX	0.800 (20,3)	0.650 (16,5)	0.125 (3,2)
8911-0145-XX	0.800 (20,3)	0.650 (16,5)	0.156 (4,0)
8912-0145-XX	0.800 (20,3)	0.650 (16,5)	0.187 (4,7)
8904-0145-XX	0.800 (20,3)	0.650 (16,5)	0.250 (6,4)
8912-0150-XX	1.000 (25,4)	0.750 (19,1)	0.032 (0,8)
8913-0150-XX	1.000 (25,4)	0.750 (19,1)	0.062 (1,6)
8914-0150-XX	1.000 (25,4)	0.750 (19,1)	0.093 (2,4)
8915-0150-XX	1.000 (25,4)	0.750 (19,1)	0.125 (3,2)
8916-0150-XX	1.000 (25,4)	0.750 (19,1)	0.156 (4,0)
8903-0150-XX	1.000 (25,4)	0.750 (19,1)	0.187 (4,7)
8902-0150-XX	1.000 (25,4)	0.750 (19,1)	0.250 (6,4)
8904-0157-XX	1.140 (29,0)	0.826 (21,0)	0.032 (0,8)
8903-0157-XX	1.140 (29,0)	0.826 (21,0)	0.062 (1,6)
8905-0157-XX	1.140 (29,0)	0.826 (21,0)	0.093 (2,4)
8906-0157-XX	1.140 (29,0)	0.826 (21,0)	0.125 (3,2)
8907-0157-XX	1.140 (29,0)	0.826 (21,0)	0.156 (4,0)
8908-0157-XX	1.140 (29,0)	0.826 (21,0)	0.187 (4,7)
8909-0157-XX	1.140 (29,0)	0.826 (21,0)	0.250 (6,4)
8902-0156-XX	1.250 (31,8)	1.000 (25,4)	0.032 (0,8)
8903-0156-XX	1.250 (31,8)	1.000 (25,4)	0.062 (1,6)
8904-0156-XX	1.250 (31,8)	1.000 (25,4)	0.093 (2,4)
8905-0156-XX	1.250 (31,8)	1.000 (25,4)	0.125 (3,2)
8906-0156-XX	1.250 (31,8)	1.000 (25,4)	0.156 (4,0)
8907-0156-XX	1.250 (31,8)	1.000 (25,4)	0.187 (4,7)
8901-0156-XX	1.250 (31,8)	1.000 (25,4)	0.250 (6,4)
8902-0171-XX	1.254 (31,9)	1.114 (28,3)	0.032 (0,8)
8903-0171-XX	1.254 (31,9)	1.114 (28,3)	0.062 (1,6)
8904-0171-XX	1.254 (31,9)	1.114 (28,3)	0.093 (2,4)
8905-0171-XX	1.254 (31,9)	1.114 (28,3)	0.125 (3,2)
8906-0171-XX	1.254 (31,9)	1.114 (28,3)	0.156 (4,0)
8907-0171-XX	1.254 (31,9)	1.114 (28,3)	0.187 (4,7)
8908-0171-XX	1.254 (31,9)	1.114 (28,3)	0.250 (6,4)
8905-0168-XX	1.375 (34,9)	0.875 (22,2)	0.032 (0,8)
8906-0168-XX	1.375 (34,9)	0.875 (22,2)	0.062 (1,6)
8907-0168-XX	1.375 (34,9)	0.875 (22,2)	0.093 (2,4)
8904-0168-XX	1.375 (34,9)	0.875 (22,2)	0.125 (3,2)
8908-0168-XX	1.375 (34,9)	0.875 (22,2)	0.156 (4,0)
8901-0168-XX	1.375 (34,9)	0.875 (22,2)	0.187 (4,7)
8909-0168-XX	1.375 (34,9)	0.875 (22,2)	0.250 (6,4)
8906-0170-XX	1.375 (34,9)	1.125 (28,6)	0.032 (0,8)
8907-0170-XX	1.375 (34,9)	1.125 (28,6)	0.062 (1,6)
8908-0170-XX	1.375 (34,9)	1.125 (28,6)	0.093 (2,4)
8901-0170-XX	1.375 (34,9)	1.125 (28,6)	0.125 (3,2)
8909-0170-XX	1.375 (34,9)	1.125 (28,6)	0.156 (4,0)
8904-0170-XX	1.375 (34,9)	1.125 (28,6)	0.187 (4,7)
8902-0170-XX	1.375 (34,9)	1.125 (28,6)	0.250 (6,4)
8906-0174-XX	1.540 (39,1)	1.340 (34,0)	0.032 (0,8)
8907-0174-XX	1.540 (39,1)	1.340 (34,0)	0.062 (1,6)
8908-0174-XX	1.540 (39,1)	1.340 (34,0)	0.093 (2,4)
8902-0174-XX	1.540 (39,1)	1.340 (34,0)	0.125 (3,2)
8909-0174-XX	1.540 (39,1)	1.340 (34,0)	0.156 (4,0)
8910-0174-XX	1.540 (39,1)	1.340 (34,0)	0.187 (4,7)
8905-0174-XX	1.540 (39,1)	1.340 (34,0)	0.250 (6,4)

All dimensions shown are in inches (millimeters) unless otherwise specified.



www.atd-elektronik.cz
www.atd-shop.com



TABLE 1. DIMENSIONS (continued)

Laird Technologies Part No.	O.D.	I.D.	Free Height Maximum "T"
8903-0175-XX	1.625 (41,3)	1.125 (28,6)	0.032 (0,8)
8904-0175-XX	1.625 (41,3)	1.125 (28,6)	0.062 (1,6)
8905-0175-XX	1.625 (41,3)	1.125 (28,6)	0.093 (2,4)
8906-0175-XX	1.625 (41,3)	1.125 (28,6)	0.125 (3,2)
8907-0175-XX	1.625 (41,3)	1.125 (28,6)	0.156 (4,0)
8918-0175-XX	1.625 (41,3)	1.125 (28,6)	0.187 (4,7)
8909-0175-XX	1.625 (41,3)	1.125 (28,6)	0.250 (6,4)
8902-0176-XX	1.884 (47,9)	1.760 (44,7)	0.032 (0,8)
8901-0176-XX	1.884 (47,9)	1.760 (44,7)	0.062 (1,6)
8903-0176-XX	1.884 (47,9)	1.760 (44,7)	0.093 (2,4)
8904-0176-XX	1.884 (47,9)	1.760 (44,7)	0.125 (3,2)
8905-0176-XX	1.884 (47,9)	1.760 (44,7)	0.156 (4,0)
8916-0176-XX	1.884 (47,9)	1.760 (44,7)	0.187 (4,7)
8907-0176-XX	1.884 (47,9)	1.760 (44,7)	0.250 (6,4)

TABLE 2. MATERIALS

Material Code	Type	Wire Specification
40	Beryllium Copper	25 Alloy QQC-530
42	Monel®	QQN-281 Class A
43	Aluminum	5056 Alloy
44	Tin Plated Steel	ASTM B520
46	Stainless Steel	304

Other alloys available upon request.

TABLE 3. TOLERANCES

T Sizes	O.D.	I.D.
0.030 (0,8) to 0.062 (1,6)	± 0.010 (±0,3)	± 0.010 (±0,3)
0.062 (1,6) to 1.0 (25,4)	± 0.015 (±0,4)	± 0.015 (±0,4)
1.0 (25,4) to 2.0 (50,8)	± 0.020 (±0,5)	± 0.020 (±0,5)

How to Specify

- From Table 1 on pages 25 to 27, determine the O.D., the I.D., and the thickness "T" of the ElectroGround washer that suits the specific application. Note: Please consult Laird Technologies sales department for sizes not shown in Table 1.
- From Table 2, insert material code in place of XX in base part number.
- For tolerances O.D. and I.D. refer to Table 3.

Example:

- Dimensions required: O.D. = 0.200 I.D. = 0.125, and Thickness = 0.032 (from Table 1).
- Base Part Number: 8904-0178-XX (from Table 1).
- Material required is Beryllium Copper Code 40 (from Table 2).
- Full part number is 8904-0178-40.

All dimensions shown are in inches (millimeters) unless otherwise specified.



www.atd-elektronik.cz
www.atd-shop.com



Laird Technologies ElectroMesh tape has a double layered strip of knitted wire mesh to provide effective EMI shielding and grounding for electrical and electronic cable assemblies.

It is particularly useful in applications where the need for EMI protection is determined after cable assembly is complete and standard braided cable jackets cannot be used. The flexible structure of the ElectroMesh Tape permits it to conform to irregular surfaces and contours during the wrapping process.

- Tin plating for excellent solderability
- Useful in both shielding and grounding applications for static discharge
- Tin plated copper clad steel wire provides greater strength and performance than other tape materials
- Knit loop structure provides uniform coverage without any wrinkles or creases
- Available in other alloys and wire dimensions
- Supplied in 50 ft. (15,2 m) rolls. (Note: When determining quantity needed, 50% overlap is recommended.)
- Mesh tape also available in Monel® (material code 42); BeCu (material code 40); Aluminum (material code 43); and Stainless Steel (material code 46)
- Other alloys available upon request

ElectroMesh tape is 0.020 (0,5) thick. It is available in tin plated copper clad steel ASTM-B-250, with a diameter of 0.005 (0,1) and with 10–12 openings per inch.



TABLE 1. ELECTROMESH TAPE PART NUMBERS

Laird Technologies Part No.	Width
8300-0025-44	0.250 ± 0.040 (6,4 ± 1,0)
8300-0038-44	0.380 ± 0.040 (9,7 ± 1,0)
8300-0050-44	0.500 ± 0.060 (12,7 ± 1,5)
8300-0075-44	0.750 ± 0.060 (19,1 ± 1,5)
8300-0100-44	1.000 ± 0.060 (25,4 ± 1,5)
8300-0150-44	1.500 ± 0.120 (38,1 ± 3,1)
8300-0175-44	1.750 ± 0.120 (44,5 ± 3,1)
8300-0225-44	2.250 ± 0.190 (57,2 ± 4,8)

All dimensions shown are in inches (millimeters) unless otherwise specified.





Laird Technologies UltraSoft® Knit EMI gasket material consists of a metalized nylon yarn knit over a flame retardant UL 94 HF-1 low density foam polyester core material. The close-knit stitch of the metalized nylon provides a highly effective EMI shield, as well as a smooth, soft surface that will not abrade plated plastic interfaces.

- UL 94 HF-1 approved core
- Excellent shielding effectiveness averaging 110 dB @ 10 KHz to 1 GHz
- Self-terminating ends
- 95% coverage of core material provides a smooth appearance and surface resistivity
- Low closure force of 8 lbs per foot (11.93 kg per meter) @ 30% deflection
- Available in silver plated nylon to meet your galvanic compatibility needs
- Other finishes available upon request

PRODUCT SPECIFICATIONS

Materials

- EMI Shield: Silver plated nylon (material code 62)
- Foam Core: Low density UL 94 HF-1 approved polyester
- Pressure Sensitive Adhesive: Acrylic

Performance Characteristics

- Surface Resistivity: Silver plate 0.051 ohm/square inch @ 20% deflection
- Compression Set: 10% @ 50% deflection
- Temperature Range: Intermittent: -40°F to 225°F (-40°C to 107°C)

How to Order

1. Determine the size from Table 1 on page 30.
2. All sizes are supplied in standard 7-foot lengths (2,1 m). Other lengths available upon request.
3. Custom gasket assemblies: All sizes are offered cut to a specific length, ready for installation as shown in Figure 2, or as a bonded assembly as shown in Figure 3. Submit dimensions and quantity requirements to our sales department for price and delivery.

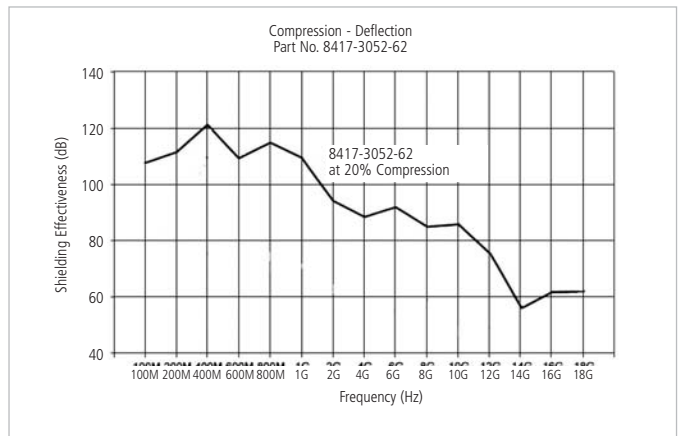
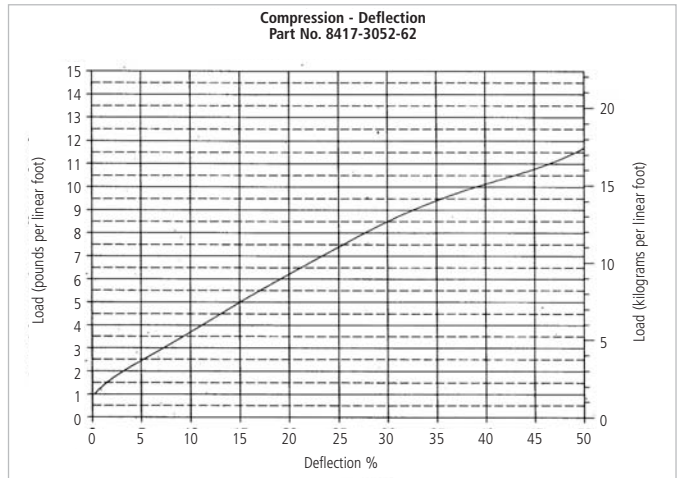

www.atd-elektronik.cz
www.atd-shop.com



FIGURE 1. ULTRASOFT KNIT RECTANGLE

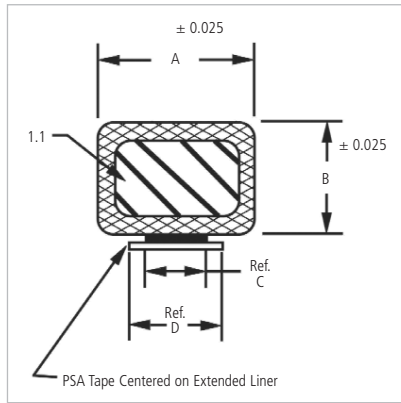

FIGURE 2. CUT-TO-LENGTH

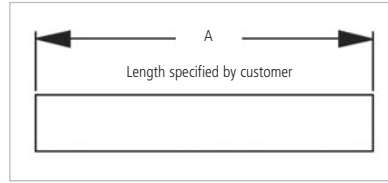

FIGURE 3. BONDED ASSEMBLY

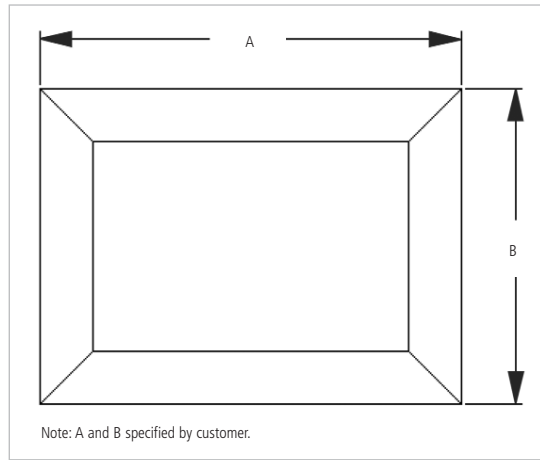

TABLE 1. ULTRASOFT KNIT GASKETS

Laird Technologies Part No.	A	B	C	D
8417-3073-62	0.125 (3,2)	0.050 (1,3)	0.075 (1,9)	0.261 (6,6)
8417-3063-62	0.125 (3,2)	0.060 (1,5)	0.075 (1,9)	0.261 (6,6)
8417-3050-62	0.125 (3,2)	0.125 (3,2)	0.075 (1,9)	0.261 (6,6)
8417-3064-62	0.150 (3,8)	0.150 (3,8)	0.075 (1,9)	0.261 (6,6)
8417-3072-62	0.187 (4,7)	0.125 (3,2)	0.093 (2,4)	0.279 (7,1)
8417-3051-62	0.187 (4,7)	0.187 (4,7)	0.093 (2,4)	0.279 (7,1)
8417-3060-62	0.250 (6,4)	0.080 (2,0)	0.110 (2,8)	0.296 (7,5)
8417-3052-62	0.250 (6,4)	0.125 (3,2)	0.110 (2,8)	0.296 (7,5)
8417-3078-62	0.250 (6,4)	0.202 (5,1)	0.110 (2,8)	0.296 (7,5)
8417-3053-62	0.250 (6,4)	0.250 (6,4)	0.125 (3,2)	0.311 (7,9)
8417-3065-62	0.276 (7,0)	0.150 (3,8)	0.110 (2,8)	0.296 (7,5)
8417-3059-62	0.313 (8,0)	0.313 (8,0)	0.150 (3,8)	0.336 (8,5)
8417-3054-62	0.375 (9,5)	0.125 (3,2)	0.150 (3,8)	0.336 (8,5)
8417-3055-62	0.375 (9,5)	0.187 (4,7)	0.150 (3,8)	0.336 (8,5)
8417-3062-62	0.375 (9,5)	0.250 (6,4)	0.150 (3,8)	0.336 (8,5)
8417-3068-62	0.375 (9,5)	0.375 (9,5)	0.150 (3,8)	0.336 (8,5)
8417-3056-62	0.500 (12,7)	0.125 (3,2)	0.200 (5,1)	0.386 (9,8)
8417-3057-62	0.500 (12,7)	0.250 (6,4)	0.200 (5,1)	0.386 (9,8)
8417-3067-62	0.500 (12,7)	0.500 (12,7)	0.200 (5,1)	0.386 (9,8)
8417-3066-62	0.827 (21,0)	0.150 (3,8)	0.400 (10,2)	0.586 (14,9)
8417-3058-62	1.000 (25,4)	1.000 (25,4)	0.400 (10,2)	0.586 (14,9)

All dimensions shown are in inches (millimeters) unless otherwise specified.



www.atd-elektronik.cz
www.atd-shop.com

GALVANIC CORROSION OF METALS

The galvanic series is a common means of ranking the relative activity of metallic couples. The galvanic series does not provide a measure of the corrosion current which will flow in a dissimilar metal couple, but it does indicate which couples are likely to incur significant corrosion damage. In galvanic couples consisting of two very incompatible metals, it is possible to reduce the corrosion rate through good design practice. In this situation, it is best to maximize the ratio of anode to cathode surface areas. For a particular current density, the corrosion rate on the more anodic metal will be lower the larger this ratio, because the corrosion reaction is spread over a larger surface area. In addition, if corrosion products build up on the cathode, they will build at a faster rate the smaller the surface area of the cathode relative to the anode. In this situation, the deposits could create a barrier that slows down corrosion.

The above technique is used in reverse to enhance the performance of electrical contacts. It is desirable that electrical contacts remain clean to provide a low resistance connection. When corrosion occurs, metal is removed from the more anodic metal. This process cleans the more anodic metal. By making the electrical contact out of one metal, and surrounding it by a larger surface area of a more cathodic metal, the contact will be cleaned by the corrosion reaction. The contact may corrode away eventually, but it will function more reliably during its shortened life.

The probability that two dissimilar metals will corrode when coupled together can be predicted from their difference in the electrochemical potentials. This information is tabulated in the Metals Galvanic Compatibility Chart on page 32. The common metals and their anodic index are listed along the left side of the chart. The metals are grouped in 0.05 volt increments, with some of the groups containing no common metals. Group Number One (left hand column) contains

the most cathodic metals and has an anodic index of zero. The anodic index increases as metals become more anodic. The arrow (on the far right hand side of the chart) points in the direction of increasingly anodic metals. On the right side of the chart, typical finishes available on metallic parts manufactured by Laird Technologies are listed along the top. The colored bars indicate the galvanic compatibility of these common finishes to the metals listed on the left. The color code is based on both the electrochemical differences between the metals and the finishes, and the corrosiveness of the environment. The chart shows that the force that drives the corrosion reactions is directly related to the electrochemical difference between any two metals. By reducing this difference, the corrosion rate is decreased.

Basic Corrosion Prevention

Whenever possible, avoid the use of dissimilar metals. The following five steps may be taken to prevent, or at least minimize corrosion potential in the event that it is necessary to use dissimilar metals in intimate contact with one another:

1. Limit contact between metals with widely different electrochemical potentials. The Metals Galvanic Compatibility Chart, on page 32, indicates which metal pairs have large differences in electrochemical potential.
2. Insert a third metal between the two dissimilar metals which reduces the potential difference of the galvanic couple. For example, nickel or tin plated copper are suitable for use with aluminum and silver combinations.
3. Design the flange interface so that the surface area of the anodic metal is significantly larger than the cathodic metal. The electromotive force (EMF) difference remains the same. However, the current density is decreased, so the corrosive attack on the cathodic metal is reduced.
4. Eliminate moisture, salts and other electrolytes from entering the joint interface by improved flange design or, if not possible, use an environmental seal outboard of the conductive element in a dual EMI shield/environmental seal.





METALS GALVANIC COMPATIBILITY CHART

GROUP NUMBER	Common Metal Surfaces METALLURGICAL CATEGORY	ANODIC INDEX, V
1	Gold; Au-Pt alloys; wrought platinum; graphite carbon	0.00
2		0.05
3	Rhodium plating	0.10
4	Silver; high-silver alloys	0.15
5		0.20
6		0.25
7	Nickel; nickel-copper alloys; titanium, titanium alloys; Monel®	0.30
8	Beryllium copper; low brasses or bronzes; silver solder; copper; Ni-Cr alloys; austenitic corrosion-resistant steels; most chrome-moly steels; specialty high-temp stainless steels	0.35
9	Commercial yellow brasses and bronzes	0.40
10	High brasses and bronzes; naval brass; Muntz metal	0.45
11	18% Cr type corrosion resistant steels; common 300 series stainless steels	0.50
12		0.55
13	Chromium or tin plating; 12% Cr type corrosion resistant steels; most 400 series stainless steels, i.e., 410 and some cast stainless steels	0.60
14	Terneplate; tin-lead solder	0.65
15	Lead; high-lead alloys	0.70
16	Wrought 2000 series aluminum alloys	0.75
17		0.80
18	Wrought gray or malleable iron; plain carbon and low-alloy steels; armco iron; cold-rolled steel	0.85
19	Wrought aluminum alloys except 2000 series cast Al-Si alloys; 6000 series aluminum	0.90
20	Cast aluminum alloys other than Al-Si; cadmium plating	0.95
21		1.00
22		1.05
23		1.10
24		1.15
25	Hot-dip galvanized or electrogalvanized steel	1.20
26	Wrought zinc; zinc die casting alloys	1.25
27		1.30
28		1.35
29		1.40
30		1.45
31		1.50
32		1.55
33		1.60
34		1.65
35		1.70
36	Wrought and cast magnesium alloys	1.75
37		1.80
38	Beryllium	1.85

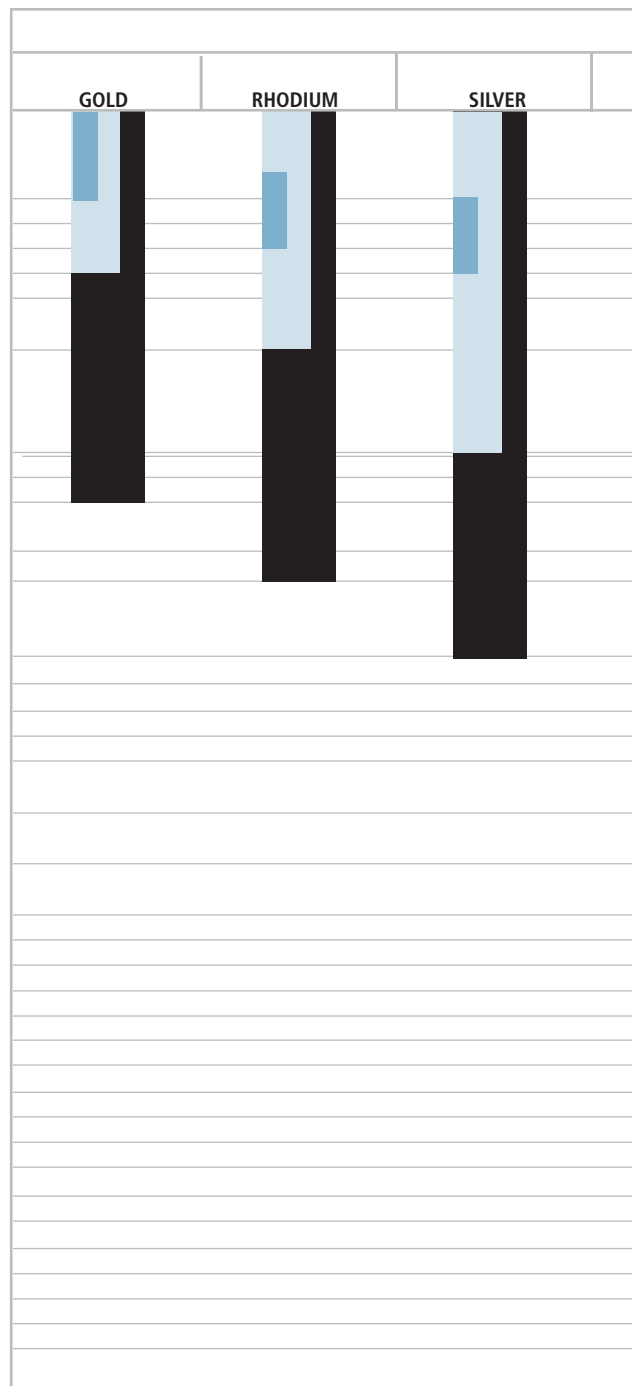

For harsh environments (presence of fair to good ionic conductors), all metals in contact with each other should be no more than one level of the chart apart to minimize corrosion. This is shown by the dark blue regions of the plating bar chart under specific platings. Outdoor applications, high humidity, and salt air fall into this category.

For normal environments (storage in warehouses or non-temperature/humidity-controlled environments, etc.), the difference between dissimilar metals should not exceed 0.25 volts (5 chart levels counting the origin). This is shown by the light blue regions of the chart under specific platings.



www.atd-elektronik.cz
www.atd-shop.com

METALS GALVANIC COMPATIBILITY CHART



COMPATIBLE SURFACE FINISHES FOR LAIRD TECHNOLOGIES PRODUCTS

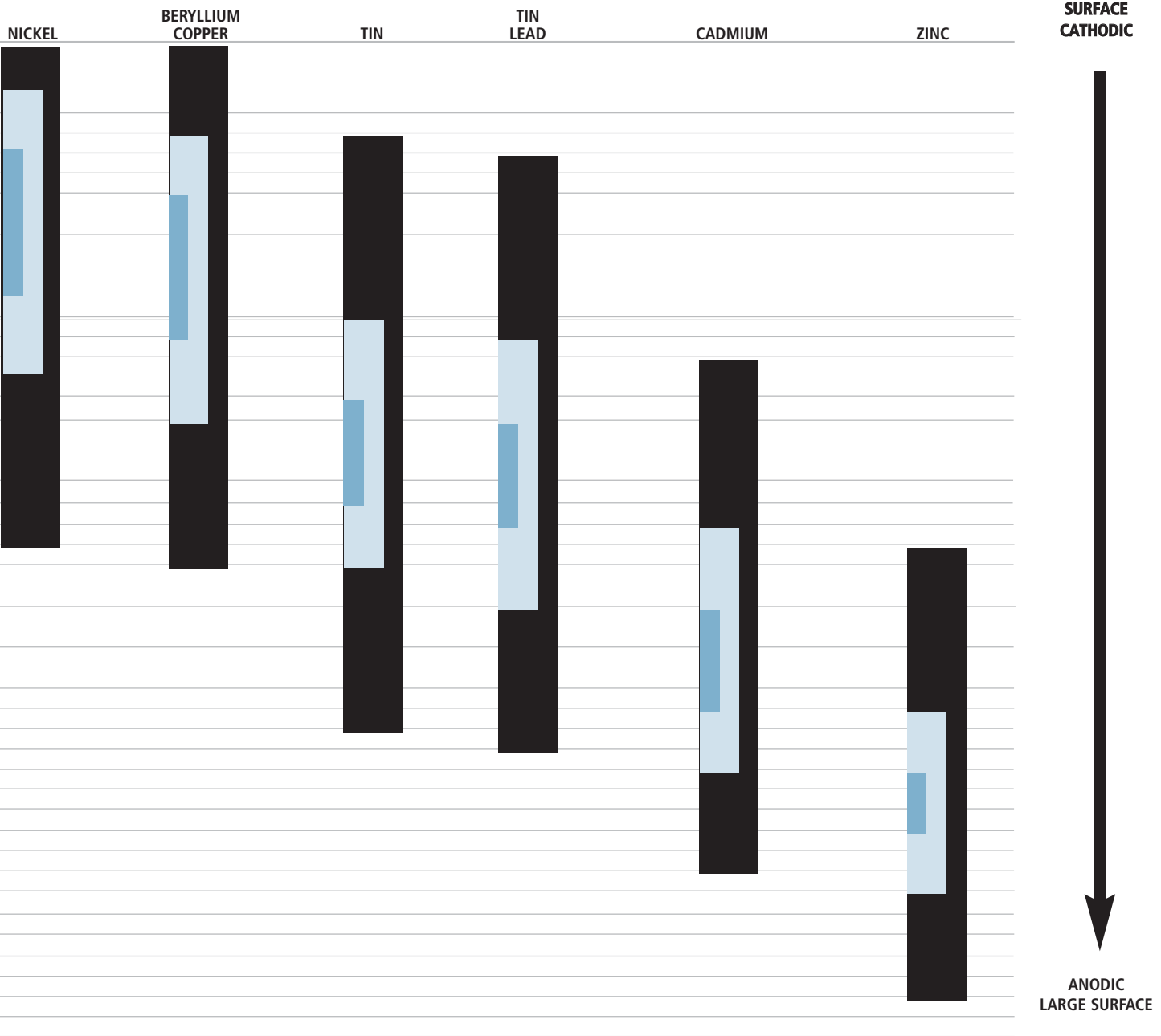

For office environments (temperature and humidity controlled), 0.5 volts can be tolerated (10 chart levels counting the origin). This is shown by the black regions under specific platings. Caution should be maintained when deciding that your application is temperature and humidity controlled. Many devices intended for use in office environments are stored in warehouses for extended periods of time before and in between use.

These are general guidelines which apply under most circumstances, but corrosion is a very complex subject whose details could not possibly fit in this space. If you are not sure which metals are compatible, please feel free to contact Laird Technologies and talk to our corrosion experts.



www.atd-elektronik.cz
www.atd-shop.com





NORTH AMERICA

USA toll-free telephone number
+1.800.843.4556

Delaware Water Gap, USA
Shielding Way
P.O. Box 650

Delaware Water Gap, PA 18327
Phone +1.570.424.8510
Fax +1.570.424.6213

Reynosa, Mexico
Industrial Center #5
Parque Industrial Reynosa
Calle Brecha E-99 NORTE
Lote 23, Reynosa
Tamaulipas 88780
Phone: +52-899-921-9000
Fax: +52-899-921-9038

St. Louis, USA
3481 Rider Trail South
St. Louis, MO 63045
Phone +1.314.344.9300
Fax +1.314.344.9333

San Jose, USA
2030 Fortune Drive
Suite 100
San Jose, CA 95131
Phone +1.408.544.9500
Fax +1.408.577.0691

San Marcos, USA
1825 Diamond Street
San Marcos, CA 92069
Phone +1.760.736.7007
Fax +1.760.736.7008

Schaumburg, USA
1751 Wilkening Court
Schaumburg, IL 60173
Phone +1.847.839.6000
Fax +1.847.519.9682

EUROPE

Germany
Äußere Oberaustraße 22
83026
Rosenheim, Germany
Phone +49.8031.24600
Fax +49.8031.246050

Czech Republic
Prumyslova 497
462 11 Liberec
Czech Republic
Phone +420.48.8575111
Fax +420.48.8575301

France
13-15 rue des Entrepreneurs
91560 Crosne, France
Phone +33.1.69497979
Fax +33.1.69497980

United Kingdom
Birches Industrial Estate
East Grinstead
West Sussex
RH19 1XH UK
Phone +44.1342.315044
Fax +44.1342.312969

ASIA

Taiwan
4F, No. 6
Hou-Sheng Road
Luchu, Taoyuan, Taiwan 338
Phone +886.33.129292
Fax +886.33.129090

Tokyo, Japan
Shin Yokohama Business Center
Building 7F
2-6, Shin Yokohama 3-chome,
Kohoku-ku
Yokohama-shi, Kanagawa
222-0033, Japan
Phone +81.45.4736808
Fax +81.45.4736162

Yokohama, Japan
2-12-8 Sachiura, Kanazawa-ku
Yokohama-shi, 236-0003, Japan
Phone +81.45.7851063
Fax +81.45.7851064

Kunshan, China
28 Huanghe South Road
Kunshan Economical & Technical
Development Zone
Kunshan City, China
Phone +86.512.5737-6767
Fax +86.512.5737-6766

Shanghai, China
Building 1, Number 58
Hua Ning Road, Lane 4018
Shanghai, P.R. China 201108
Phone +86.21.6442.8018
Fax +86.21.6489.6055

Shenzhen, China
No. 2 Building, 2nd Industry Park
Tangxiayong Songgang Town
Baoan District, Shenzhen City
Guangdong Province
China 518105
Phone +86.755.2714.1166
Fax +86.755.2714.1199

Suzhou, China
No. 228 Tongyuan Road
Suzhou Industry Park
Suzhou, P.R.China 215006
Phone +86.512.6252.6590
Fax +86.512.6252.7226

Tianjin, China
Building B, Fenghua
Industrial Park
66 on the Ninth Avenue, TEDA
Tianjin, P.R. China 300457
Phone +86.22.6629.8160
Fax +86.22.6629.8158

Singapore
750E Chai Chee Road
#03-07/08
Technopark@Chai Chee
Singapore 469005
Phone +65.624.38022
Fax +65.624.38021

Korea
A-4th Floor, Woorim
Lion's Valley
371-28, Gasan-Dong,
Gumcheon-Gu,
Seoul 153-786 Korea
Phone: +82.2.830.2095
Fax: +82.2.830.1945



www.atd-elektronik.cz
www.atd-shop.com

NOTICE: Although the information and recommendations set forth herein (hereinafter "information") are presented in good faith and believed to be correct as of the date hereof, Laird Technologies makes no representation or warranties as to the completeness or accuracy thereof. Information is supplied upon the condition that the persons receiving same will make their own determination as to its suitability for their purposes prior to use. In no event will Laird Technologies be responsible for damages of any nature whatsoever resulting from the use or reliance upon information or the product to which information refers. Nothing contained herein is to be construed as a recommendation to use any product, process, equipment or formulation in conflict with any patent, and Laird Technologies makes no representation or warranty, expressed or implied, that the use thereof will not infringe any patent. The data set forth in all tables, charts, graphs and figures herein are based on samples tested and are not guaranteed for all samples or applications. Such data are intended as guides and do not reflect product specifications for any particular product. NO REPRESENTATION OR WARRANTIES, EITHER EXPRESSED OR IMPLIED, OR MERCHANTABILITY, FITNESS FOR A PARTICULAR PURPOSE OR OF ANY OTHER NATURE ARE MADE HEREUNDER WITH RESPECT TO INFORMATION OR THE PRODUCT TO WHICH INFORMATION REFERS.