

SRW-25W Series



25W Ultra Wide Input Range Regulated Single output

Features

- Ultra Wide Input Range 16 -160, 72V Nominal
- 3000 VDC Isolation
- Efficiency up to 85%
- -40°C~ 100°C Operation Temperature Range
- Adjustable Output Voltage
- Remote On/Off Control (CTRL)
- Continuous Short Circuit Protection
- Over Load Protection
- Over Voltage Protection
- Over Temperature Protection
- Under voltage lock-out circuit
- EN 50155 approval for railway applications



The SRW series is a family of cost effective 25W single output DC-DC converters. These converters combine copper package in a 2.09"x1.09" case with high performance features such as continuous short circuit protection with automatic restart and tight line / load regulation. Devices are encapsulated using flame retardant resin. Ultra wide Input voltages from 16 to 160Vdc with output voltage of 5, 12, 15 and 24Vdc. High performance features include high efficiency operation up to 85% .

ALL SPECIFICATIONS ARE TYPICAL AT 25°C, NOMINAL INPUT AND FULL LOAD UNLESS OTHERWISE NOTED.

OUTPUT SPECIFICATIONS	
Output Voltage Accuracy	±1%, max.
Output Voltage Adjustability	±10%, max.
Maximum Output Current	See table
Line Regulation	±0.2%, max.
Load Regulation (0% to 100%)	±0.5%, max.
Ripple&Noise (1)	100mVp-p,max.
Over Voltage Protection (Zener diode clamp)	5V output 6.2V 12V output 15V 15V output 18V 24V output 30V
Over Current Protection	150% of FL, typ.
Short Circuit Protection	Indefinite(hiccup) (Automatic Recovery)
Stability(2)	±0.5%
Temperature Coefficient	±0.02%/°C
Capacitive Load (3)	See table
Transient Recovery Time (4)	500us, typ.
Transient Response Deviation (4)	±4%, max.
INPUT SPECIFICATIONS	
Input Voltage Range	See table
Under Voltage Lockout	Module ON / OFF 13.8Vdc / 12Vdc, typ.
Start up Time (Nominal Vin and constant resistive load)	60mS, typ.
Input Filter	Pi Type
Input Current (No-Load)	See table, max.
Input Current (Full-Load)	See table, typ.
Input Reflected Ripple Current (5)	20mA _{p-p} , typ.
Remote On/Off (CTRL) (6)	ON: 3.0 ... 12Vdc or open circuit OFF: 0 ... 1.2Vdc or Short circuit pin2 and pin 3 OFF idle current: 3 mA, typ.
ENVIRONMENTAL SPECIFICATIONS	
Operating Ambient Temperature	-40°C ~ +100°C(See Derating Curve) -40°C ~ +58°C(For 100% load)
Maximum Case Temperature	105°C
Thermal Impedance (Mounting at FR4 (5.9"x2.75 inch) PCB)	8°C/W, min.
Storage Temperature	-55°C ~ +125°C
Over Temperature Protection (Case)	115°C, typ.
Cooling(7)	Nature Convection
Thermal shock	IEC60068
Shock	EN61373
Vibration	EN61373

GENERAL SPECIFICATIONS	
Efficiency	See table, typ.
I/O Isolation Voltage (60sec)	
Input/Output	3000 Vdc , Basic Insulation
Case/Input & Output	1600Vdc
Isolation Resistance	1000 MΩ, min.
Isolation Capacitance	2000 pF, typ.
Switching frequency	250kHz, typ.
Humidity	95% rel H
Reliability Calculated MTBF (MIL-HDBK-217 F)	>230Khrs
Safety Standard :	IEC/EN 60950-1 IEC/EN 62368-1 EN50155
Safety Approvals :	IEC/EN 60950-1 IEC/EN 62368-1 EN50155

EMC SPECIFICATIONS			
Radiated Emissions	EN50121-3-2	40dBuV from 30-230MHZ 47dBuV from 230-1000MHZ	
Conducted Emissions(8)	EN50121-3-2	99dBuV from 0.15-0.5MHZ 93dBuV from 0.5-30MHZ	
ESD	EN50121-3-2	Air ± 8KV Contact ± 6KV	Perf. Criteria A
RS	EN50121-3-2	20V/m	Perf. Criteria A
EFT (9)	EN50121-3-2	2.0KV	Perf. Criteria A
Surge (9)	EN50121-3-2	2.0KV	Perf. Criteria A
CS	EN50121-3-2	10V	Perf. Criteria A
PFMF	EN61000-4-8	100A/m	Perf. Criteria A

PHYSICAL SPECIFICATIONS	
Case Material	Aluminum
Base Material	Non-conductive Black Plastic(UL94V-0 rated)
Pin Material	Φ1.0mm Brass Solder-coated
Potting Material	Epoxy (UL94V-0 rated)
Weight	48.0g
Dimensions	2.09"x1.09"x0.65"

ABSOLUTE SPECIFICATIONS (10)	
These are stress ratings. Exposure of devices to any of these conditions may adversely affect long-term reliability.	
Input Surge Voltage (100mS)	176 Vdc, max.
Soldering Temperature (1.5mm from case 10 sec. max.)	260°C, max.

SRW - 25W Regulated Single output

PART NUMBER STRUCTURE

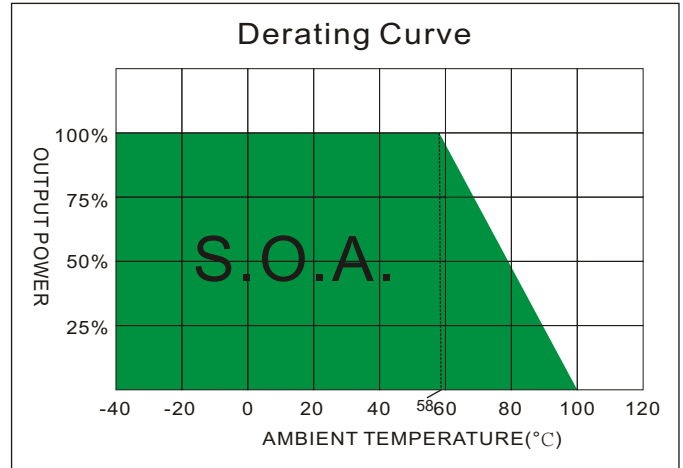
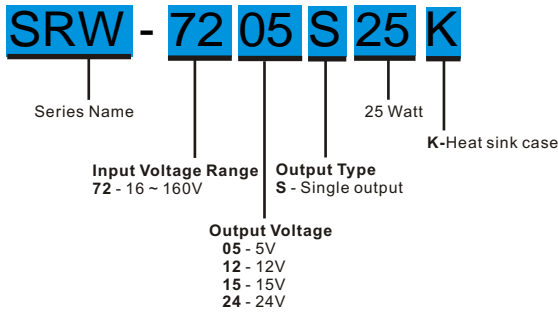

MODEL SELECTION GUIDE

MODEL NUMBER	INPUT	INPUT Current		OUTPUT	OUTPUT Current		EFFICIENCY @FL(%)	Capacitor Load(μF)
	Voltage Range (Vdc)	No-Load (mA)	Full Load (mA)	Voltage (Vdc)	Min. load (mA)	Full load (mA)		
SRW-7205S25K	16-160,72V Nominal	10	413.36	5	0	5000	84	6800
SRW-7212S25K	16-160,72V Nominal	10	412.70	12	0	2080	84	1000
SRW-7215S25K	16-160,72V Nominal	10	409.31	15	0	1670	85	820
SRW-7224S25K	16-160,72V Nominal	10	407.84	24	0	1040	85	470

NOTE

1. Measured with 20MHz bandwidth and 10.0uF ceramic capacitor.
2. After 20 minute warm up at full load.
3. Tested by minimal Vin and constant resistive load.
4. Tested by normal Vin and 25% load step change (75%-50%-25% of Io) at 0.1A/μs.
5. Measured Input reflected ripple current with a simulated source inductance of 22μH and two electrolytic source capacitors C1(8.2uF, 250V) and C2(10uF, 250V).
Requirement for the module,Which application refer to the Input Reflected Ripple Current Test Step & EMI Filter For EN55032.
6. The remote on/off control pin is referenced to -Vin(pin2).
7. "Nature Convection" is usually about 30-65 LFM but is not equal to still air (0 LFM).
8. Input filter components are used to meet input conducted emission 79dBμV from 0.15-0.5MHZ and 73dBμV from 0.5-30MHZ.
Requirement for the module,Which application refer to the Input Reflected Ripple Current Test Step & EMI Filter For EN55032.
And output filter components are used to meet EN50121-3-2:2016 output conducted emission.
Requirement for the module,Which application refer to the EMI Filter For EN50121-3-2:2016.
9. An external filter capacitor is required if the module has to meet EFT and Surge in EN50121-3-2.
The filter capacitor SCHMID-M suggest:
SRW-72XXS25K : two electrolytic capacitors (Ruby-con BXF series, 100μF/250V) in parallel.
- 10.Exceeding the absolute ratings of the unit could cause damage.It is not allowed for continuous operating.

Single & Dual Series - TEST CONFIGURATIONS

Input Reflected Ripple Current Test Step & EMI Filter For EN55032

Input reflected ripple current is measured through a source inductor L_{in} (22uH) and two source electrolytic capacitor $C1$ (8.2uF, 250V) and $C2$ (10uF, 250V) at nominal input and full load.

And the components are also used to meet input conducted emission 79dB μ V from 0.15-0.5MHz and 73dB μ V from 0.5-30MHz.

These components should be mounted as close as possible to the module; and all leads should be minimized to decrease radiated noise.

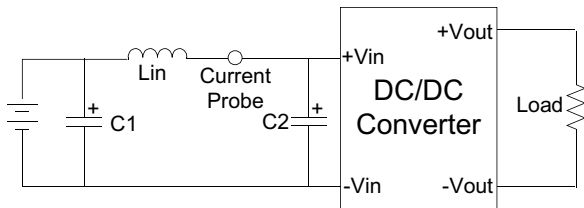

Output Ripple & Noise Measurement Test

Use a capacitor C_{out} (10uF) measurement. The Scope measurement bandwidth is 0-20MHz.

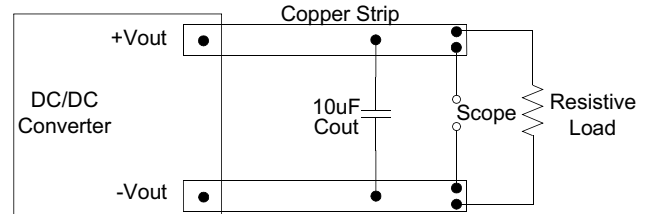

DESIGN & FEATURE CONFIGURATIONS

Output Ripple & Noise Reduction

To reduce ripple and noise, it is recommended to use a 1uF ceramic disk capacitor and a 10uF electrolytic capacitor at the output.

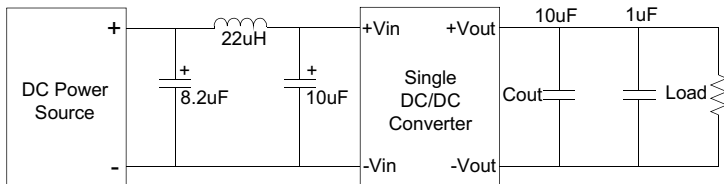

Over Current Protection

The module includes an internal over current protection circuit, which will endure current limiting for an unlimited duration during output over load condition. If the output current exceeds the OCP set point, the module will shut down automatically (hiccup).

The module will try to restart after shut down. If the over load condition still exists, the module will shut down again.

Over Voltage Protection

The module includes an internal output over voltage protection circuit, which monitors the voltage on the output terminals. If this voltage exceeds the over voltage set point, the module will activate the control loop of internal circuit to clamp the output voltage.

EMI Filter For EN50121-3-2:2016

Output filter components are used to meet EN50121-3-2:2016 output conducted emission.

These components should be mounted as close as possible to the module; and all leads should be minimized to decrease radiated noise.

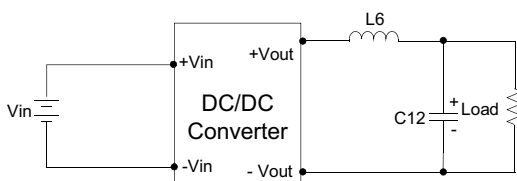

	L6	C12
SRW-72YS25K	4.7uH	22uF, 100V

CTRL Module ON / OFF

Positive logic turns on the module during high logic and off during low logic.

Ctrl module on/off can be controlled by an external switch between the ctrl terminal and -Vin terminal. The switch can be an open collector or open drain

For positive logic if the ctrl feature is not used, please leave the ctrl pin floating.

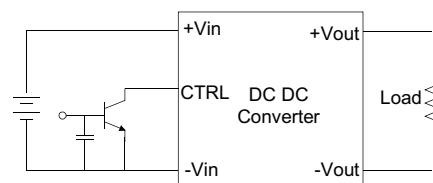

MECHANICAL SPECIFICATIONS

Heat sink case

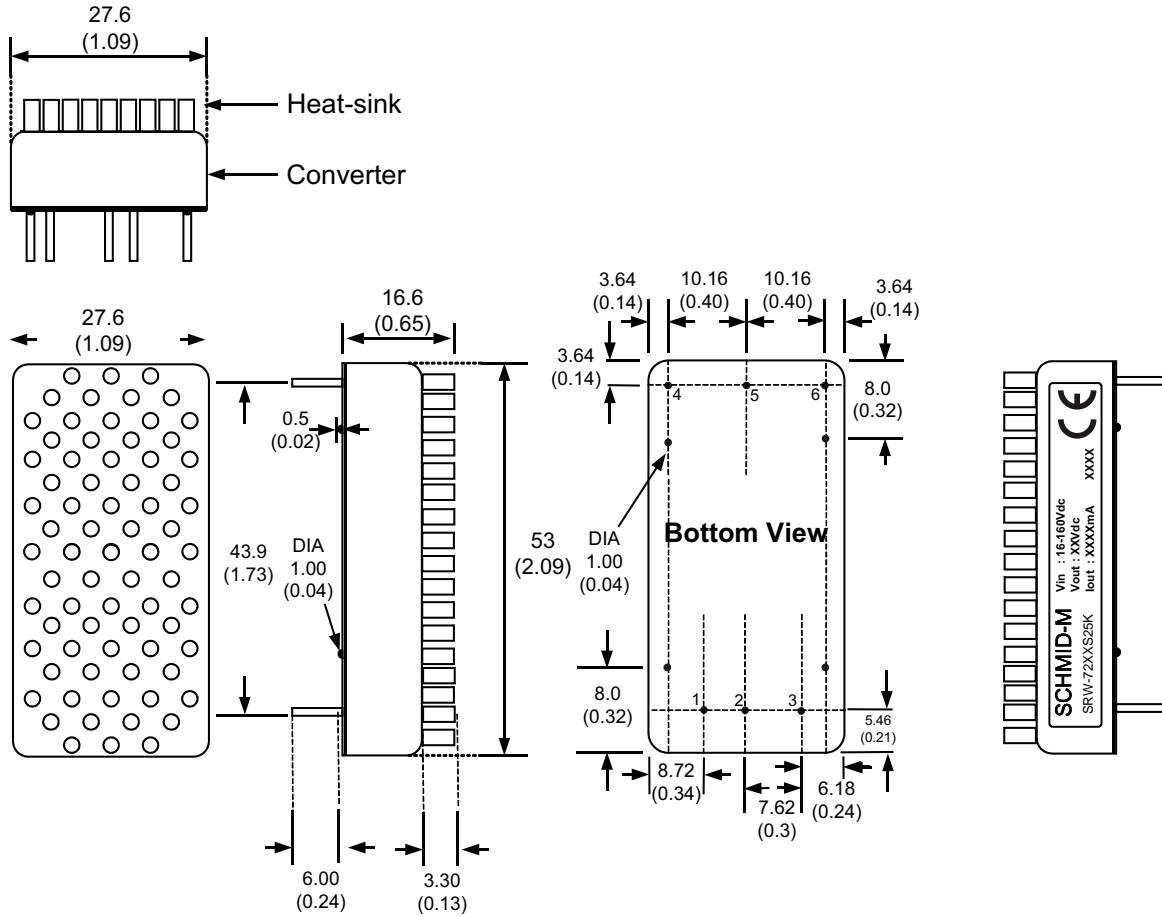

All dimensions are typical in millimeters (inches).

1. Pin diameter: 1.0 ± 0.05 (0.04 ± 0.002)
2. Pin pitch and length tolerance: ± 0.35 (± 0.014)
3. Case Tolerance: ± 0.5 (± 0.02)
4. Stand-off Tolerance: ± 0.1 (± 0.004)

PIN CONNECTIONS	
PIN NUMBER	SINGLE
1	+Vin
2	-Vin
3	CTRL
4	+Vout
5	-Vout
6	Trim

