

Products overview

50/60 Hz PCB Mount Transformers

EE 20-6.1-PE20 Series	0.35W	(page 3)
EE 20-10-PE20 Series	0.35W	
EI 30-5-PE3005 Series	0.6W	
EI 30-10.5-PE3010 Series	1W	
EI 30-12.5-PE3012 Series	1.5W	
EI 30-15.5-PE3015 Series	2W	
EI 30-18-PE3018 Series	2.3W	
EI 30-13.6-PE3818 Series	3.2W	
EI 42-14.8-PE4214 Series	5W	
EI 48-16.8-PE4816 Series	10W	
EI 54-18.8-PE5418 Series	16W	
EI 60-21-PE6021 Series	22W	
EI 66-23-PE6623 Series	30W	(page 4)
UI 21 Series	1W	(page 5)
30×5.5 – UI 3005 Series	3W	
30×5.5 – UI 3005 Series	4W	
30×10.5 – UI 3010 Series	6W	
30×16.5 – UI 3016 Series	10W	
39×10.2 – UI 3910 Series	14W	
39×13.5 – UI 3913 Series	18W	
39×17 – UI 3917 Series	24W	
39×21 – UI 3921 Series	30W	
48×17 – UI 4817 Series	40W	
48×26 – UI 4826 Series	60W	(page 6)

Power Ferrite Transformers

E16 - Single output flyback transformers	1-6W	(page 7)
E16 - 2 output flyback transformers	1-6W	
E16 - Single output transformers for tinyswitschs	1-9W	
E16 - 2 output flyback transformers	6-12W	
E16 - 3 output flyback transformers	6-12W	(page 8)
EL19 - 2 output flyback transformers	10-18W	
EL19 - 5 output flyback transformers	10-18W	
EF20 - 2 output flyback transformers	12-24W	
EF20 - 3 output flyback transformers	12-24W	
E25 - 3 or 1 output flyback transformers	15-30W	(page 9)
ERL28 - 4 output flyback transformers	30-60W	
ETD34 - 4 output flyback transformers	60-90W	
ETD39 - 4 output flyback transformers	70-140W	
ETD44-4 output flyback transformers	120-180W	(page 10)

SMT Line matching Transformers

SM-LP-5001 Series	10dBm	(page 11)
SM-LP-5002 Series	10dBm	

SMT Line matching Transformers

AT 16xx Series	Low profile (page 12)
AT Series	Low profile

Telecom Transformers

RM & POT Series	(page 13)
EFD & ER Series	
EP Series	
RM SMD Series	(page 14)

Switching Transformers

TEE, TEI Series	3-814 VA (page 15)
TER Series.....	3-850 VA
TETD Series.....	110-900 VA
TPQ Series	92-1045 VA (page 16)
TEFD Series.....	5-70 VA

Through-Hole current sensing Transformers

ACST 010-013 Series.....	PBT94V0 Case (page 17)
ACST 014-016 Series.....	PBT94V0 Case

High Frequency current sensing Transformers

ACST Series.....	(page 18)
------------------	-----------

RF Transformers

RF 5S, 5SL Series	1.5-1400MHz (page 19)
-------------------------	-----------------------

ADSL Central Office Post Splitter

ADSL-205, 213 Series	(page 20)
----------------------------	-----------

ADSL Transformers

ADSL 100 Series	(page 21)
-----------------------	-----------

SMD low profile switching Transformers

SPT Series	(page 22)
------------------	-----------

For more information, please, contact us:



Luženice 10
Domažlice
344 01

tel.: +420379723915
fax.: +420379725868
info@atd-elektronik.cz
www.atd-elektronik.cz



50/60HZ PCB MOUNT TRANSFORMERS – EI RANGE

0.6W EI 30-5-PE3005 SERIES

FEATURES:

- Vacuum filling
- Two compartments bobbins
- Self-extinguishing plastics UL 94 VO
- Degree of protection IP 00
- 40 grams weight

OPTIONS:

- Bulk packaging is standard
- Custom design available

COMMON APPLICATIONS:

- Medical equipments
- Industrial equipments
- Industrial controls
- Test equipment
- Industrial computers
- Avionics & telecom

ELECTRICAL CHARACTERISTICS

PRIMARY VOLTAGE: 230						PRIMARY VOLTAGE: 115					
Part Number	Secondary voltage V	Secondary Current m A	No-load voltage V	Ambient Temperature °C	Rating VA	Part Number	Secondary voltage V	Secondary Current m A	No-load voltage V	Ambient Temperature °C	Rating VA
PE300513	6	100	9.94	T70B	0.6	PE300525	6	100	9.94	T70B	0.6
PE300514	9	66	14.95	T70B	0.6	PE300526	9	66	14.95	T70B	0.6
PE300515	12	50	19.9	T70B	0.6	PE300527	12	50	19.9	T70B	0.6
PE300516	15	40	24.9	T70B	0.6	PE300528	15	40	24.9	T70B	0.6
PE300517	18	33	29.9	T70B	0.6	PE300529	18	33	29.9	T70B	0.6
PE300518	24	25	39.8	T70B	0.6	PE300530	24	25	39.8	T70B	0.6
PE300519	2 × 6	2 × 50	2 × 9.94	T70B	0.6	PE300531	2 × 6	2 × 50	2 × 9.94	T70B	0.6
PE300520	2 × 9	2 × 33	2 × 14.95	T70B	0.6	PE300532	2 × 9	2 × 33	2 × 14.95	T70B	0.6
PE300521	2 × 12	2 × 25	2 × 19.9	T70B	0.6	PE300533	2 × 12	2 × 25	2 × 19.9	T70B	0.6
PE300522*	2 × 15	2 × 20	2 × 24.9	T70B	0.6	PE300534	2 × 15	2 × 20	2 × 24.9	T70B	0.6
PE300523*	2 × 18	2 × 17	2 × 29.9	T70B	0.6	PE300535	2 × 18	2 × 17	2 × 29.9	T70B	0.6
PE300524*	2 × 24	2 × 12	2 × 39.8	T70B	0.6	PE300536	2 × 24	2 × 12	2 × 39.8	T70B	0.6

*Note: non safety transformer approved, conform to EN 61558-2-6 (isolating transformer).

TECHNICAL INFORMATION

- Resin class B CEI 85 (20000 h testing to CEI 126)
- Inherently short-circuits proof transformer
- UL approved primary versions: 24V, 48V, 240V (production on request)
- Insulation voltage 4 KV
- 100% tested production
- Certification : CCA procedure on request

1 Secondary winding

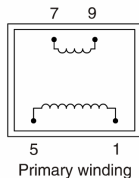

2 Secondary winding

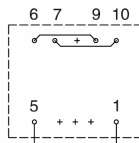
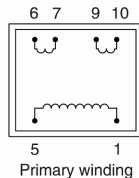

PHYSICAL CHARACTERISTICS

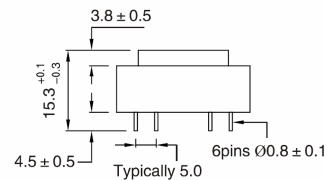
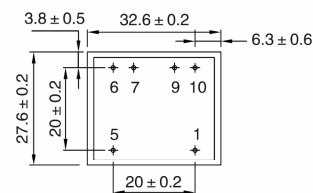

All dimensions in mm

Recommended Drill-hole Diameter for 1.3mm pins



50/60HZ PCB MOUNT TRANSFORMERS – EI RANGE

30W EI 66-23-PE6623 SERIES

FEATURES:

- Vacuum filling
- Two compartments bobbins
- Self-extinguishing plastics UL 94 VO
- Degree of protection IP 00
- 700 grams weight

OPTIONS:

- Bulk packaging is standard
- Custom design available

COMMON APPLICATIONS:

- Medical equipments
- Industrial equipments
- Industrial controls
- Test equipment
- Industrial computers
- Avionics & telecom

ELECTRICAL CHARACTERISTICS

PRIMARY VOLTAGE: 230						PRIMARY VOLTAGE: 115					
Part Number	Secondary voltage V	Secondary Current m A	No-load voltage V	Ambient Temperature °C	Rating VA	Part Number	Secondary voltage V	Secondary Current m A	No-load voltage V	Ambient Temperature °C	Rating VA
PE662373	6	5000	6.9	T50B	30	PE662385	6	5000	6.9	T50B	30
PE662374	9	333	10.3	T50B	30	PE662386	9	333	10.3	T50B	30
PE662375	12	2500	13.8	T50B	30	PE662387	12	2500	13.8	T50B	30
PE662376	15	2000	17.2	T50B	30	PE662388	15	2000	17.2	T50B	30
PE662377	18	1667	20.8	T50B	30	PE662389	18	1667	20.8	T50B	30
PE662378	24	1250	27.7	T50B	30	PE662390	24	1250	27.7	T50B	30
PE662379	2 x 6	2 x 2500	2 x 6.9	T50B	30	PE662391	2 x 6	2 x 2500	2 x 6.9	T50B	30
PE662380	2 x 9	2 x 1667	2 x 10.3	T50B	30	PE662392	2 x 9	2 x 1667	2 x 10.3	T50B	30
PE662381	2 x 12	2 x 1250	2 x 13.8	T50B	30	PE662393	2 x 12	2 x 1250	2 x 13.8	T50B	30
PE662382	2 x 15	2 x 1000	2 x 17.2	T50B	30	PE662394	2 x 15	2 x 1000	2 x 17.2	T50B	30
PE662383	2 x 18	2 x 833	2 x 20.8	T50B	30	PE662395	2 x 18	2 x 833	2 x 20.8	T50B	30
PE662384*	2 x 24	2 x 625	2 x 27.7	T50B	30	PE662396	2 x 24	2 x 625	2 x 27.7	T50B	30

* To be noted : 2 x 24 V non safety transformer approved, conform to EN 61558-2-6 (Isolating transformer).

TECHNICAL INFORMATION

- Resin class B CEI 85 (20 000 h testing to CEI 126)
- Fuse protection on primary side (see diagram) to be assumed by customer
- 30 V and 36 V models are VDE EN 61558-2-6 certified (production on request)
- Insulation voltage 4 KV
- 100% tested production
- Certification : CCA procedure on request

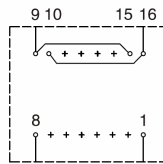
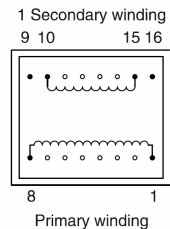
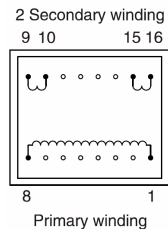

PHYSICAL CHARACTERISTICS

All dimensions in mm

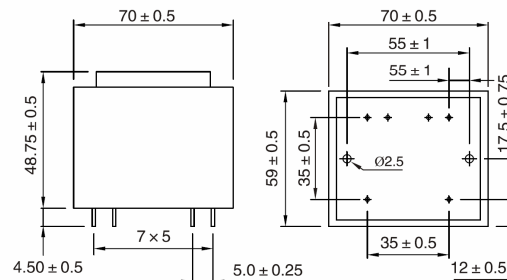

Recommended Drill-hole Diameter for 1.3mm pins
Recommended Drill-hole Diameter for Mountings=4mm

50/60HZ PCB MOUNT TRANSFORMERS – UI RANGE

1W UI 21 SERIES



FEATURES:

- 115V–230V supply voltage by serie/parallel connection
- Vacuum filling
- One compartment housing
- Degree of protection IP 00
- 50 grams weight

OPTIONS:

- Bulk packaging is standard
- Custom design available

COMMON APPLICATIONS:

- Medical equipments
- Industrial equipments
- Industrial controls
- Test equipment
- Industrial computers
- Avionics & telecom

ELECTRICAL CHARACTERISTICS

PRIMARY VOLTAGE: 230				
Part Number	Secondary voltage V	Secondary Current mA	No-load voltage V	Ambient Temperature °C
UI 2101	6	167	11.4	T70B
UI 2102	9	111	17	T70B
UI 2103	12	83	22.8	T70B
UI 2104	15	67	28.5	T70B
UI 2105	18	56	34.2	T70B
UI 2106	24	42	45.6	T70B

TECHNICAL INFORMATION

- Resin UL 94 VO
- Design protection against short-circuits
- Insulation voltage 4 KV
- 100% tested production

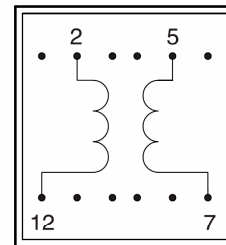

PHYSICAL CHARACTERISTICS

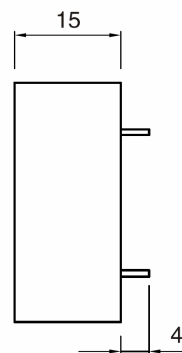
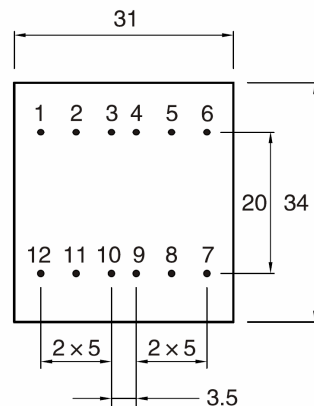

All dimensions in mm

50/60HZ PCB MOUNT TRANSFORMERS – UI RANGE

60W 48 × 26–UI 4826 SERIES

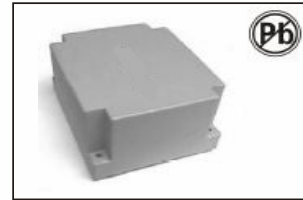

FEATURES:

- 115 V–230 V supply voltage by serie/parallel connection
- Vacuum filling
- Two compartments bobbins
- Degree of protection IP 00

OPTIONS:

- Bulk packaging is standard
- Custom design available

COMMON APPLICATIONS:

- Medical equipments
- Industrial equipments
- Industrial controls
- Test equipment
- Industrial computers
- Avionics & telecom

ELECTRICAL CHARACTERISTICS

PRIMARY VOLTAGE: 115~230				
Part Number	Secondary voltage V	Secondary Current m A	No-load voltage V	Ambient Temperature °C
UI 482673	2 × 6	2 × 5000	2 × 6.6	T50B
UI 482674	2 × 9	2 × 3333	2 × 9.9	T50B
UI 482675	2 × 12	2 × 2500	2 × 13.1	T50B
UI 482676	2 × 15	2 × 2000	2 × 16.4	T50B
UI 482677	2 × 18	2 × 1667	2 × 19.7	T50B
UI 482678	2 × 24	2 × 1250	2 × 26.3	T50B

PHYSICAL CHARACTERISTICS

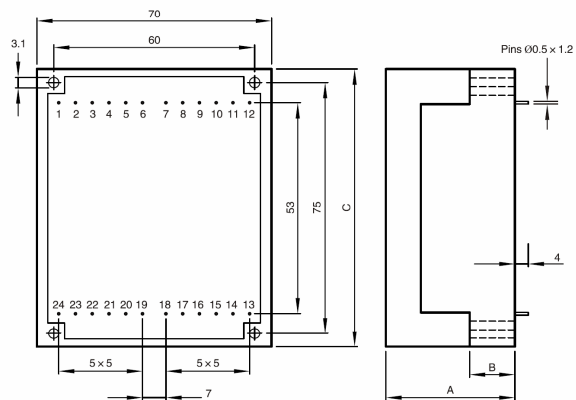

All dimensions in mm

TECHNICAL INFORMATION

- Resin class UL 94 VO
- Fuse protection in secondary winding (see diagram)
- 100% tested production
- Conform to EN 61558 Approval under process
- UL 506 approved

CIRCUIT	RATING	A	B	C	WEIGHT(g)
UI39 × 8	10VA	38.5	13.5	83	285
UI39 × 10.2	14VA	48.5	14.5	86	335

Possible primary connections

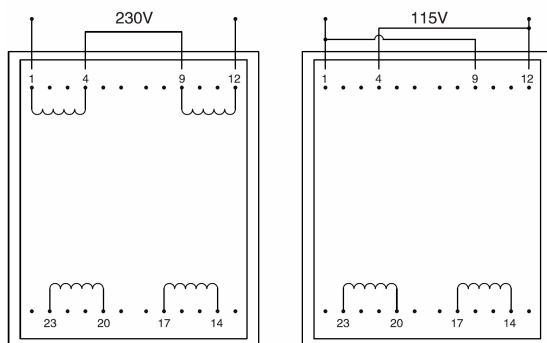

Possible secondary connections

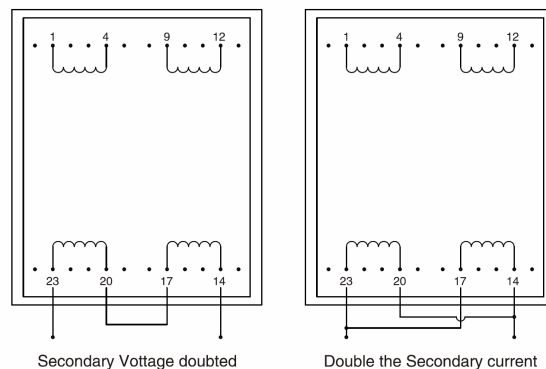

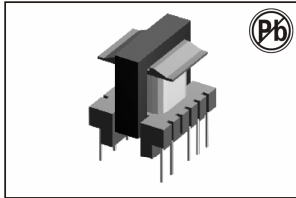

POWER FERRITE TRANSFORMERS 1-6W E16-SINGLE OUTPUT FLYBACK TRANSFORMERS T 74001, 74002 SERIES

FEATURES:

- Primary / Secondary Insulation $\geq 4000V$
- Primary Auxiliary Insulation $\geq 1500V$
- Creepage distances Primary / secondary $\geq 6mm$

OPTIONS:

- Bulk packaging is standard
- Custom design available

COMMON APPLICATIONS:

- AC-DC converters
- DC-DC converters
- Switch Power supplies
- SMPS: Flyback, Forward and Push-pull
- SMPS: Half Bridge and Full Bridge

ELECTRICAL CHARACTERISTICS

Control IC Manufacturer	Control IC P/N	Input voltage	Power	Frequency
Infineon	TDA16831	185 – 265 Vrms	6 w	100 kHz
Motorola	MC33369	85 – 265 Vrms	6 w	100 kHz
Power Integrations	TOP242P	85 – 265 Vrms	6 w	132 kHz
ST Microelectronics	VIPer20	85 – 265 Vrms	6 w	70 kHz
ST Microelectronics	VIPer20	85 – 265 Vrms	3 w	40 kHz

TECHNICAL INFORMATION

- Ambient temperature $< 60^{\circ}C$
- Construction conforms to CEI950, CEI335, CEI61558 for reinforced insulation
- Exclusively uses UL94-VO listed materials

SIZE E16 – SINGLE OUTPUT : 5 or 12V – FLYBACK TRANSFORMER							
Part Number	Output Power max	Windings					Inductance (+/-10%)
			Pins	Turns	Voltage	Current max	
T 74001	6w	Pri	4-6	138	60 – 120 (VOR)	0.35 Apeak	3000 μ H
		Aux	2-1	16	8 – 16 Vdc	0.1 Adc	
		S1	9-10	8	3 – 6 Vdc	1.2 Adc	
T 74002	6w	Pri	4-6	150	60 – 120 (VOR)	0.38 Apeak	3000 μ H
		Aux	2-1	22	8.5 – 17 Vdc	0.1 Adc	
		S1	9-10	24	9 – 18 Vdc	0.5 Adc	

Note: Regulation with auxiliary winding

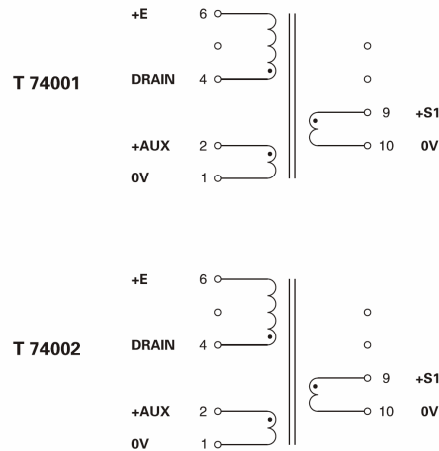

Note: PIN 3 Removed, PCB Drilling Diameter = 1.1mm

PHYSICAL CHARACTERISTICS

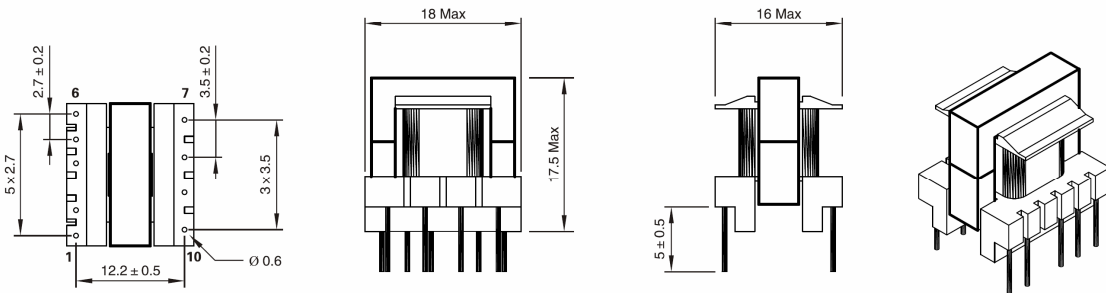

All dimensions in mm

POWER FERRITE TRANSFORMERS 6-12W E16 - 3 OUTPUT FLYBACK TRANSFORMERS T 74015 SERIES

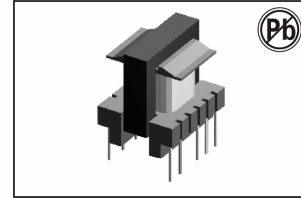

FEATURES:

- Primary / Secondary Insulation \geq 4000V
- Primary Auxiliary Insulation \geq 1500V
- Creepage distances Primary / secondary \geq 6mm

OPTIONS:

- Bulk packaging is standard
- Custom design available

COMMON APPLICATIONS:

- AC-DC converters
- DC-DC converters
- Switch Power supplies
- SMPS: Flyback, Forward and Push-pull
- SMPS: Half Bridge and Full Bridge

ELECTRICAL CHARACTERISTICS

Control IC Manufacturer	Control IC P/N	Input voltage	Power	Frequency
Power Integrations	TNY266	185 – 265 Vrms	10 w	132 kHz
Power Integrations	TNY266	85 – 265 Vrms	8 w	132 kHz
Power Integrations	TOP242P	185 – 265 Vrms	12 w	132 kHz
Power Integrations	TOP242P	85 – 265 Vrms	9 w	132 kHz

TECHNICAL INFORMATION

- Ambient temperature $<$ 50°C
- Construction conforms to CEI950, CEI335, CEI61558 for reinforced insulation
- Exclusively uses UL94-VO listed materials

SIZE E16 - 2 OUTPUTS : 5 & 12V - FLYBACK TRANSFORMER							
Part Number	Output Power max	Windings					Inductance (+/-10%)
			Pins	Turns	Voltage	Current max	
T 74015	12 w	Pri	4-6	120	110 (VOR)	0.5 Apeak	1800 μ H
		Aux	2-1	14	12 Vdc	0.2 Adc	
		S1	9-10	6	5 Vdc	1.5 Adc	
		S2	8-10	17	15 Vdc	0.6 Adc	
		S3	7-10	27	24 Vdc	0.4 Adc	

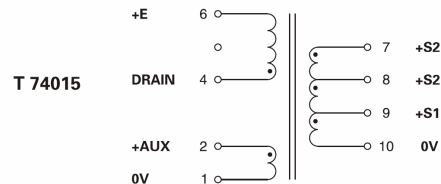

Note: Regulation with auxiliary winding

Note: PIN 3 Removed, PCB Drilling Diameter = 1.1mm

PHYSICAL CHARACTERISTICS

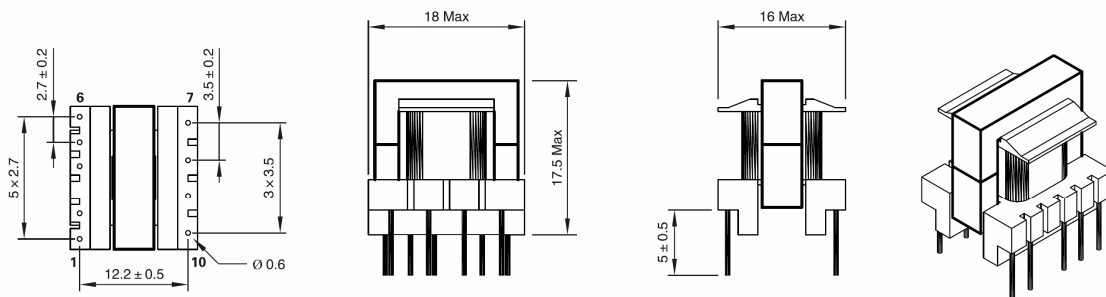

All dimensions in mm

POWER FERRITE TRANSFORMERS 15-30W E25 - 3 or 1 OUTPUT FLYBACK TRANSFORMERS T 74030, 74032 SERIES

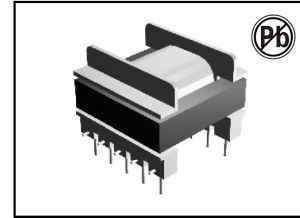

FEATURES:

- Primary / Secondary Insulation \geq 4000V
- Primary Auxiliary Insulation \geq 1500V
- Creepage distances Primary / secondary \geq 6mm

OPTIONS:

- Bulk packaging is standard
- Custom design available

COMMON APPLICATIONS:

- AC-DC converters, • DC-DC converters
- Switch Power supplies
- SMPS: Flyback, Forward and Push-pull
- SMPS: Half Bridge and Full Bridge

ELECTRICAL CHARACTERISTICS

Part No.	Control IC Manufacturer	Control IC P/N	Input voltage	Power	Frequency
T 74030	Fairchild	KA1H0265R	85-265 Vrms	22 w	100 kHz
	Infineon	TDA16832	185-265 Vrms	30 w	100 kHz
	Motorola	MC33371	85-265 Vrms	22 w	100 kHz
	Motorola	MC33371	185-265 Vrms	30 w	100 kHz
	Power Integrations	TOP244P	185-265 Vrms	30 w	132 kHz
	Power Integrations	TOP244Y	85-265 Vrms	25 w	66 or 132kHz
	ST Microelectronics	VIPer50	85-265 Vrms	22 w	70 kHz
ST Microelectronics	VIPer50	185-65 Vrms	30 w	70 kHz	
T 74032	Power Integrations	TOP244P	185-265 Vrms	25 w	132 kHz

TECHNICAL INFORMATION

- Ambient temperature $<$ 50°C
- Construction conforms to CEI 950, CEI 335, CEI 61558 for reinforced insulation
- Exclusively uses UL94-VO listed materials

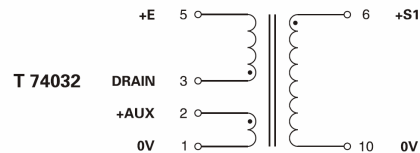
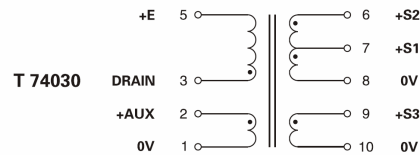

Note: PIN 4 Removed, PCB Drilling Diameter = 1.4mm

SIZE E25 - 3 or 1 OUTPUTS : 5 + 12/12v or 24v - FLYBACK TRANSFORMER							
Part Number	Output Power max	Windings					
			Pins	Turns	Voltage	Current max	Inductance (+/-10%)
T 74030	30 w	Pri	3-5	70	65-130 (VOR)	1.5 Apeak	
		Aux	2-1	8	7-14.5 Vdc	1 Adc	
		S1	7-8	4	3.3-7	3 Adc	
		S2	6-8	9	8-16 Vdc	1.5 Adc	
		S3	9-10	9	8-16 Vdc	1.5 Adc	
T 74032	35w	Pri	3-5	72	65-125 (VOR)	1.1 Apeak	1100 μ H
		Aux	2-1	10	8-16 Vdc	1 Adc	
		S1	6-10	18	15-30 Vdc	1.4 Adc	

Note to 74030 : S2 and S3 can be connected in series or in parallel

PHYSICAL CHARACTERISTICS

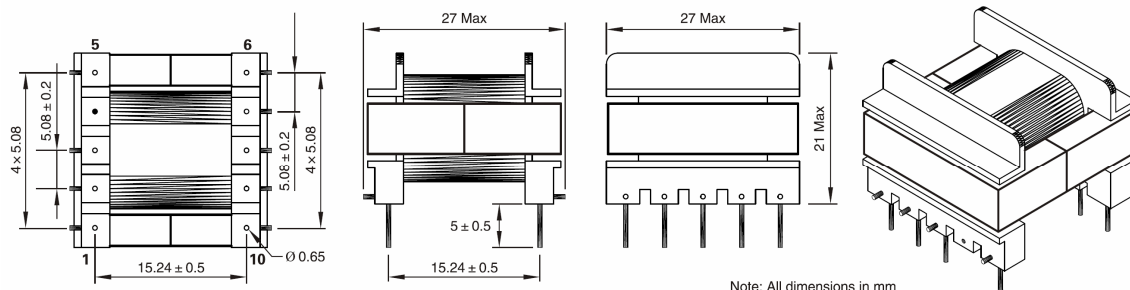

Note: All dimensions in mm

POWER FERRITE TRANSFORMERS 120–180W ETD44 – 4 OUTPUT FLYBACK TRANSFORMERS T 74070 SERIES

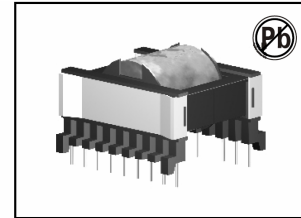

FEATURES:

- Primary / Secondary Insulation $\geq 4000V$
- Primary Auxiliary Insulation $\geq 1500V$
- Creepage distances Primary / secondary $\geq 8mm$

OPTIONS:

- Bulk packaging is standard
- Custom design available

COMMON APPLICATIONS:

- AC–DC converters
- DC–DC converters
- Switch Power supplies
- SMPS: Flyback, Forward and Push–pull
- SMPS: Half Bridge and Full Bridge

ELECTRICAL CHARACTERISTICS

Control IC Manufacturer	Control IC P/N	Input voltage	Power	Frequency
Fairchild	KA2S0965	185–265Vrms	160 w	100 kHz
Infineon	TDA16837	185–265Vrms	160 w	100 kHz
Philips	TEA1566	185–265Vrms	120 w	50 kHz
Power Integrations	TOP248Y	185–265Vrms	180 w	66 or 132 kHz
Power Integrations	TOP249Y	85–265Vrms	120 w	66 kHz

PHYSICAL CHARACTERISTICS

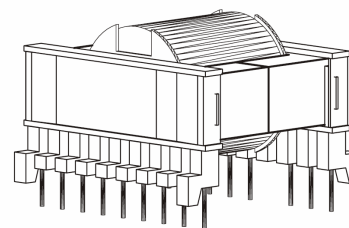
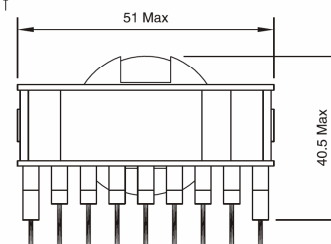
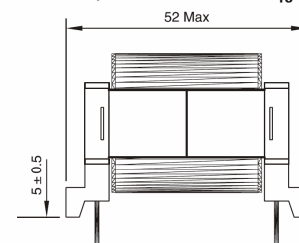
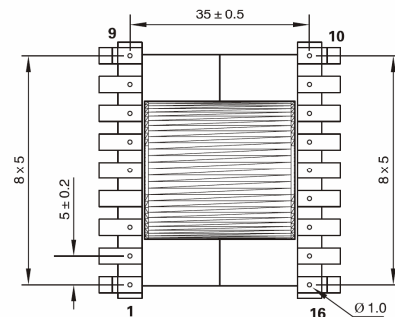

SIZE ETD44 – 4 OUTPUTS : 5 + 12 / 5 + 12v – FLYBACK TRANSFORMER							
Part Number	Output Power max	Windings					
		Pins	Turns	Voltage	Current max	Inductance (+/-10%)	
T 74070	180w	Pri	5–7	38	65–125(VOR)	8 Apeak	300 μ H
		Aux	3–2	4	7–14 Vdc	0.5 Adc	
		S1	16–17	2	3.3–6.5	6 Adc	
		S2	15–17	5	8.5–17 Vdc	5 Adc	
		S3	13–14	2	3.3–6.5	6 Adc	
		S4	12–14	5	8.5–17 Vdc	5 Adc	

Note : S1/S3 or S2/S4 can be connected in series or in parallel

TECHNICAL INFORMATION

- Ambient temperature $< 50^{\circ}C$
- Construction conforms to CEI 950, CEI 335, CEI 61558 for reinforced insulation
- Exclusively uses UL94–VO listed materials

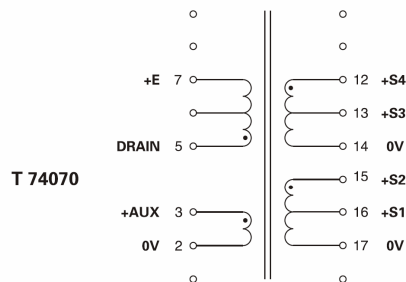

Note: PIN 4 Removed, PCB Drilling Diameter = 1.5mm

Note: All dimensions in mm

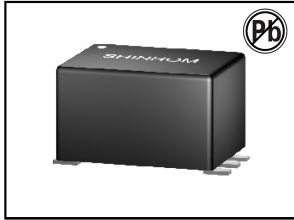

SURFACE MOUNT LINE MATCHING TRANSFORMERS SM-LP-5001 SERIES

FEATURES:

- Subminiature in SMT
- 7.36mm seated height
- Tested at 4600 Vrms, 1minute
- Distortion of only 0.015%
- Vacuum encapsulated
- UL60950 certified
- RoHS compliant *

OPTIONS:

- Tape and reel is standard (400 pcs. per reel)
- Bulk packaging available for smaller quantities
- Custom design available
- Tolerance: 5% is standard, Tighter tolerance available

COMMON APPLICATIONS:

- Modems(V32)
- Laptop Computer
- Telecommunications
- Instrumentation
- PCMCIA

ELECTRICAL CHARACTERISTICS

Nominal Impedance:	600 Ω
Turns Ratio:	1:1
Insertion Loss:	2.0dB max. at 2kHz
Frequency Response:	± 0.25 dB max. 200–4kHz
Return Loss:	24dB min. 200–4kHz *
Balance:	80dB min.
Distortion:	-76dB max. @600Hz, -10dBm
Dielectric Strength:	4600 Vrms for 1 min.
Insulation Resistance:	100M Ω @500V
DC Resistance * *	
Primary:	115 Ω \pm 15%
Secondary:	115 Ω \pm 15%
Shunt Inductance:	3.8H min.
Shunt:	7500 Ω min.
Leakage Inductance:	6mH typ. @1kHz
Power Level:	10dBm
Operating Temperature:	-20°C~+85°C
Storage Temperature:	-40°C~+85°C
Terminal Plating Material:	AgSn

* For use with recommended circuit (BS6305 impedance Class A non-speech or Class B speech)

** SM-LP-5001 is symmetrical, meaning there is no real primary nor secondary winding.

PHYSICAL CHARACTERISTICS

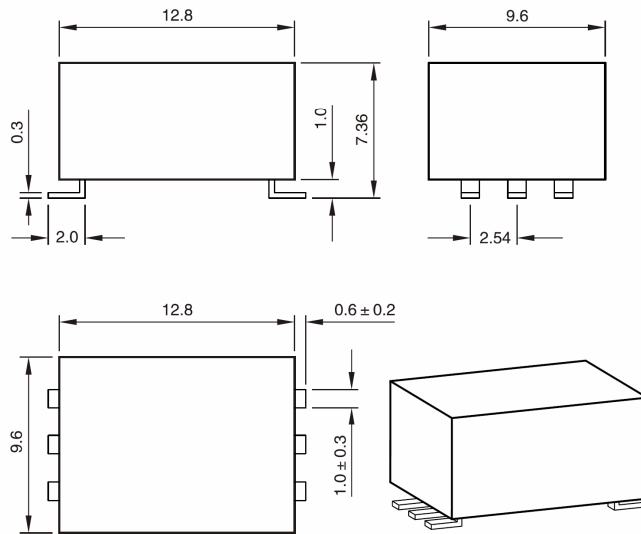

Note: All Dimensions in mm

TECHNICAL INFORMATION

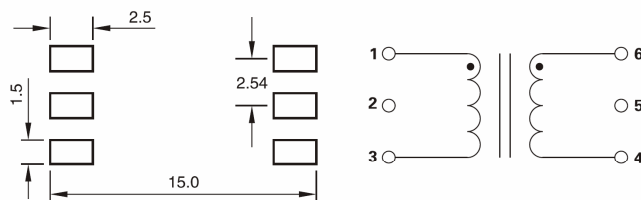

Suggested PCB Layout

Schematic

Note: All Dimensions in mm

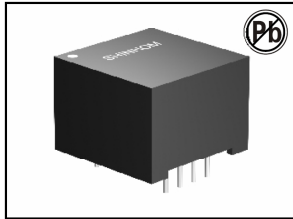

SURFACE MOUNT LINE MATCHING TRANSFORMERS AT 16XX SERIES

FEATURES:

- Fully encapsulated
- Low profile
- High dielectric strength
- Ten models available
- Ex stock
- Competitively priced
- Lead free
- RoHS compliant *

OPTIONS:

- Tape and reel is standard (400 pcs. per reel)
- Bulk packaging available for smaller quantities
- Custom design available
- Tolerance: 5% is standard, tighter tolerance available

COMMON APPLICATIONS:

- Line matching
- Modems
- Fax modems
- Laptop Computer
- Telecommunications
- Instrumentation
- PCMCIA

ELECTRICAL CHARACTERISTICS

Parameters	Unit	Part Number										
		AT1601	AT1602	AT1603	AT1604	AT1605	AT1601A	AT1602A	AT1603A	AT1604A	AT1605A	
Ref. Temperature Data		°C	25	25	25	25	25	25	25	25	25	25
Impedance (min./at 1.0kHz)	Primary	Ω	600	600	600	600 (150,150)	600 (150+150)	600	600	600	600 (150,150)	600 (150+150)
	Secondary	Ω	600	600 (150,150)	600 (150+150)	600 (150,150)	600 (150+150)	600	600 (150,150)	600 (150+150)	600 (150,150)	600 (150+150)
Inductance (min./at 0.2 kHz)	Primary	H	2.8	2.8	2.8	2.8 (0.7,0.7)	2.8 (0.7+0.7)	2.8	2.8	2.8	2.8 (0.7,0.7)	2.8 (0.7+0.7)
	Secondary	H	2.8	2.8 (0.7,0.7)	2.8 (0.7+0.7)	2.8 (0.7,0.7)	2.8 (0.7+0.7)	2.8	2.8 (0.7,0.7)	2.8 (0.7+0.7)	2.8 (0.7,0.7)	2.8 (0.7+0.7)
DC-Resistance (Typical/ ± 10%)	Primary	Ω	66	66	66	66 (33,33)	66 (33+33)	90	90	90	90 (45,45)	90 (45+45)
	Secondary	Ω	66	66 (33,33)	66 (33+33)	66 (33,33)	66 (33+33)	90	90 (45,45)	90 (45+45)	90 (45,45)	90 (45+45)
Turns Ratio(≤ ± 2%)		-	1:1	1:1	1:1	1:1	1:1	1:1	1:1	1:1	1:1	1:1
Winding Configurations		-	-	one winding centre tapped	one winding split	both windings centre tapped	both windings split	-	one winding centre tapped	one winding split	both windings centre tapped	both windings split
Insertion Loss (at 2.0kHz)		dB	≤1.5					≤2.0				
Return Loss Transformer (0.2–4.0kHz) In Networks		dB	≥10.0 ≥21.0					≥8.0 ≥20.0				
Shunt Loss (Typical)		kΩ	9.0					9.0				
Frequency Response (Typ./0.2–3.5kHz)		dB	-0.3					-0.5				
Wide Band Response(0.2–10kHz)		dB	-2.5					-4.5				
Power Level		dBm	-45.0~+3.0					-43.0~+3.0				
Longitudinal Balance(0.3–4.0kHz)		dB	-80.0					-70.0				
Distortion(0 dB/at 1.0kHz)		%	≤0.1					≤0.25				
Leakage Induction(Typical)		mH	14.0					14.0				
Dielectric Strength(P/S)		kVDC	6.5					6.5				
Temperature Range	Operation	°C	-10~+60					-10~+60				
	Storage	°C	-20~+70					-20~+70				
Specifications Met			BS 6240: Construction and flammability (UL 94 VO) BS 6310: Isolation BS 6305: Return loss (1982/paragraph 4.3.2.2/b)					CCITT: Rec. T/CD 1-1 (Sept. 1982)				

TELECOM TRANSFORMERS RM & POT SERIES

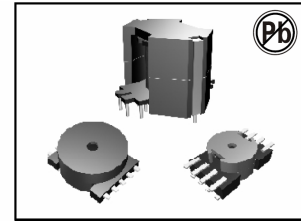

FEATURES:

- High inductance.
- Low leakage inductance
- Low interwind capacitance
- Compact size and Surface-mounted
- Designed to meet UL, CSA, VDE, BABT safety standard

OPTIONS:

- Tape and reel is standard
- Bulk packaging available for Smaller quantities
- Custom design available
- Tolerance: 5% is standard, Tighter tolerance available
- RM 4, 5, 6, 7, 8, 10, 12, 14 available
- POT 3,2, 4,5, 6, 7, 9, 11, 14, 18, 22, 26, 30, 36, 42, 48 available

COMMON APPLICATIONS:

- Modem
- Fax machine, Hub
- ISDN, ADSL, HDSL, PABX
- Other telecommunication facilities etc
- Switching power supplies
- AC-DC, DC-DC converters

ELECTRICAL CHARACTERISTICS

Part No.	Inductance(10kHz/0.1V Typ)	Turn Ratio	DCR(Ω max)	Hi-pot (Pri-Sec)	Schematic
RM4	45.2mH \pm 35%(3-4)	1:1(2-3:5-6)	2.5:2.5(2-3:5-6)	500VDC	A
RM5	43.5mH \pm 6%(1-3:3-4)	1:1(1-3:4-2)	4.6:4.6(1-3:4-2)	1000VDC	B
RM6	20mH \pm 6%(2-3 tie 6+5)	1:1(2-5:6-3)	4.0:4.0(2-5:6-3)	850VDC	C
RM8	3.0mH \pm 6%(8-6 tie 5+7)	5.24:1(8-6:1-12 tie 5-7)	1.7:1.7:0.042(8-5:7-6:1-12)	2500VAC	D
RM12	140 μ Hmin(3-1=2-11)	1:1:2:2(3-1:12-11:5-6:7-8)	0.012:0.05(3-1=12-11:5-6:7-8)	500VDC	E
POT14	450 μ H \pm 25%(4-1)	3.75:1(4-1:6-8)	0.04:0.012:0.012(4-3:5-7:6-8)	1250VDC	F
POT23	15.5mH \pm 10%(1-4 tie 2+3)	1:0.6(1-4:7-9 tie 2+3)	13:7.8(1-4:7-9 tie 2+3)	1500DC	G

TECHNICAL INFORMATION

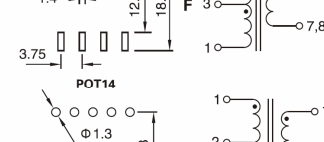
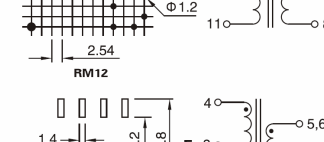
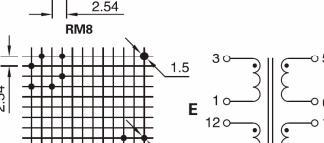
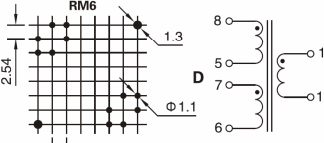
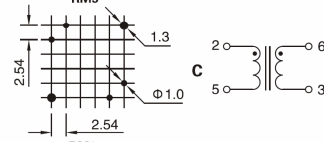
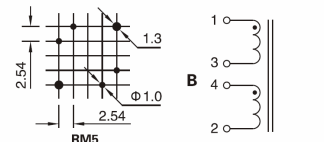
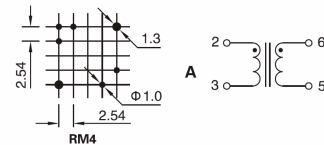

Note: All Dimensions in mm

PHYSICAL CHARACTERISTICS

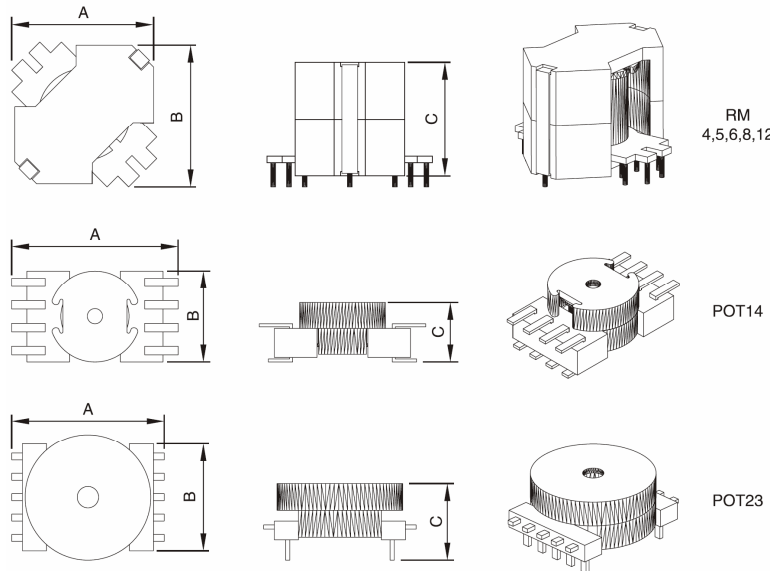

Dimensions(mm)

Part No.	RM4	RM5	RM6	RM8	RM12	POT14	POT23
A	10.5max	13.5max	16.6max	22.0max	31.7max	21.0max	24.4max
B	10.5max	13.5max	16.6max	22.0max	31.7max	15.0max	23.5max
C	11.0max	11.5max	12.7max	17.5max	25.4max	9.0max	11.6max

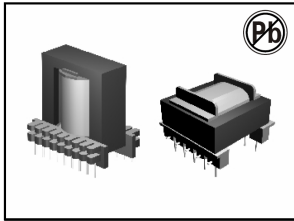

SWITCHING TRANSFORMERS TEE, TEI SERIES

FEATURES:

- Possessing of high permeability
- High saturation flux density
- Low loss, at 100°C the power loss goes bottom

OPTIONS:

- Bulk packaging is standard
- Custom design available

COMMON APPLICATIONS:

- Drive transformers
- Main transformers
- Smoothing chokes
- General purpose use

ELECTRICAL CHARACTERISTICS

Part No.	Type	No. of Terminal pins	Dimensions(mm)						Max. output (VA)
			Max	Max	Max	± 0.3	± 0.5	± 0.1	
			A	B	C	D	E	F	
TEI 8.3-A	V	6	8.5	8.5	9.0	2.5	6.0	0.5	3
TEE 8.3-B	H	6	8.5	8.5	7.0	2.5	6.0	0.5	3
TEE 8.3-C	H	4	8.5	9.5	9.0	5.0	6.8	0.5	3
TEI 10-A	V	8	10.5	11.0	11.0	2.5	8.0	0.5	5
TEI 10-B	H	8	11.0	13.0	10.5	2.5	10.5	0.5	5
TEI 10-C	H	4	10.0	9.5	10.0	5.0	6.8	0.5	5
TEI 12.5-A	V	10	13.0	13.0	10.0	2.5	7.5	0.6	8
TEE 12-A	H	4	12.5	11.0	12.5	8.0	9.0	0.6	8
TEE 13-A	V	10	13.5	13.0	12.0	2.5	8.7	0.6	9
TEI 14-A	V	6	14.5	14.5	13.0	3.5	11.0	0.6	15
TEE 16-A	V	6	16.5	14.5	13.0	3.0	9.0	0.6	25
TEE 16-B	H	8	16.5	14.5	15.0	3.0	11.0	0.6	25
TEE 16-C	H	8	16.5	14.5	15.0	3.5	12.0	0.6	25
TEE 16-D	V	10	16.5	13.5	14.5	3.25	10.5	0.6	25
TEE 16-F	H	10	16.5	19.0	14.0	3.2	15.5	0.8	25
TEEL 16-A	V	10	22.0	16.5	30.0	4.0	10.3	0.6	25
TEE 19-A	V	6	20.0	18.0	18.0	4.1	14.0	0.7	35
TEE 19-B	V	6	20.0	16.0	18.0	4.7	11.6	0.6	35
TEE 19-C	H	8	20.0	18.0	16.5	3.8/5	12.5	0.7	35
TEEL 19-A	V	8	20.0	20.5	32.0	3.8/4.8	15.0	0.8	35
TEEL 19-B	H	6	19.5	32.0	13.0	5	24.2	0.8	35
TEEL 19-C	V	10	23.0	16.5	32.0	4	10.0	0.8	35
TEE 20-A	H	8	20.5	19.0	13.0	5	15.0	0.8	35
TEE 22-A	V	10	22.5	16.5	20.0	4	10.2	0.8	45
TEE 22-B	V	8	22.5	17.0	20.0	5	12.4	0.8	45
TEE 22-C	H	9	22.5	24.5	16.5	3.5/5	17.2	0.8	45
TEE 25-A	V	8	25.5	18.0	22.0	5	12.4	0.8	65
TEE 25-B	V	10	26.0	20.5	22.0	5	15.2	0.8	65
TEE25-C	H	10	27.0	24.0	24.0	4.0/5	14.6	0.8	65
TEEL 25-A	H	14	27.5	33.5	21.0	4.0	27.1	0.8	65

Part No.	Type	No. of Terminal pins	Dimensions(mm)						Max. output (VA)
			Max	Max	Max	± 0.3	± 0.5	± 0.1	
			A	B	C	D	E	F	
TEL 25-B	V	14	27.5	21.0	35.0	4.0	15.0	0.8	65
TEI 28-A	V	12	29.5	25.0	24.0	5.0	17.5	0.8	100
TEI 28-B	V	10	28.5	25.0	35.0	5.0	20.0	0.8	100
TEI 28-C	H	8	28.5	25.0	25.0	5.0	17.5	0.8	100
TEI 30-A	V	10	31.0	22.0	26.0	5.0	17.6	0.8	155
TEI 30-B	V	12	31.0	26.0	26.0	5.0	20.0	0.8	155
TEE 30-A	H	10	30.5	30.0	20.5	5.0	25.0	0.8	155
TEE 30-B	H	12	30.5	30.0	20.5	5.0	25.0	0.8	155
TEI 33-A	V	14	34.0	28.0	30.0	5.0	22.5	0.8	200
TEI 33-B	V	12	34.0	28.0	30.0	5.0	22.5	0.8	200
TEI 33-C	V	16	39.0	29.0	30.0	5.0	22.5	0.8	200
TEE 35-A	H	12	38.0	30.0	26.0	3.8/5.1	22.0	0.8	215
TEE 35-B	V	10	35.5	26.0	28.0	5.0	20.0	0.8	215
TEE 35-C	V	14	35.5	26.0	28.0	5.0	20.0	0.8	215
TEEL 35-A	V	15	36.5	27.5	50.0	5.0	22.5	0.8	215
TEI 35-A	V	12	35.5	28.5	29.0	5/7.5	20.0	1.0	215
TEI 40-A	V	12	40.5	29.0	32.0	5.0	22.5	0.8	345
TEI 40-B	H	12	40.5	37.0	27.0	5.0	28.2	1.0	345
TEI 40-C	V	16	42.0	28.0	35.0	5.0	22.5	0.8	345
TEI 40-D	H	14	40.5	35.0	29.0	5.0	25.8	0.8	345
TEE 42-A	H	16	44.5	42.0	41.5	5.0	34.0	1.0	400
TEE 42-B	H	12	47.0	42.0	39.5	5/7.5	33.0	1.0	400
TEE 42-C	V	18	46.0	32.5	46.0	5.0	27.5	1.0	400
TEE 42-D	V	12	46.0	42.5	37.0	7.4	36.4	1.0	420
TEE 42-E	V	12	43.0	40.5	45.0	5.0	32.5	1.0	420
TEE 42-F	H	17	43.0	47.0	45.0	2.5/5	37.7	1.0	420
TEE 42-G	V	18	46.0	38.0	47.0	5.0	30.0	1.0	420
TEE 50-A	V	18	51.0	40.0	40.0	5.0	30.5	1.0	500
TEE 55-A	H	20	56.0	55.0	50.5	5/7.5	45.2	1.0	814

Note: The output power is only for forward model and the frequency at 100kHz

PHYSICAL CHARACTERISTICS

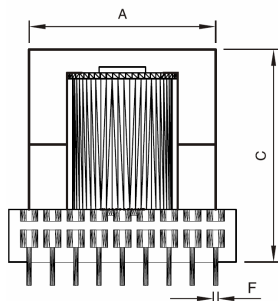

Type V

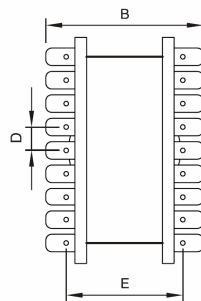

Type H

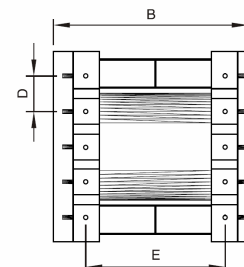
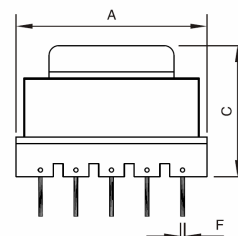

SWITCHING TRANSFORMERS TPQ SERIES

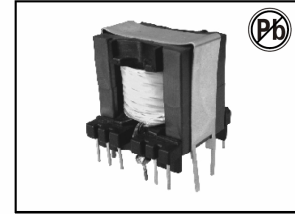

FEATURES:

- Design in the fittest shape
- Applied in the power: (50W–1kW)100kHz
- Cut down installation cubage with multi-pluge and bobbins, easily wire connection to meet the request
- Low leakage

OPTIONS:

- Bulk packaging is standard
- Custom design available

COMMON APPLICATIONS:

- Drive transformers
- Main transformers
- Smoothing chokes
- Switching power supplies
- AC-DC, DC-DC converters

ELECTRICAL CHARACTERISTICS

Part No.	Type	No. of Terminal pins	Dimensions(mm)							Max. output (VA)
			Max	Max	Max	± 0.3	± 0.4	± 0.5	± 0.1	
			A	B	C	D	E	F	G	
TPQ 2020-A	V	14(6+8)	24.0	24.0	22.0	3.8/2.5	5.1	20.3	0.6	92
TPQ 2620-A	V	12	28.0	32.0	22.0	3.8	7.6	25.4	0.6	170
TPQ 2620-B	V	12	28.0	32.0	21.0	3.8	7.6	25.4	0.6	170
TPQ 2625-A	V	12	28.5	31.0	28.0	3.8	7.5	25.5	0.7	195
TPQ 3220-A	V	12	33.0	35.0	24.0	5.0	7.5	30.0	0.8	232
TPQ 3220-B	V	12	33.0	36.0	22.0	5.1	7.6	30.5	0.8	232
TPQ 3225-A	V	12	35.5	35.0	27.0	5.0	7.4	30.0	0.8	280
TPQ 3230-A	V	12	33.0	36.0	32.0	5.05	7.6	30.3	0.8	331
TPQ 3535-A	V	12	37.0	41.0	38.5	5.0	10.0	35.0	0.8	452
TPQ 4040-A	V	12	41.0	44.0	43.0	5.0	15.1	38.0	0.8	596
TPQ 5050-A	V	12	52.0	53.0	54.0	7.62	15.24	45.72	1.2	1045

Note: The output power is only for forward model and the frequency at 100kHz

PHYSICAL CHARACTERISTICS

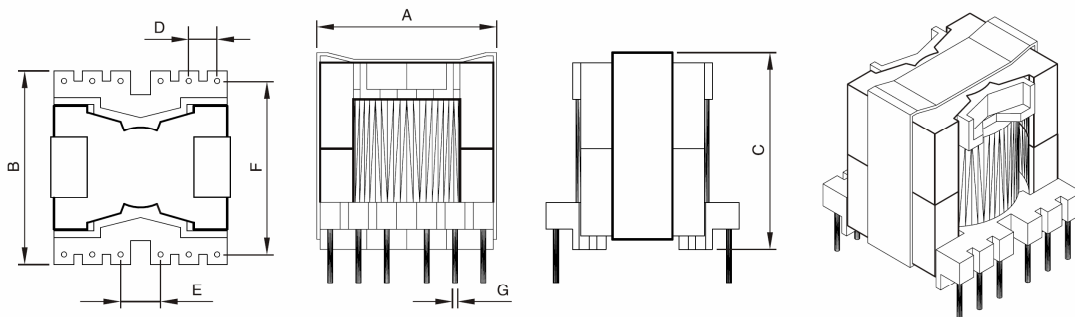

Type V

THROUGH-HOLE CURRENT SENSOR TRANSFORMER ACST010-013 SERIES

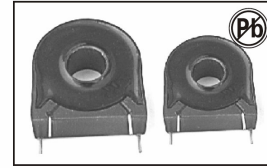

FEATURES:

- Low profile, directly to PCB.
- PBT 94V0 Case burn-resistant epoxy resin, stable.

OPTIONS:

- Bulk is standard
- Custom design acceptable

COMMON APPLICATIONS:

- AC energy Meter Power transducer RTU
- Protection current transformer
- AC kilowatt hour meter
- Electronical monitoring system

ELECTRICAL CHARACTERISTICS:

Performance&Specification for High Precision Current Test							Performance&Specification for Protection Precision Current Test						
Part Number	Rated primary current(A)	Max primary current(A)	Rated secondary current(mA)	Current ratio	Output ratio (Ω)	Accuracy class	Part Number	Rated primary current(A)	Max primary current(A)	Rated secondary current(mA)	Resistance load (Ohm)	Output ratio (Ω)	Accuracy class
ACST010A/5	5	40	2.5	2000:1	100	0.2,0.5	ACST010B	5	60	5	100	0.5	0.5,1.0
ACST010A/10	10	40	4	2500:1	100	0.2,0.5	ACST010B	10	60	10	100	1.0	0.5,1.0
ACST010A/20	20	40	10	2000:1	100	0.1,0.2,0.5	ACST010B	15	60	15	100	1.5	0.5,1.0
ACST011A/10	10	60	4	2500:1	100	0.1,0.2,0.5	ACST011B	20	60	20	100	2.0	0.5,1.0
ACST011A/20	20	60	10	2000:1	100	0.1,0.2,0.5	ACST011B	25	75	25	100	2.5	0.5,1.0
ACST011A/40	40	60	20	2000:1	100	0.1,0.2,0.5	ACST011B	30	75	30	100	3.0	0.5,1.0
ACST012A/60	60	120	24	2500:1	100	0.1,0.2,0.5	ACST012B	40	75	40	100	4.0	0.5,1.0
ACST012A/80	80	120	32	2500:1	100	0.1,0.2,0.5	ACST012B	50	125	50	100	5.0	0.5,1.0
ACST012A/120	120	120	48	2500:1	100	0.1,0.2,0.5	ACST012B	60	125	60	100	6.0	0.5,1.0
ACST013A/100	100	200	40	2500:1	100	0.1,0.2,0.5	ACST013B	75	125	75	100	7.5	0.5,1.0
ACST013A/100	100	200	50	2000:1	100	0.1,0.2,0.5	ACST013B	100	250	100	100	10.0	0.5,1.0
ACST013A/200	200	200	80	2500:1	100	0.1,0.2,0.5	ACST013B	150	250	150	100	15.0	0.5,1.0

TECHNICAL INFORMATION & PHYSICAL CHARACTERISTICS:

- Working Frequency range 20Hz~400Hz
- Insulation resistance: 500V DC >100MΩ
- Hi-Pot : 4000V 1mA 60S
- Temperature range: -25°C to +85°C
- Storage Temperature: -40°C to +105°C
- Resistance to soldering heat: 260°C for 10 seconds
- Marking: Part number and date code

Note: All specifications subject to change without notice.

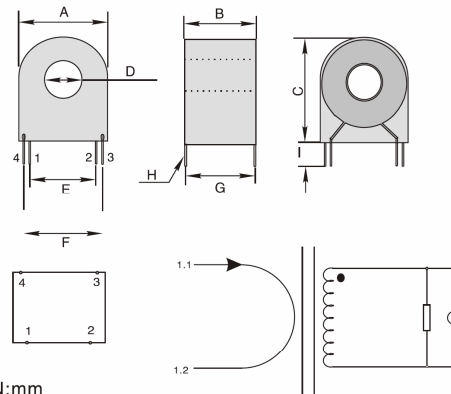

DIMENSIONS IN:mm

	A	B	C	D	E	F	G	H	I
ACST010	23.5	12.5	25.0	7.0	15.0	18.5	10.5	1.0	6.0
ACST011	26.0	17.0	29.0	9.0	15.0	18.5	15.0	1.0	6.0
ACST012	37.0	14.0	39.0	13.0	25.0	32.5	11.0	1.0	6.0
ACST013	49.0	20.0	54.0	18.5	29.5	37.0	17.5	1.0	6.0

Note: All specifications subject to change without notice.

HIGH FREQUENCY CURRENT SENSING TRANSFORMER ACST SETRIES

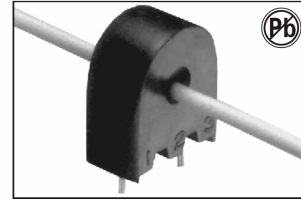

FEATURES:

- Meets UL94-V0 Requirements
- Precise Current Sensing

OPTIONS:

- Bulk Packaging is Standard
- Custom Design Available
- Thru Hole Available

COMMON APPLICATIONS:

- SMPS Control Circuits
- Current Sensing
- Switching power regulators
- Pulse current test

STANDARD SPECIFICATIONS @250C

Part Number	SCHEMATIC	TURNS (± 1% Max)	OCL (mH Min)	DCR (Ω Max)	ET (V- μ SEC-Min)
ACST-001	2A	50	5.0	0.7	150
ACST-002	2A	100	20.0	1.40	300
ACST-003	2A	200	80.0	4.50	600
ACST-004	2A	300	180.0	11.0	900
ACST-005	2B	50CT	5.0	0.7	150
ACST-006	2B	100CT	20.0	1.40	300
ACST-007	2B	200CT	80.0	4.50	600
ACST-008	2B	300CT	180.0	11.0	900
ACST-E51	3	100	2.0	5.50	120
ACST-E52	3	125	3.0	6.50	130

TECHNICAL INFORMATION & PHYSICAL CHARACTERISTICS

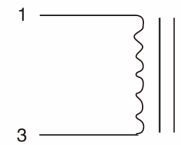
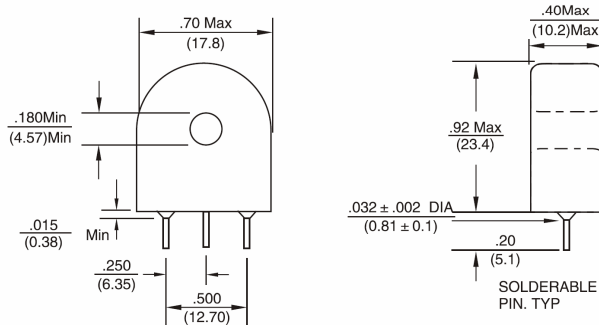

FIG. 2A

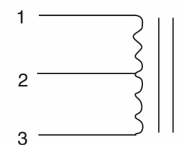

FIG. 2B

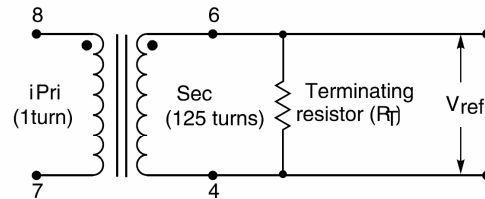
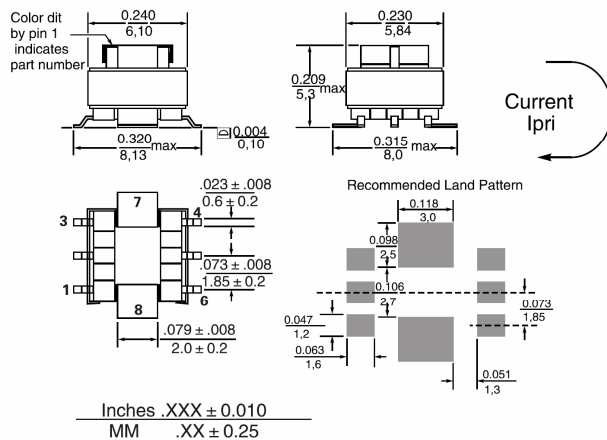
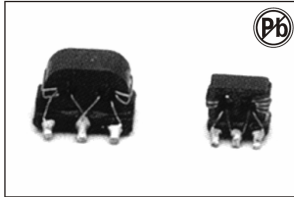

FIG. 3

- Working Frequency range: 10KHz~1MHz
 - Testing Frequency: 10 KHz 0.1VRMS
 - Hipot: 2000VAC, Primary to Secondary
 - Maximum Sensing Current: 20A p-p
 - All secondary measurements are in pins 1-3
 - Soldering methods: Wave, Reflow
 - Operating Temperature: 0°C to 85°C
 - Storage Temperature: -25°C to 85°C
- Note: All specifications subject to change without notice



RF Transformers

RF 5S,5SL SERIES

FEATURES:

- Pair wire coil for high stability.
- Base pin terminal treated
- Excellent Frequency Response
- Low Profile Low Cost

OPTIONS:

- Bulk Packaging is Standard
- Custom design available
- dip Available

APPLICATIONS:

- Double balance mixers, broad-band impedance transformers
- Directional Couplers for Mixers
- Matching Power Combining and Splitting
- Step-Top box and cable modem

STANDARD SPECIFICATIONS

	Part Number	Number of Turns per Winding	Operating Frequency Range	Insertion Loss	Fig
Double Balanced Mixer	RF-5S-1012	1	50MHz-400MHz	10dB max.	1
	RF-5S-1013	2	100MHz-1.0GHz	6dB max.	1
	RF-5S-1003	3	8MHz-800MHz	3.5dB max.	1
	RF-5S-1008	4	6MHz-600MHz	2.5dB max.	1
	RF-5S-1011	5	5MHz-500MHz	2dB max.	1
	RF-5S-1005	2	400MHz-1.3MHz	4dB max.	1
Frequency Mixer	RF-5S-1085	1	—	3dB max.	2
	RF-5S-1052	2	9MHz-350MHz	3dB max.	2
	RF-5S-1024	3	3.5MHz-470GHz	3dB max.	2
	RF-5S-1086	4	2.2MHz-400MHz	3dB max.	2
	RF-5S-1087	5	1.5MHz-300MHz	3dB max.	2
Power Divider /Combiner	RF-5S-1014		20MHz-600MHz	IN to OUT-1,2 4.5dB max. OUT-1 to OUT-2 (ISOLATION) 10dB min.	6
Directional Coupler	RF-5S-1015	4	6MHz-600MHz	IN to OUT-1,3dB max. IN to OUT-2,11dB -14dB	7
	RF-5S-1006	5	6MHz-600MHz	IN to OUT-10,9dB max. IN to OUT-2,13dB -16dB	7
	RF-5S-1007	6	6MHz-600MHz	IN to OUT-10,8dB max. IN to OUT-2,15dB -17dB	7
Double Balanced Mixer	RF-5SL-1001	2	30MHz-850MHz	3dB	1
	RF-5SL-1002	3	6.5MHz-1000MHz	3dB	1
	RF-5SL-1003	4	3.5MHz-1600MHz	3dB	1
	RF-5SL-1004	5	2.5MHz-1500MHz	3dB	1
Frequency Mixer	RF-5SL-1027	1	—	3dB	2
	RF-5SL-1028	2	8MHz-550MHz	3dB	2
	RF-5SL-1029	3	3.5MHz-500MHz	3dB	2
	RF-5SL-1030	4	2MHz-370MHz	3dB	2
	RF-5SL-1037	1	—	3dB	2
	RF-5SL-1038	2	500MHz-850MHz	3dB	2
	RF-5SL-1039	3	240MHz-500MHz	3dB	2
Balun Transformer	RF-5SL-1040	4	85MHz-380MHz	3dB	2
	RF-5SL-1048	1 ₁₂	5.5MHz-850MHz	3dB	3
	RF-5SL-1049	2 ₁₂	2.5MHz-2200MHz	3dB	3
	RF-5SL-1050	3 ₁₂	1.2MHz-1700MHz	3dB	3
	RF-5SL-1051	4 ₁₂	0.8MHz-1400MHz	3dB	3
Balun Transformer	RF-5SL-1078	5 ₁₂	0.6MHz-1300MHz	3dB	3
	RF-5SL-1053	1 ₁₂	160MHz-2200MHz	3dB	4
	RF-5SL-1017	2 ₁₂	55MHz-1700MHz	3dB	4
	RF-5SL-1054	3 ₁₂	30MHz-1400MHz	3dB	4

Note: 1. K= ± 10%, M= ± 20%

PHYSICAL CHARACTERISTICS

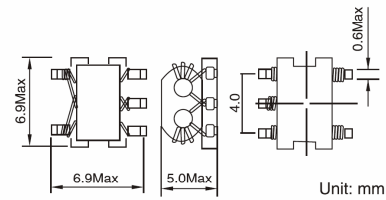

Pin Connections

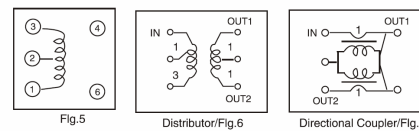
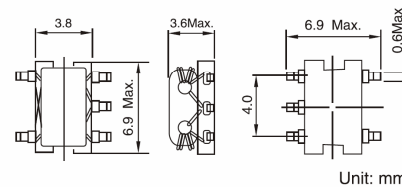
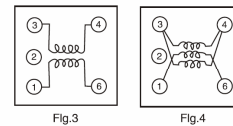
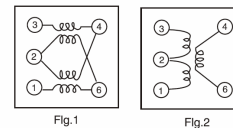

TECHNICAL INFORMATION:

- Soldering methods: Wave, Reflow
- Operating Temperature: 0°C to 70°C
- Storage Temperature: -55°C to 125°C

Note: All specifications subject to change without notice.

ADSL CENTRAL OFFICE POTS SPLITTER ADSL-205,213 SERIES

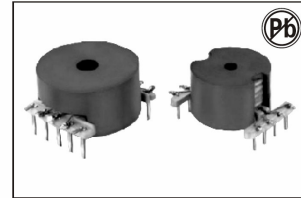

FEATURES:

- Excellent Longitudinal Balance
- DC Current up to 100mA

OPTIONS:

- Bulk Packaging is Standard
- Custom design available
- SMT Available

COMMON APPLICATIONS:

- ADSL Central Office
- POTS Filter

STANDARD SPECIFICATIONS

Part Number	Turns Ratio	OCL (mH)	DCR (Ω Max)	Schematic	Package
ADSL-205	1CT:1	4.0 \pm 5%	3.00	1	A
ADSL-206	1CT:1	3.0 \pm 5%	2.50	1	A
ADSL-207	1CT:1	2.25 \pm 10%	2.25	1	A
ADSL-208	1CT:1	1.425 \pm 10%	2.25	1	A
ADSL-209	1CT:1	1.65 \pm 10%	2.25	1	A
ADSL-210	1CT:1	1.35 \pm 10%	2.25	1	A
ADSL-211	1:1	4.0 \pm 5%	3.00	2	B
ADSL-212	1:1	10.0 \pm 5%	5.00	2	B
ADSL-213	1:1:1:1	0.6 \pm 5%	2.00	3	B

Note: 1. K = \pm 10%, M = \pm 20%

TECHNICAL INFORMATION & PHYSICAL CHARACTERISTICS

- Soldering methods: Wave, Reflow
- Operating Temperature: 0°C to 70°C
- Storage Temperature: -55°C to 125°C

Note: All specifications subject to change without notice.

Hipot: 1500VRMS.
Inductance Measured at 1KHz, 100mA

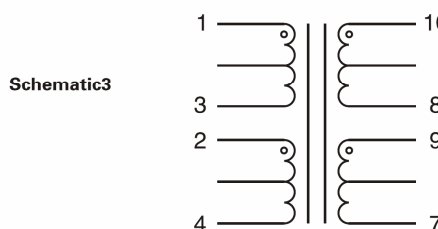
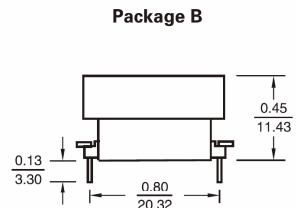
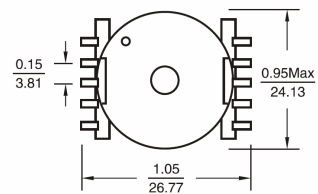
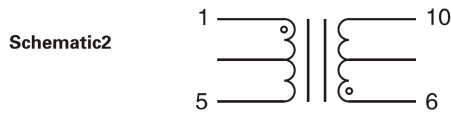
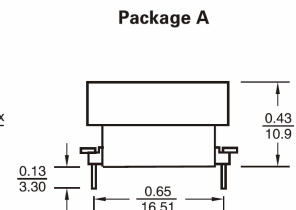
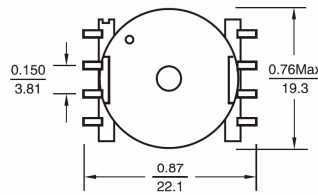
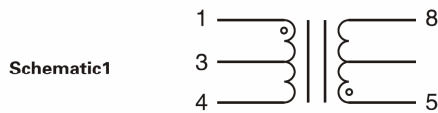

Dimensions: Inches (mm)

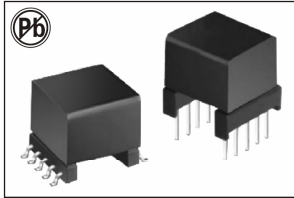

ADSL TRANSFORMERS

ADSL-100 SERIES

FEATURES:

- High Frequency Design
- Excellent THD
- High Reliability

OPTIONS:

- Tape & Reel is Standard
- Custom design available

COMMON APPLICATIONS:

- ADSL VDSL Router
- Analog Devices, Alcatel, Globespan.
- Central Office/Customer Premise

STANDARD SPECIFICATIONS

Part Number	Application	Turns Ratio $\pm 2\%$ Line to Chip	OCL (mH $\pm 10\%$) Line Side	L_L (μ H Max)	Longitudinal Balance (dB Min)	DCR (Ω Max.) Line Side	THD (dB Min)	SCH	Applicable IC
ADSL-101	CPE	1:1	5.0 (1)	15 (2)	40(25KHz-1.1MHz)	3.0	80@30KHz	1	AD20msP910/918
ADSL-102	CPE	1:1	0.48 (1)	10 (2)	40(30KHz-1.1MHz)	1.0	72@10KHz	1	MTK-20/40
ADSL-102A	CO	1:1	0.41 (1)	6.5 (2)	40(30KHz-1.1MHz)	0.6	72@20KHz	1	MTK-20/40
ADSL-103	CPE	2:1	0.43 (3)	10 (4)	40(25KHz-1.1MHz)	0.45	80@100KHz	2	G7000
ADSL-105	CPE	1:1	0.407 (1)	9 (2)	40(25KHz-1.1MHz)	0.66	80@100KHz	1	EL-1501

Inertion Loss: 0.5dB max Inductance measured @10KHz 0.1 VRMS Hipot: 1500 VRMS

Remark: Add "S" after Part No. for SMT package

Example: ADSL-101S for SMT Package: Package B

Notes:

1. Measure inductance at pin 1-4 with pin 2-3 shorted.
2. Measure leakage inductance at pin 1-4 with 2-3 shorted, and 7-8-9-10 shorted.
3. Measure inductance at pin 1-5 with pin 2-4 shorted.
4. Measure leakage inductance at pin 1-5 with 2-4 shorted, and pin 6-9-7-10 shorted.

TECHNICAL INFORMATION & PHYSICAL CHARACTERISTICS

- Soldering methods: Wave, Reflow
- Operating Temperature: 0°C to +70°C
- Storage Temperature: -55°C to 125°C

Note: All specifications subject to change without notice.

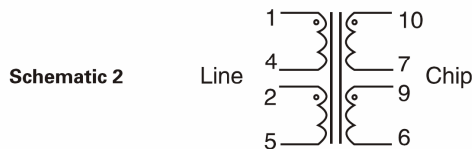
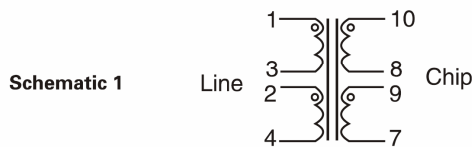

Recommended Pad Layout

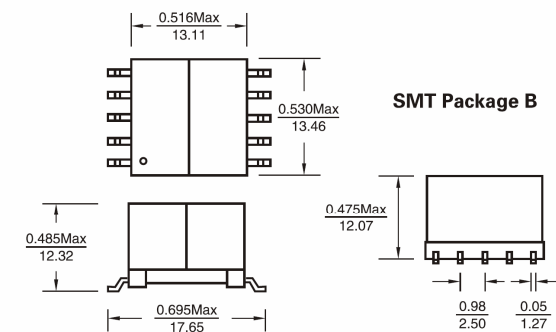
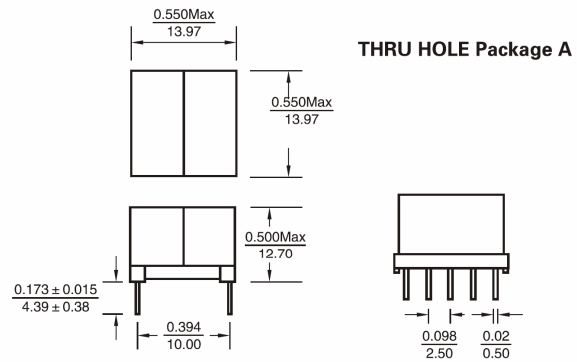
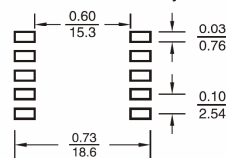

Dimensions: Inches/mm

SMD LOW PROFILE SWITCHING TRANSFORMER

SPT SERIES

SPT-01,02,03

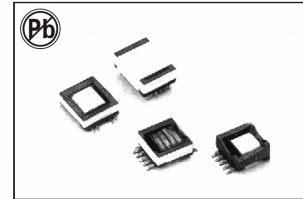

FEATURES:

- Multiple Combination
- Series Mode or Parallel Mode
- Low Profile

OPTIONS:

- Bulk Packaging is Standard
- Custom Design Available
- Thru Hole Available

COMMON APPLICATIONS:

- SMPS DC-DC converter
- CMC, Differential
- Flyback, Boost, Buck
- ADSL/VDSL
- Switching power supplier

STANDARD SPECIFICATIONS @250C

Part Number		L (μH) ± 20%	Leakage (μH) Typ.	DCR Max (Ω) Max	1rms Typ (mA) Typ.
SPT-01 EFD-17 Package	SPT-01-3R8	3.8	0.08	0.06	1.8
	SPT-01-5R0	5.0	0.08	0.06	1.8
	SPT-01-6R2	6.2	0.08	0.06	1.8
	SPT-01-11R5	11.5	0.08	0.06	1.8
	SPT-01-700	70	0.08	0.06	1.8
SPT-02 EFD-15 Package	SPT-02-3R8	3.8	0.06	0.07	1.5
	SPT-02-4R5	4.5	0.06	0.07	1.5
	SPT-02-6R8	6.8	0.06	0.07	1.5
	SPT-02-11R3	11.3	0.06	0.07	1.5
	SPT-02-630	63	0.06	0.07	1.5
SPT-03 EFD-20 Package	SPT-03-3R5	3.5	0.11	0.05	2.1
	SPT-03-4R5	4.5	0.11	0.05	2.1
	SPT-03-5R3	5.3	0.11	0.05	2.1
	SPT-03-100	10	0.11	0.05	2.1
	SPT-03-770	77	0.11	0.05	2.1

TECHNICAL INFORMATION & PHYSICAL CHARACTERISTICS

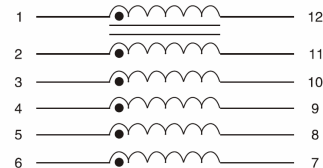
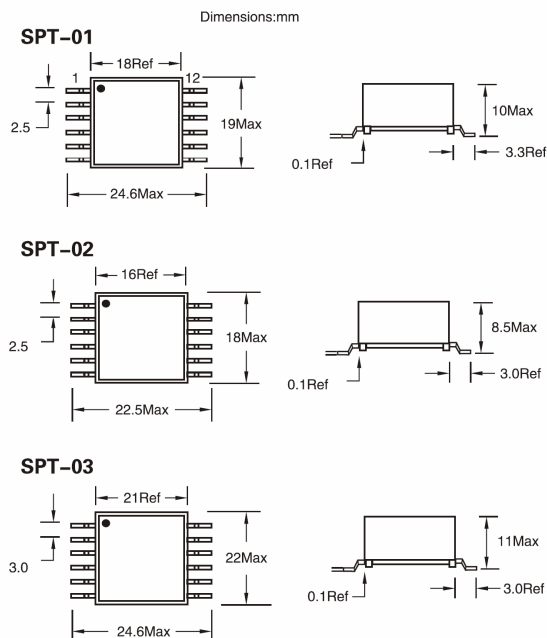

- Inductance measure at Pin 1-2, 100KHz 0.1VRms.
 - DCR measure at individual winding
 - Leakage measure at pin 1-12 with all other windings shorted
 - Insulation Resistance: 500 VDC, 1KM Ohm min.
 - Turns ratio: 1:1:1:1:1:1
 - Soldering temperature: 260°C for 4 ± 1 seconds
 - Operating temperature: 0°C to 70°C
 - Storage Temperature: -25°C to 85°C
 - Different package available per special request
- Note: All specifications subject to change without notice.