

- FILTER / TRANSIENT PROTECTION D-SUB CONNECTORS
- FILTER / TRANSIENT PROTECTION CIRCULAR MILITARY CONNECTORS
- FEED-THROUGH FILTERS

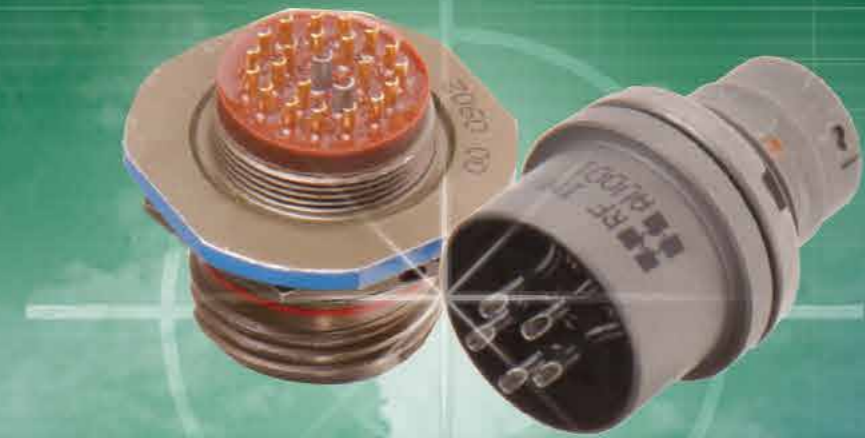

FILTER / TRANSIENT PROTECTION CIRCULAR MILITARY CONNECTORS

AN INNOVATIVE TECHNOLOGY OF FREQUENCY FILTERING

FILTER / TRANSIENT PROTECTION CIRCULAR MILITARY CONNECTORS



Company Profile

YOUR FIRST LINE OF DEFENSE

Established in 2002 as a privately owned company, RF Immunity specializes in design and manufacturing of **EMI/RFI Filtered connectors, Transient Protection, Hermetically Sealed and Customized connectors**. Our products are based on highly advanced filtering technologies and techniques. RF Immunity's miniaturized products are renowned for their quality and performance under extreme environmental conditions.

We've worked hard to achieve and maintain a world-class reputation for the highest level of excellence in quality, on time delivery and customer service that will always exceed the expectations of our customers, to the extent that we collaborate with customers at the earliest stages of design with comprehensive consulting, diagnostic testing and manufacturing services to develop optimum EMI/RFI filtered Connector solutions.

Our unique capabilities allow us to pass on to our customers reduced cycle times and time to market costs. This enables RF Immunity to be a true one stop source from prototype through production of EMC solutions for various applications in major electronics markets such as military, avionic, medical, commercial and more.

RF Immunity Ltd. Military Filtered and Transient Protection Connectors

A large diversity of connector sizes and types is available in various densities. All connectors meet the most stringent specifications of military standards: MIL-DTL-38999, MIL-DTL-26482, MIL-DTL-5015, MIL-DTL-83733, ARINC 404 and more.

Perfectly filtering Input/Output (I/O) interfaces of space-sensitive military systems demanding hermetic sealing, these filtered connectors are suitable for extreme environmental conditions. They can also include protective components to ensure transient resistance as well as fast HPM (High Power Microwave) pulse durability.

The entire assembly is integrated into a single package, where each contact has an individual filter with specific type and level.

Together with other complying design considerations, the use of these filtered connectors enables modern platforms to meet the following reference standards: MIL-STD-461, MIL-STD-1275, MIL-STD-704, RTCA-DO160.

Each filtering module is integrated into the connector, keeping the connector outer form and size unchanged and preserving system Form, Fit and Function (F³).

Designed for airborne, marine and ground-controlled portable equipment, this line of products can be used in a broad frequency range of up to 10 GHz.

The Advantages of the Innovative Filtering Technology Offered by RF Immunity Ltd.

➤ Easy retrofit and upgrade

Our compact connectors are the same in dimensions as the corresponding unfiltered connectors. System space is not to be concerned about allowing for easy retrofit and upgrade.

➤ Design flexibility

Our advanced design technologies enable the introduction of a complete selection of both electrical and mechanical solutions, while extensive knowledge allows us to offer design and production of filtered versions of most connector types.

➤ Reduced cost and lead times

With most standard contact arrangement designs, we can reduce the procurement costs and minimize the tooling expenses, down to zero. Moreover, we offer small quantities and prototypes.

➤ Weight and space saving

As the filtering elements are placed within the connectors, functional PCB area is kept minimal. Weight is saved compared to the standard configuration of a connector and separate discreet filtering components.

➤ Custom designs

We cater to various custom designs which call for specific filtering, transient protection, sealing, etc.



**FILTER / TRANSIENT PROTECTION
D-SUB CONNECTORS
MILITARY & COMMERCIAL**

AN INNOVATIVE TECHNOLOGY OF FREQUENCY FILTERING



Filtered Military Connectors

- Effective solutions for Avionics, Naval and Ground applications
- Filtering of types of metal connectors, Receptacles and Plugs
- Available with Filters, Transient Protection and Hermetically sealing
- Available with L.C., L.C., CL, P.T. Filters and double topologies
- Selective Working Voltage, Filter Type and Topology for each context
- Key of Power Control & Communications Lines
- Effective Frequency Range starts at 10MHz up to 30GHz



TVS and Lightning Protection Connectors

- Transient Voltage Suppressors integrated into the connector
- achieve most effective suppression
- Standard capability of up to 8 kA peak without enlarging the connector
- EFT (Electrical Fast Transients) & Lightning Protection integrated into the rear side of an enlarged connector
- TVS can be combined with ESD Bars or as a stand alone solution



Company Profile

RF Immunity established in 2002, is a privately owned company that specializes in the design and manufacturing of D9/D10 filtered connectors, transient protection connectors, hermetically sealed and customized connectors. Our products are based on highly advanced filtering technologies and techniques, and cater to the design and manufacturing of unique filtering solutions, made to meet the specific requirements of each customer. The specialized RF Immunity products are renowned for their quality and they perform perfectly under extreme environmental conditions.

The qualities of RF Immunity products make them an ideal choice for a variety of applications including military, commercial, aviation and marine. These products cover a wide range of frequency filtering filtered connectors and filtered units for single line as well as for multi-channel configurations, and protective devices for power supply systems.

We place much focus on designing customer specific solutions, presenting their devices from D9/D10 through and ensuring a reliable and effective solution. RF Immunity is a well established company, leading the market with proven capability and experience in the military, industrial and aviation spaces. The technical and highly advanced in-house technology makes choice an alternative of RF/EMF challenges. These challenges are successfully met by RF Immunity to the complete satisfaction of our customers' fulfilling all the necessary requirements.

Quality Assurance

RF Immunity quality program is ISO 9001 certified and is backed in accordance with the STQ (Ship to Stock) method quality program of prime customers. RF Immunity products are subject to intensive and highly-controlled test procedures carried out with top-quality tools, from complete acceptance preparation through precise control in final evaluation of the connector product.

Reference Standards

MIL-275-60, MIL-275-101, MIL-275-102, MIL-275-106, MIL-275-108, MIL-275-109, MIL-275-110, MIL-275-111

RF Immunity has distributors all around the world



For local distribution, visit our web site

3, Rue de France 93440, R122 | Tel : +33 23 2211200 | Fax : +33 23 2211210
E-mail : info@rfinnimmunity.com | www.rfinnimmunity.com



**An Innovative Technology
of Frequency Filtering**

www.rfinnimmunity.com



List of Contents

Circular Connector Families	Page	
MIL-DTL-38999 Series I, II, III	1	1-35
- Mechanics	3	
- Electrical	14	
MIL-DTL-26482 Series II	16	
- Mechanics	18	
- Electrical	23	
MIL-DTL-83723 Series III	25	
- Mechanics	27	
- Electrical	32	
Panel Cutout dimensions	34	
<hr/>		
Electrical Characteristics		36-68
Introductions & Content of Section	36	
General & Codes	37	
Attenuation Curves vs Filter Types	38	
Transient Protection	62	
Filters combined with Transient Protection	64	
<hr/>		
Other Filter Families		69-77
Audio / MIL-DTL-55116	70	
Arinc 600	72	
Arinc 404 / DPX / MIL-DTL- 81659	74	
DPK / MIL-DTL-83733	76	
Filter Array	77	
Feed Through Line Filters	77	
D-Sub Connectors	77	
<hr/>		
Selected Customized Products	78	78-83
AC Connectors	82	
Fast Communication Connectors	83	
<hr/>		
Design Notes	84	84-98
Check List	96	
Terms and Conditions	98	

Engineering and Filter Technology

RF Immunity is fully committed to developing and delivering best-of-breed filtered connectors. During its first decade, the company focused on developing unique advantages to create a strong market impact. We spent much time and effort in designing flexible solutions that are ideally suited to customer requirements. Our technology assures short delivery times, design flexibility and market advantages.

RF Immunity has a strong and highly skilled engineering department to support requests for custom made connectors. Our proven experience relies on long years of practice working hand in hand with global markets of military and industrial applications by developing unique electrical and mechanical products. Our engineering department is equipped with professional state of the art developing software. These tools and knowledge enable us to provide creative and high quality solutions in short developing periods.

RF Immunity's main filtering technology is comprised of discrete component array on PCB / SMT (Surface Mount Technology).

This technology enables great flexibility ensuring unlimited and cost effective filtering designs. Most of our filtering components are off-the-shelf products that allow us to offer fast delivery of prototypes and serial quantities.

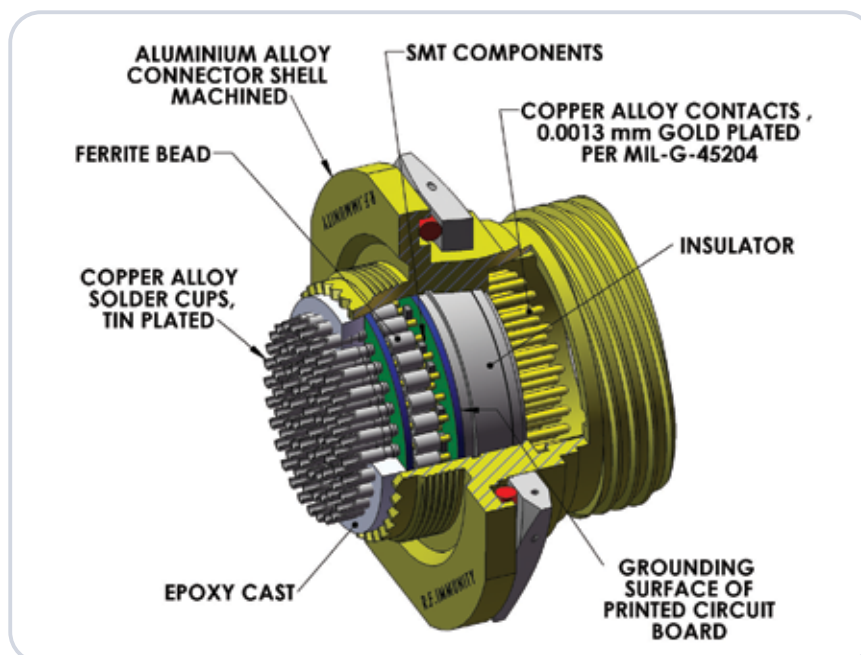

Testing

As part of our quality assurance managing procedure, each manufactured item at RF Immunity undergoes a number of in-depth electrical tests within the production process. These tests guarantee full compliance of the end product with the specification requirements, especially when addressing filter characteristics.

RF Immunity manufacturing plant has a laboratory, which is well-equipped to perform established and documented testing procedures. Each product is tested to confirm its compliance to the filter characteristics and the transient protection requirements as per the customer's specifications. Testing documentation is supplied to the end customer upon request.

We perform electrical characteristic inspections as follows:

- › Capacitance, Inductance, IR, Conductivity and Resistance
- › Common and Differential Mode Attenuation, Crosstalk in single ended and balanced lines (4-port network analyzer)
- › TVS and MOV Clamping
- › Burn-in

We perform mechanical and environmental inspections as follows:

- › Temperature Cycling and Thermal Shock
- › Humidity and Salt Spray
- › Hermetic sealing test
- › Durability
- › Vibration and Shock



Quality Assurance

"RF Immunity is aware that the products and solutions it produces are crucial to the correct function of the systems and equipment of our customers. Hence, we pay special attention to the quality and process inspection while constantly working towards the implementation of relevant improvements."

Regina Yoffe – Quality Manager.



The RF Immunity Quality Assurance.

We are committed to the full satisfaction of our customers and meeting all the technical requirements. Meeting the highest level of standard defined quality is our company mission, and an ongoing improvement program has been deployed at all levels of the enterprise.

RF Immunity quality program is ISO 9001 certified and is applied in accordance with the STS (Ship to Stock) method quality program of prime customers.

All our products are subject to meticulous and tightly-controlled test procedures carried out with top-quality tools; from component acceptance inspection, through process control to final examination of the completed products.

RF immunity can supply under customer request RoHS compliance filter connector. RF Immunity has been implementing since July the 1st, 2006, the European Directives restrictions regarding environmental responsibilities for electrical and electronics equipment manufacturers.



MIL-DTL-38999 connectors are available in a broad range of shell materials and finishes:

Stainless Steel Passivated, Marine Bronze and Aluminum shells with Electroless Nickel, Olive Drab Cadmium, Zinc-Nickel and Zinc-Cobalt plating.

The MIL-DTL-38999 family connectors are offered in a variety of shell styles - including Square Flange for Wall and Box mounting, Jam Nut receptacles and Plugs.

The Filtered Connectors are fully intermatable with standard (non-filtered) connectors and fit as a drop-in replacements for non-filtered connectors.

The mechanical and environmental features of shapes, sizes, insert arrangements and sealing levels are available as either standard or non-standard configuration of filter connector.

These connectors are offered with 2 up to 128 contacts - 22D, 20, 16, 12 and 8 size, in shell sizes of 9 to 25 (8 to 24 in series II).

RF Immunity offers a broad range of filtered MIL-DTL-38999 connectors with Signal, Power and Coaxial contacts.



MIL-DTL-38999 Series I

This series is a bayonet coupling configuration.

The square flange receptacles designed for front and rear Wall mounting and Box mounting. These connectors are inherently scoop-proof. Pins are recessed in elongated shells to prevent the possibility of bending contacts, when a mating shell is scooped into the shell.

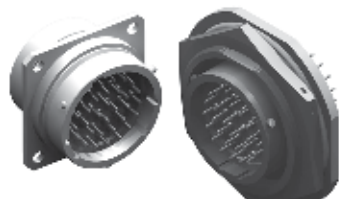

MIL-DTL-38999 Series II

This series is based on a bayonet coupling mechanism as Series I, but with significantly lower profile design and weight. Compared to Series I, the 128 contacts (size 24) mated pair is approximately 40% lighter. The reduction in both size and weight are achieved through use of thinner shell walls and length restrictions.

These design parameters slightly reduce the RFI attenuation characteristics compared to Series I and III.

The square flange receptacles designed for front and rear Wall mounting and Box mounting.



MIL-DTL-38999 Series III

This series provides an improved acme threaded coupling mechanism, that provides "one turn" coupling and disconnection.

With this coupling method these connectors provide withstanding in extreme environmental conditions of e.g. vibration, shock, fluid, sand and dust and both atmospheric and runway salts. In addition, Series III Plug connectors include a ratcheting self-locking device, which eliminates the need for safety wiring.

The MIL-DTL-38999 Series III connectors are the most common cylindrical connectors used in military applications these days.

Material & Finish

Part	Material & Finish	Part	Material & Finish
Connector Shell	Aluminium alloy, Olive drab Cadmium plated	Contacts	Copper alloy, Gold plated 1.27 µm
	Aluminium alloy, Electroless Nickel plated		(50 µInch) Min. over Electroless Nickel
	Aluminium alloy, Zinc-Cobalt plated		
	Aluminium alloy, Zinc-Nickel plated		
	Stainless Steel, passivated		
	Marine Bronze		
Insulator	High Grade Thermoplastic / Thermoset / Epoxy	Contacts Termination:	
Grommet & O-ring	Silicon based elastomer	PCB tail	Gold plated or Tin plated (pretinned)
		Solder Cup	Copper alloy, Tin plated

Content of Section

	Page
How To Order	2
Insert arrangements	3
Termination types	4
Environmental Conditions	4
MIL-DTL-38999 Series I Key Position	5
Shell types of MIL-DTL-38999 Series I	6-7
MIL-DTL-38999 Series II Key Position	8
Shell types of MIL-DTL-38999 Series II	9-10
MIL-DTL-38999 Series III Key Position	11
Shell types of MIL-DTL-38999 Series III	12-13
Electrical Characteristics	14-15

How To Order

C 1 W 23 F 35 P 1 N 10 PP28

MIL-DTL-38999 Series I, II, III

FAMILY

C- MIL-DTL-38999

SERIES

- 1- Series I
- 2- Series II
- 3- Series III

SHELL STYLE

- | | |
|---------------------------------------|---|
| J - Jam Nut receptacle | P - Plug |
| W - Wall Mount receptacle | A - Adaptor Receptacle to Plug |
| C - Wall Mount + Clinch Nut | R - Adaptor Receptacle to Receptacle |
| B - Box Mount receptacle | S - Special |
| X - Rear Wall Mount receptacle | |

SHELL SIZE

Series I & III - 09-11-13-15-17-19-21-23-25
 Series II - 08-10-12-14-16-18-20-22-24

MATERIAL & FINISH

- F**- Aluminum Alloy, Electroless Nickel Plating
- K** - Stainless Steel, Passivated, Corrosion resistant, without Firewall Capability
- W** - Aluminum Alloy, Olive drab Cadmium Plating
- ZC** - Aluminum Alloy, Zinc Cobalt Plating
- ZN** - Aluminium Alloy, Zinc Nickel Plating
- B** - Bronze
- S** - Other material and finish options

INSERT ARRANGEMENT

(See page 3)

CONTACT TYPE

Regular: **P**-Pin⁽¹⁾
 S-Socket⁽¹⁾
 Hermetically Sealed: **R**-Pin
 U-Socket] (See page 4 - table of Environmental conditions)

TERMINATION: See page 4

- | | | |
|--|---|---|
| 1 - Solder Cup | 4 - Short PCB Tail (Gold Plated) | 8 - Crimp |
| 2 - Short PCB Tail (Tin Plated) | 5 - Long PCB Tail (Gold Plated) | 9 - Special |
| 3 - Long PCB Tail (Tin Plated) | 7 - Solder Cup + Exposed teeth | 0 - No termination (for Adaptor) |

POLARIZATION

Key Position (See pages 5, 8, 11)

WORKING VOLTAGE: See page 37

- | | | | |
|----------------|----------------|-----------------|--|
| 01 6.3V | 07 200V | 14 800V | 00 - For filters with diversified voltages |
| 02 10V | 08 250V | 15 1000V | 99 - For any configuration that incorporates transient protection |
| 03 16V | 09 300V | 16 1500V | XX - Without filter |
| 04 25V | 10 400V | 17 2000V | |
| 05 50V | 11 500V | | |
| 06 100V | 12 600V | | |

FILTER CODE AND/OR TRANSIENT PROTECTION CODE: See page 37

xxxx - In case where a custom protection is required (diversity of filter types and/or transient protection types) fill XXXX.
 Contact sales for customizing.

(1) For Adaptor shell style indicates the Receptacle side gender. The Plug side gender is by default opposite.
 * Contact sales for filter connectors not included in this catalog.

Insert Arrangements Per MIL-STD-1560

Numbering example

Series I & III
Series II

(Odd sizes)
(Even sizes)

1198
1098

Shell Size

Insert Arrangement
6#20 (Contact quantity & Size)

MIL-DTL-38999
Series I, II, III



0935/0835
6 #22D



0998/0898
3 #20



1105/1005
5 #20



1135/1035
13 #22D



1198/1098
6 #20



1199/1099
7 #20



1304/1204
4 #16



1308/1208
8 #20



1335/1235
22 #22D



1398/1298
10 #20



1505/1405
5 #16



1515/1415
1 #16, 14 #20

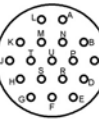

1518/1418
18 #20

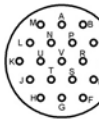

1519
19 #20



1535/1435
37 #22D

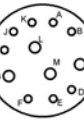

1597/1497
8 #20, 4 #16



1702
38 #22D, 1 #8
Twinax



1706/1606
6 #12

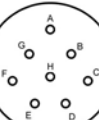

1708/1608
8 #16

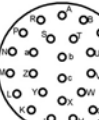

1726/1626
26 #20

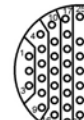

1735/1635
55 #22D



1799/1699
2 #16, 21 #20



1928/1828
26 #20, 2 #16



1932/1832
32 #20

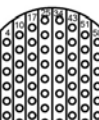

1935/1835
66 #22D

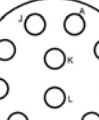

2111
11 #12



2141/2041
41 #20



2135/2035
79 #22D



2139/2039
37 #20, 2 #16



2116/2016
16 #16

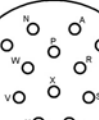

2321/2221
21 #16

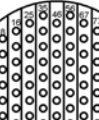

2335/2235
100 #22D



2353/2253
53 #20

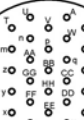

2355/2255
55 #20

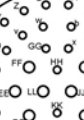

2504/2404
48 #20, 8 #16



2507
97 #22D, 2 #8
Twinax

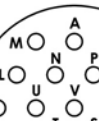

2519/2419
19 #12



2529/2429
29 #16

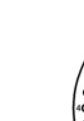

2535/2435
128 #22D



2546
40 #20, 4 #16, 2 #8
Coax



2561/2461
61 #20

* Front face of Pin insert is shown. Socket insert is opposite.
* For other insert arrangements contact sales.

Termination Types

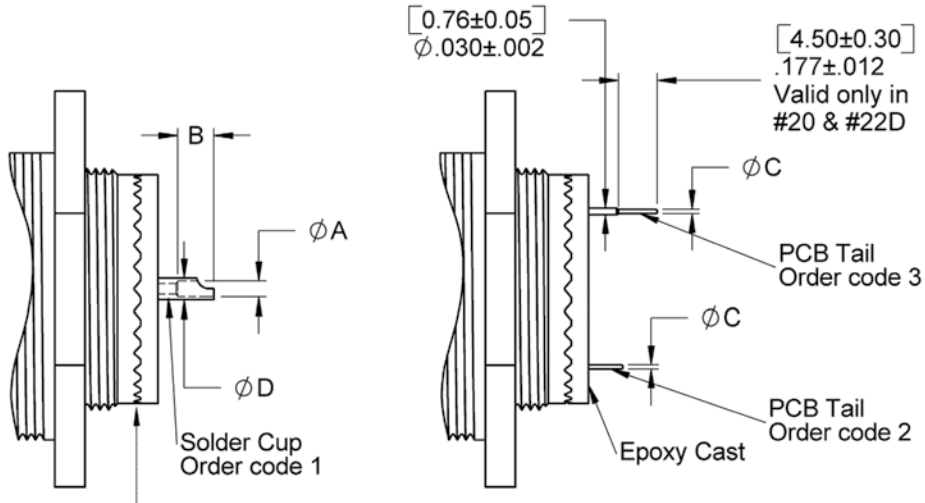

Accessory teeth are by default epoxy cast covered and cannot be used for wiring accessories. For exposed teeth choose "7" Termination designator at P/N.

* For D38999 series II – the marked dimension is .283 [7.2]

Termination Dimensions

For Termination length refer to specific shell dimensions table – pages 6, 7, 9, 10, 12, 13 – columns H, T, V.

Contact Size	#22	#20	#16	#12
Ø A ± .002	.043	.043	.074	.114
[±0.05]	[1.10]	[1.10]	[1.90]	[2.90]
B ± .012	.126	.126	.149	4.20
[±0.30]	[3.20]	[3.20]	[3.80]	[.165]
Ø C ± .002	.002	.002	.046	2.06
[±0.05]	[0.5]	[0.5]	[1.16]	[.081]
Ø D ± .002	.059	.059	.100	3.60
[±0.05]	[1.50]	[1.50]	[2.54]	[.141]

Environmental Conditions

Description	Values	PARAGRAPH PER			
		ISO 2100	ISO 7137	MIL-STD-1344	MIL-STD- 202
Sealing**	Air Leakage 5×10^{-3} cm ³ / sec at Δ P = 1atm on mated connector				
Vibration (Random)	Up to 40g RMS 20-2000Hz	12		2005.1	201,204,214
Vibration (Sine)	Up to 15g PTP 10-2000Hz	12		2005.1	201,204,214
Shock	100g X 6msec Half Sine		7	2004.1	213
Acceleration	40g	19			
Climatic					103,106
Temperature	-55°C to +125°C Operating & Storage				
Humidity	Up to 95% @ Storage Temperature range	18b		1002.2	
Altitude	Up to 70,000 ft	18a	4		
Salt Spray	500 hours for Aluminium Olive Drab Cadmium or Zinc-Nickel plated or Stainless Steel, 48 hours for Aluminium Electroless Nickel or Zinc-Cobalt plated, 1000 hours for Bronze	22		1001.1	101
Sand & Dust		23	12		110
Contact Endurance	More than 500 mating cycles	16			

** For Hermetically sealed connector the leakage is 10^{-5} cm³/sec Helium at Δ P = 1atm

* Dimensions are in Inches. Values in brackets are Millimeters equivalents.

* Dimensions subject to change without prior notice.

Key Position

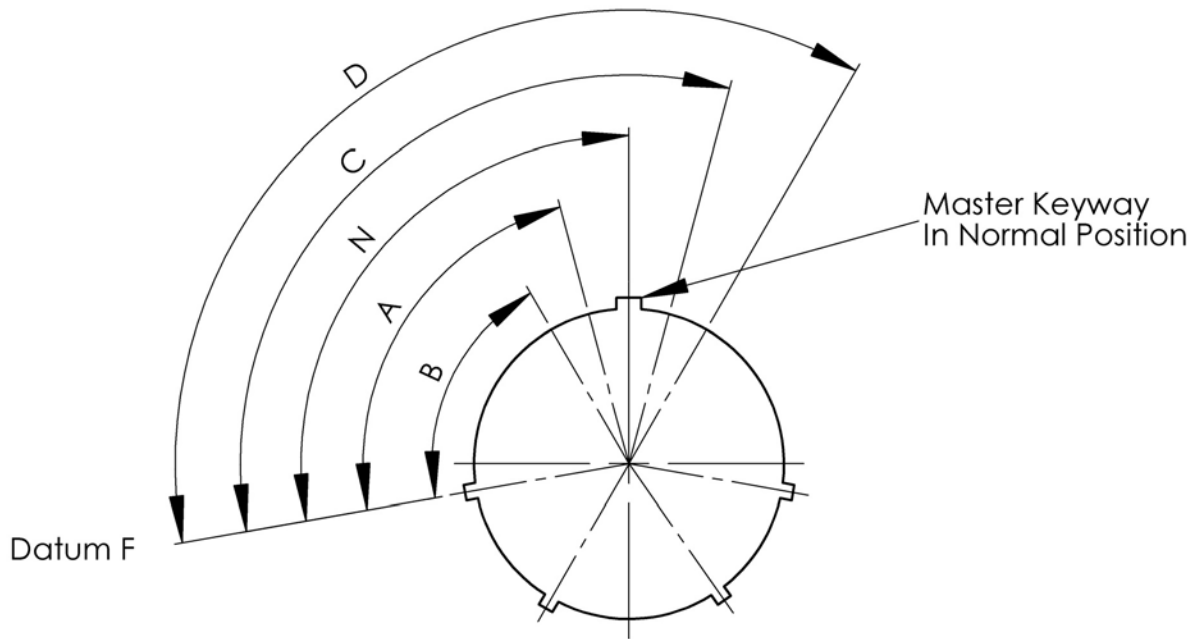

Mating face of Receptacle is shown in the figure (Plug is opposite).

Shell Size	Keying Positions				
	N	A	B	C	D
9	95	77	-	-	113
11	95	81	67	123	109
13	95	75	63	127	115
15	95	74	61	129	116
17	95	77	65	125	113
19	95	77	65	125	113
21	95	77	65	125	113
23	95	80	69	121	110
25	95	80	69	121	110

The master keyway is rotated to provide shell polarization the minor keys remain fixed. Insert Arrangement does not rotate with the Keyway.

C1W Wall Mount Receptacle (MS27466 Compatible)

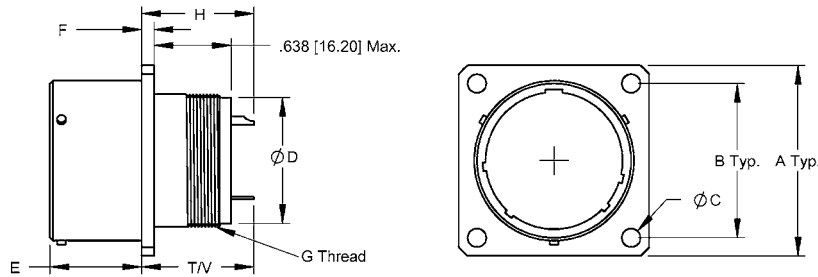

Shell Size	A Max	B ±.004 [±0.1]	Ø C +.010 [0.25] -.005 [0.13]	Ø D Max	E Max	F Max	G Thread	H Max		T ± .028 [±0.7]	V ± .028 [±0.7]
								#22, #20, #16	#12		
9	.958 [24.3]	.719 [18.3]	.128 [3.25]	.4375 [11.1]	.632 [16.05]	.100 [2.54]	.4375-28 UNEF	.874 [22.2]	.953 [24.2]	1.052 [26.7]	.953 [24.2]
11	1.051 [26.7]	.812 [20.6]	.128 [3.25]	.5625 [14.3]	.632 [16.05]	.100 [2.54]	.5625-24 UNEF	.874 [22.2]	.953 [24.2]	1.052 [26.7]	.953 [24.2]
13	1.145 [29.1]	.906 [23.0]	.128 [3.25]	.6875 [17.5]	.632 [16.05]	.100 [2.54]	.6875-24 UNEF	.874 [22.2]	.953 [24.2]	1.052 [26.7]	.953 [24.2]
15	1.239 [31.5]	.969 [24.6]	.128 [3.25]	.8125 [20.6]	.632 [16.05]	.100 [2.54]	.8125-20 UNEF	.874 [22.2]	.953 [24.2]	1.052 [26.7]	.953 [24.2]
17	1.332 [33.8]	1.062 [27.0]	.128 [3.25]	.9375 [23.8]	.632 [16.05]	.100 [2.54]	.9375-20 UNEF	.874 [22.2]	.953 [24.2]	1.052 [26.7]	.953 [24.2]
19	1.458 [37.0]	1.156 [29.4]	.128 [3.25]	1.0625 [27.0]	.632 [16.05]	.100 [2.54]	1.0625- 18 UNEF	.874 [22.2]	.953 [24.2]	1.052 [26.7]	.953 [24.2]
21	1.582 [40.2]	1.250 [31.8]	.128 [3.25]	1.875 [30.2]	.602 [15.3]	.130 [3.3]	1.1875- 18 UNEF	.906 [23.0]	.984 [25.0]	1.082 [27.5]	.983 [25.0]
23	1.708 [43.4]	1.375 [34.9]	.147 [3.7]	1.313 [33.3]	.602 [15.3]	.130 [3.3]	1.3125- 18 UNEF	.906 [23.0]	.984 [25.0]	1.082 [27.5]	.983 [25.0]
25	1.832 [46.5]	1.500 [38.1]	.147 [3.7]	1.438 [36.5]	.602 [15.3]	.130 [3.3]	1.4375- 18 UNEF	.906 [23.0]	.984 [25.0]	1.082 [27.5]	.983 [25.0]

C1J Jam Nut Receptacle (MS27468 Compatible)

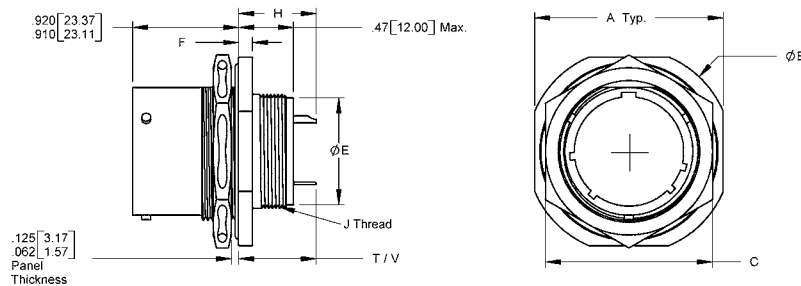

Shell Size	A Max	Ø B Max	C Max	Ø E Max	J Thread	F ± .010 [±0.25]	H Max		T ± .028 [±0.7]	V ± .028 [±0.7]
							#22, #20, #16	#12		
9	1.078 [27.4]	1.204 [30.6]	.892 [22.7]	.4375 [11.1]	.4375-28 UNEF	.109 [2.8]	.591 [15.0]	.669 [17.0]	.768 [19.5]	.669 [17.0]
11	1.266 [32.2]	1.391 [35.3]	1.017 [25.8]	.5625 [14.3]	.5625-24 UNEF	.109 [2.8]	.591 [15.0]	.669 [17.0]	.768 [19.5]	.669 [17.0]
13	1.391 [35.3]	1.516 [38.5]	1.205 [30.6]	.6875 [17.5]	.6875-24 UNEF	.109 [2.8]	.591 [15.0]	.669 [17.0]	.768 [19.5]	.669 [17.0]
15	1.516 [38.5]	1.641 [41.7]	1.329 [33.8]	.8125 [20.6]	.8125-20 UNEF	.109 [2.8]	.591 [15.0]	.669 [17.0]	.768 [19.5]	.669 [17.0]
17	1.641 [41.7]	1.766 [44.9]	1.455 [37.0]	.9375 [23.8]	.9375-20 UNEF	.109 [2.8]	.591 [15.0]	.669 [17.0]	.768 [19.5]	.669 [17.0]
19	1.828 [46.4]	1.954 [49.6]	1.579 [40.1]	1.0625 [27.0]	1.0625-18 UNEF	.140 [3.6]	.591 [15.0]	.669 [17.0]	.768 [19.5]	.669 [17.0]
21	1.954 [49.6]	2.078 [52.8]	1.705 [43.3]	1.875 [30.2]	1.1875-18 UNEF	.140 [3.6]	.621 [15.8]	.700 [17.8]	.798 [20.3]	.699 [17.8]
23	2.078 [52.8]	2.204 [56.0]	1.829 [46.5]	1.3125 [33.3]	1.3125-18 UNEF	.140 [3.6]	.621 [15.8]	.700 [17.8]	.798 [20.3]	.699 [17.8]
25	2.204 [56.0]	2.328 [59.1]	2.017 [51.2]	1.4375 [36.5]	1.4375-18 UNEF	.140 [3.6]	.621 [15.8]	.700 [17.8]	.798 [20.3]	.699 [17.8]

* For panel cutout dimensions refer to pages 34-35.
 * Dimensions are in Inches. Values in brackets are Millimeters equivalents.
 * Dimensions subject to change without prior notice.

C1X Rear Wall Mount Receptacle (MS27656 Compatible)

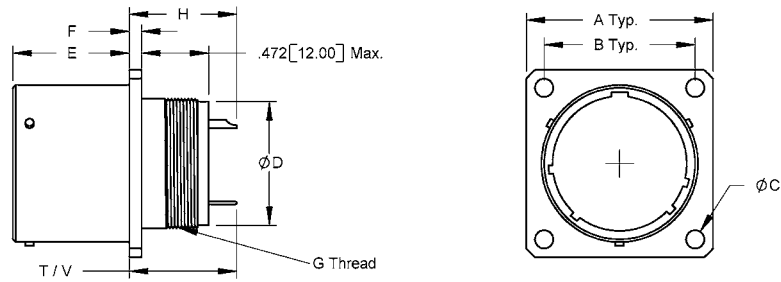

Shell Size	A Max	B ± .008 [±0.2]	Ø C ± .005 [±0.13]	Ø D Max	E Max	F +.015 [+0.4]	G Thread	H Max		T ± .028 [±0.7]	V ± .028 [±0.7]
								#22, #20, #16	#12		
9	.958	.719	.128	.4375	.820	.085	.4375-28	.689	.768	.864	.766
	[24.3]	[18.3]	[3.25]	[11.1]	[20.8]	[2.2]	UNEF	[17.50]	[19.50]	[21.9]	[19.5]
11	1.051	.812	.128	.5625	.820	.085	.5625-24	.689	.768	.864	.766
	[26.7]	[20.6]	[3.25]	[14.3]	[20.8]	[2.2]	UNEF	[17.50]	[19.50]	[21.9]	[19.5]
13	1.145	.906	.128	.6875	.820	.085	.6875-24	.689	.768	.864	.766
	[29.1]	[23.0]	[3.25]	[17.5]	[20.8]	[2.2]	UNEF	[17.50]	[19.50]	[21.9]	[19.5]
15	1.239	.969	.128	.8125	.820	.085	.8125-20	.689	.768	.864	.766
	[31.5]	[24.6]	[3.25]	[20.6]	[20.8]	[2.2]	UNEF	[17.50]	[19.50]	[21.9]	[19.5]
17	1.332	1.062	.128	.9375	.820	.085	.9375-20	.689	.768	.864	.766
	[33.8]	[27.0]	[3.25]	[23.8]	[20.8]	[2.2]	UNEF	[17.50]	[19.50]	[21.9]	[19.5]
19	1.458	1.156	.128	1.0625	.820	.085	1.0625-18	.689	.768	.864	.766
	[37.0]	[29.4]	[3.25]	[27.0]	[20.8]	[2.2]	UNEF	[17.50]	[19.50]	[21.9]	[19.5]
21	1.582	1.250	.128	1.875	.790	.115	1.1875-18	.717	.796	.894	.796
	[40.2]	[31.8]	[3.25]	[30.2]	[20.1]	[2.9]	UNEF	[18.20]	[20.20]	[22.7]	[20.2]
23	1.708	1.375	.147	1.3125	.790	.115	1.3125-18	.717	.796	.894	.796
	[43.4]	[34.9]	[3.7]	[33.3]	[20.1]	[2.9]	UNEF	[18.20]	[20.20]	[22.7]	[20.2]
25	1.832	1.500	.147	1.4375	.790	.115	1.4375-18	.717	.796	.894	.796
	[46.5]	[38.1]	[3.7]	[36.5]	[20.1]	[2.9]	UNEF	[18.20]	[20.20]	[22.7]	[20.2]

C1P Plug Shell (MS27467 Compatible)

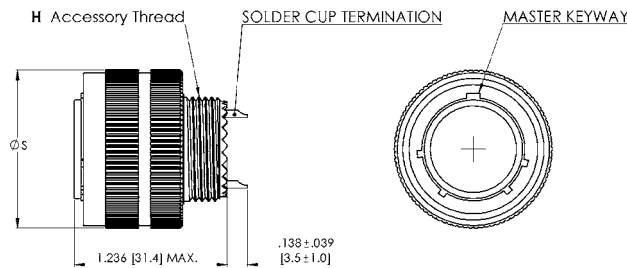

Shell Size	H Thread	S Max.
09	.4375-28	.859
	UNEF	[21.8]
11	.5625-24	.984
	UNEF	[25.0]
13	.6875-24	1.156
	UNEF	[29.4]
15	.8125-20	1.281
	UNEF	[32.5]
17	.9375-20	1.406
	UNEF	[35.7]
19	1.0625-18	1.516
	UNEF	[38.5]
21	1.1875-18	1.641
	UNEF	[41.7]
23	1.3125-18	1.766
	UNEF	[44.9]
25	1.4375-18	1.891
	UNEF	[48.0]

* For panel cutout dimensions refer to pages 34-35.
 * Dimensions are in Inches. Values in brackets are Millimeters equivalents.
 * Dimensions subject to change without prior notice.

Key Position

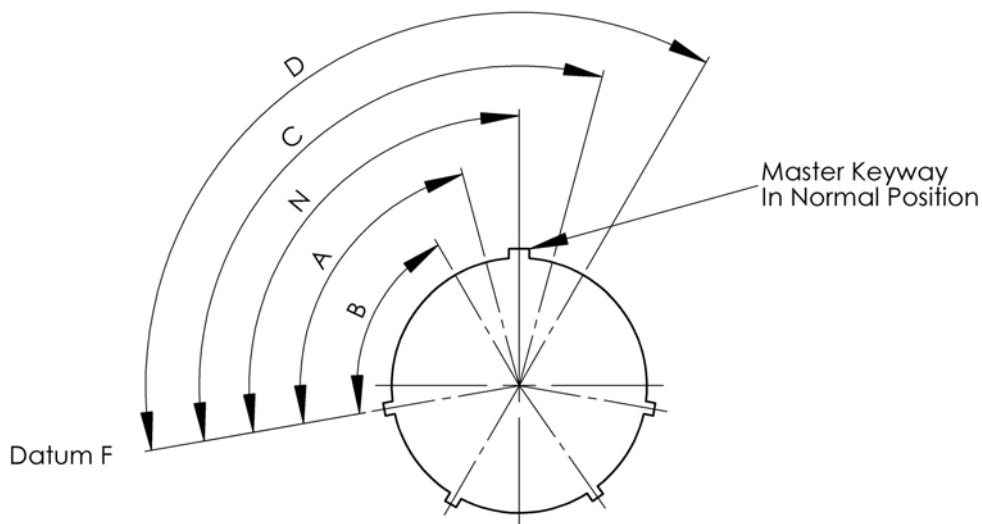

Mating face of receptacle is shown in the figure (Plug is opposite).

Shell Size	Keying Positions				
	N	A	B	C	D
8	100	82	-	-	118
10	100	86	72	128	114
12	100	80	68	132	120
14	100	79	66	134	121
16	100	82	70	130	118
18	100	82	70	130	118
20	100	82	70	130	118
22	100	85	74	126	115
24	100	85	74	126	115

The master keyway is rotated to provide shell polarization the minor keys remain fixed.
Insert Arrangement does not rotate with the Keyway.

* Dimensions are in Inches. Values in brackets are Millimeters equivalents.

* Dimensions subject to change without prior notice.

C2J Jam Nut Receptacle (MS27474 Compatible)

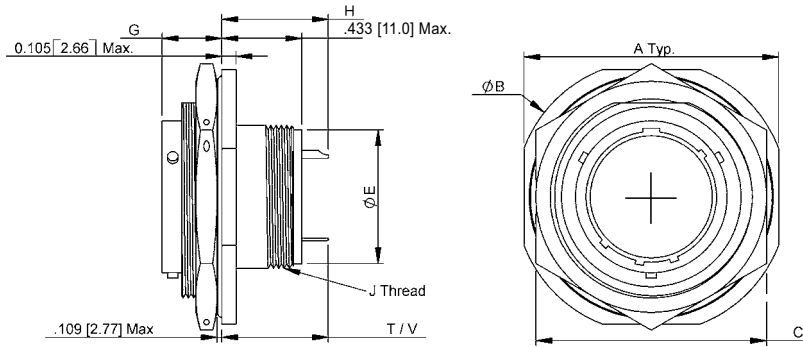

Shell Size	A Max	Ø B Max	C Max	Ø E Max	G Max	J Thread	H Max		T ± .028 [±0.7]	V ± .028 [±0.7]
							#22, #20, #16	#12		
8	1.266 [32.2]	1.391 [35.3]	1.079 [27.4]	.4375 [11.1]	.443 [11.25]	.4375-28 UNEF	.591 [15.0]	.669 [17.0]	.780 [19.8]	.630 [16.0]
10	1.389 [35.3]	1.515 [38.5]	1.206 [30.6]	.5625 [14.3]	.443 [11.25]	.5625-24 UNEF	.591 [15.0]	.669 [17.0]	.780 [19.8]	.630 [16.0]
12	1.515 [38.5]	1.641 [41.7]	1.329 [33.8]	.6875 [17.5]	.443 [11.25]	.6875-24 UNEF	.591 [15.0]	.669 [17.0]	.780 [19.8]	.630 [16.0]
14	1.641 [41.7]	1.766 [44.9]	1.455 [37.0]	.8125 [20.6]	.443 [11.25]	.8125-20 UNEF	.591 [15.0]	.669 [17.0]	.780 [19.8]	.630 [16.0]
16	1.795 [45.6]	1.954 [49.6]	1.579 [40.1]	.9375 [23.8]	.443 [11.25]	.9375-20 UNEF	.591 [15.0]	.669 [17.0]	.780 [19.8]	.630 [16.0]
18	1.905 [48.4]	2.031 [51.6]	1.705 [43.3]	1.0625 [27.0]	.443 [11.25]	1.0625-18 UNEF	.591 [15.0]	.669 [17.0]	.780 [19.8]	.630 [16.0]
20	2.031 [51.6]	2.157 [54.8]	1.829 [46.5]	1.1875 [30.2]	.469 [11.9]	1.1875-18 UNEF	.591 [15.0]	.669 [17.0]	.752 [19.1]	.602 [15.3]
22	2.156 [54.7]	2.281 [57.9]	2.017 [51.2]	1.3125 [33.3]	.469 [11.9]	1.3125-18 UNEF	.591 [15.0]	.669 [17.0]	.752 [19.1]	.602 [15.3]
24	2.279 [57.9]	2.405 [61.1]	2.142 [54.4]	1.4375 [36.5]	.469 [11.9]	1.4375-18 UNEF	.591 [15.0]	.669 [17.0]	.752 [19.1]	.602 [15.3]

C2B Box Mount Receptacle (MS27499 Compatible)

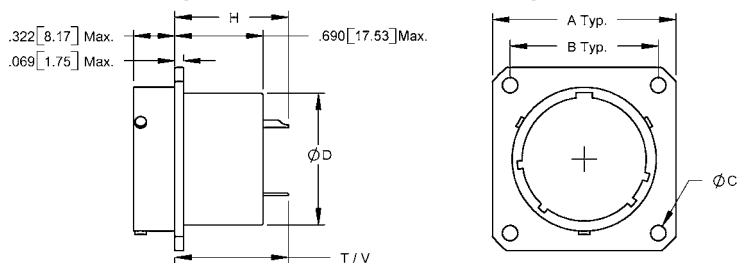

Shell Size	A Max	B ±0.008 [± 0.2]	Ø C ±.008 [± 0.2]	Ø D ±.008 [± 0.2]	H Max		T ± .028 [±0.7]	V ± .028 [±0.7]
					#22, #20, #16	#12		
8	.827 [21.0]	.594 [15.1]	.120 [3.05]	.453 [11.1]	.827 [21.0]	.906 [23.0]	1.025 [26.0]	1.123 [28.5]
10	.953 [24.2]	.719 [18.3]	.120 [3.05]	.578 [14.7]	.827 [21.0]	.906 [23.0]	1.025 [26.0]	1.123 [28.5]
12	1.047 [26.6]	.812 [20.6]	.120 [3.05]	.703 [17.9]	.827 [21.0]	.906 [23.0]	1.025 [26.0]	1.123 [28.5]
14	1.141 [29.0]	.906 [23.0]	.120 [3.05]	.828 [21.0]	.827 [21.0]	.906 [23.0]	1.025 [26.0]	1.123 [28.5]
16	1.234 [31.3]	.969 [24.6]	.120 [3.05]	.953 [24.2]	.827 [21.0]	.906 [23.0]	1.025 [26.0]	1.123 [28.5]
18	1.327 [33.7]	1.062 [27.0]	.120 [3.05]	1.062 [27.0]	.827 [21.0]	.906 [23.0]	1.025 [26.0]	1.123 [28.5]
20	1.453 [36.9]	1.156 [29.4]	.120 [3.05]	1.188 [30.2]	.827 [21.0]	.906 [23.0]	1.025 [26.0]	1.123 [28.5]
22	1.578 [40.1]	1.250 [31.8]	.120 [3.05]	1.312 [33.3]	.827 [21.0]	.906 [23.0]	1.025 [26.0]	1.123 [28.5]
24	1.703 [43.3]	1.375 [34.9]	.147 [3.7]	1.438 [36.5]	.827 [21.0]	.906 [23.0]	1.025 [26.0]	1.123 [28.5]

* For panel cutout dimensions refer to pages 34-35.
 * Dimensions are in Inches. Values in brackets are Millimeters equivalents.
 * Dimensions subject to change without prior notice.

C2X Rear Wall Mount Receptacle (MS27497 Compatible)

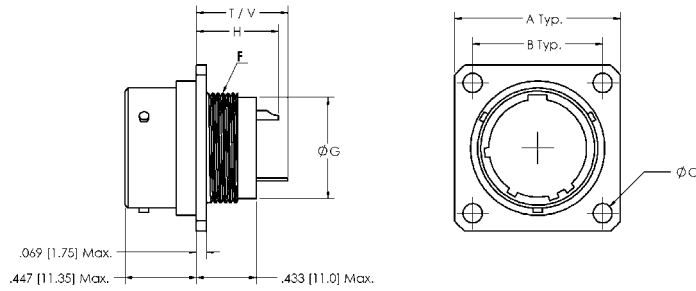

Shell Size	A Max	B ±0.004 [± 0.1]	Ø C ±.005 [± 0.13]	F Thread	Ø G Max.	H Max		T ± .028 [±0.7]	V ± .028 [±0.7]
						#22, #20, #16	#12		
8	.827 [21.0]	.594 [15.1]	.120 [3.05]	.4375-28 UNEF	.4375 [11.1]	.591 [15.0]	.669 [17.0]	.780 [19.8]	.630 [16.0]
10	.953 [24.2]	.719 [18.3]	.120 [3.05]	.5625-24 UNEF	.5625 [14.3]	.591 [15.0]	.669 [17.0]	.780 [19.8]	.630 [16.0]
12	1.047 [26.6]	.812 [20.6]	.120 [3.05]	.6875-24 UNEF	.6875 [17.5]	.591 [15.0]	.669 [17.0]	.780 [19.8]	.630 [16.0]
14	1.141 [29.0]	.906 [23.0]	.120 [3.05]	.8125-20 UNEF	.8125 [20.6]	.591 [15.0]	.669 [17.0]	.780 [19.8]	.630 [16.0]
16	1.234 [31.3]	.969 [24.6]	.120 [3.05]	.9375-20 UNEF	.9375 [23.8]	.591 [15.0]	.669 [17.0]	.780 [19.8]	.630 [16.0]
18	1.327 [33.7]	1.062 [27.0]	.120 [3.05]	1.0625-18 UNEF	1.0625 [27.0]	.591 [15.0]	.669 [17.0]	.780 [19.8]	.630 [16.0]
20	1.453 [36.9]	1.156 [29.4]	.120 [3.05]	1.1875-18 UNEF	1.1875 [30.2]	.591 [15.0]	.669 [17.0]	.752 [19.1]	.602 [15.3]
22	1.578 [40.1]	1.250 [31.8]	.120 [3.05]	1.3125-18 UNEF	1.3125 [33.3]	.591 [15.0]	.669 [17.0]	.752 [19.1]	.602 [15.3]
24	1.703 [43.3]	1.375 [34.9]	.147 [3.7]	1.4375-18 UNEF	1.4375 [36.5]	.591 [15.0]	.669 [17.0]	.752 [19.1]	.602 [15.3]

C2P Plug Shell (MS27484 Compatible)

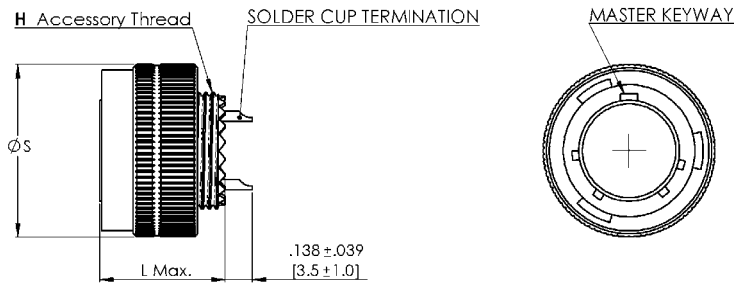

Shell Size	L Max.	H Thread	S Max.
8	.826 [21.0]	.4375-28 UNEF	.750 [19.1]
10	.826 [21.0]	.5625-24 UNEF	.859 [21.8]
12	.826 [21.0]	.6875-24 UNEF	1.031 [26.2]
14	.826 [21.0]	.8125-20 UNEF	1.156 [29.4]
16	.826 [21.0]	.9375-20 UNEF	1.281 [32.6]
18	.826 [21.0]	1.0625-18 UNEF	1.406 [35.7]
20	.826 [21.0]	1.1875-18 UNEF	1.531 [38.9]
22	.826 [21.0]	1.3125-18 UNEF	1.641 [41.7]
24	.894 [22.7]	1.4375-18 UNEF	1.766 [44.9]

* For panel cutout dimensions refer to pages 34-35.
 * Dimensions are in Inches. Values in brackets are Millimeters equivalents.
 * Dimensions subject to change without prior notice.

Key Position

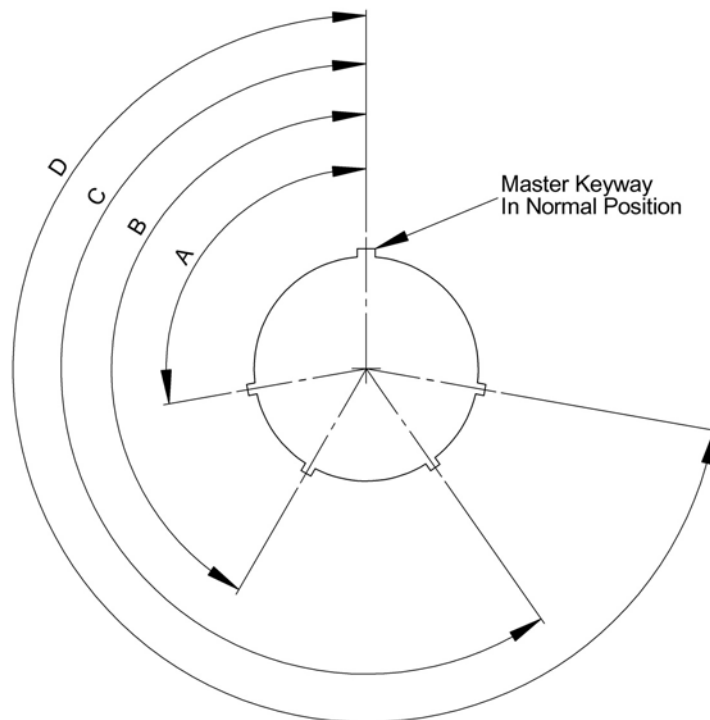

Mating face of receptacle is shown in the figure (Plug is opposite).

Size	Polarizing Positions	Key Locations			
		A	B	C	D
9	N	105	140	215	265
	A	102	132	248	320
	B	80	118	230	312
	C	35	140	205	275
	D	64	155	234	304
11 to 15	E	91	131	197	240
	N	95	141	208	236
	A	113	156	182	292
	B	90	145	195	252
	C	53	156	220	255
17 to 25	D	119	146	176	298
	E	51	141	184	242
	N	80	142	195	293
	A	135	170	200	310
	B	49	169	200	244
17 to 25	C	66	140	200	257
	D	62	145	180	280
	E	79	153	190	272

The master keyway is fixed, all minor keys are rotated to provide shell polarization. Insert Arrangement does not rotate with the Keyway.

* Dimensions are in Inches. Values in brackets are Millimeters equivalents.

* Dimensions subject to change without prior notice.

C3W Wall Mount Receptacle (D38999/20 Compatible)

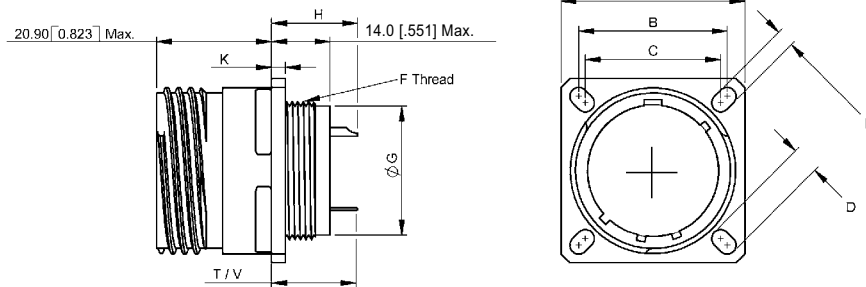

Shell Size	A ±0.3 [±.012]	B ±0.26 [±.010]	C ±0.26 [±.010]	D ±0.2 [±.008]	E ±0.2 [±.008]	F Thread	Ø G Max	H Max		K	T ±.028 [±0.7]	V ±.028 [±0.7]
								#22, #20, #16	#12			
9	23.8 [.937]	18.26 [.719]	15.09 [.594]	5.5 [.216]	3.25 [.128]	M12x1.0-6g 0.100R	12.0 [.472]	18.5 [.728]	20.5 [.807]	2.1/2.5 [.083/.098]	23.0 [.905]	20.5 [.807]
11	26.2 [1.031]	20.62 [.812]	18.26 [.719]	4.9 [.194]	3.25 [.128]	M15x1.0-6g 0.100R	15.0 [.590]	18.5 [.728]	20.5 [.807]	2.1/2.5 [.083/.098]	23.0 [.905]	20.5 [.807]
13	28.6 [1.126]	23.01 [.906]	20.62 [.812]	4.9 [.194]	3.25 [.128]	M18x1.0-6g 0.100R	18.0 [.708]	18.5 [.728]	20.5 [.807]	2.1/2.5 [.083/.098]	23.0 [.905]	20.5 [.807]
15	31.0 [1.220]	24.61 [.969]	23.01 [.906]	4.4 [.172]	3.25 [.128]	M22x1.0-6g 0.100R	22.0 [.866]	18.5 [.728]	20.5 [.807]	2.1/2.5 [.083/.098]	23.0 [.905]	20.5 [.807]
17	33.3 [1.311]	26.97 [1.062]	24.61 [.969]	4.9 [.194]	3.25 [.128]	M25x1.0-6g 0.100R	25.0 [.984]	18.5 [.728]	20.5 [.807]	2.1/2.5 [.083/.098]	23.0 [.905]	20.5 [.807]
19	36.5 [1.437]	29.36 [1.156]	26.97 [1.062]	4.9 [.194]	3.25 [.128]	M28x1.0-6g 0.100R	28.0 [1.102]	18.5 [.728]	20.5 [.807]	2.1/2.5 [.083/.098]	23.0 [.905]	20.5 [.807]
21	39.7 [1.563]	31.75 [1.250]	29.36 [1.156]	4.9 [.194]	3.25 [.128]	M31x1.0-6g 0.100R	31.0 [1.220]	18.5 [.728]	20.5 [.807]	2.1/3.2 [.083/.126]	23.0 [.905]	20.5 [.807]
23	42.9 [1.689]	34.93 [1.375]	31.75 [1.250]	6.2 [.242]	3.9 [.154]	M34x1.0-6g 0.100R	34.0 [1.338]	18.5 [.728]	20.5 [.807]	2.1/3.2 [.083/.126]	23.0 [.905]	20.5 [.807]
25	46.0 [1.811]	38.10 [1.500]	34.93 [1.375]	6.2 [.242]	3.9 [.154]	M37x1.0-6g 0.100R	37.0 [1.457]	18.5 [.728]	20.5 [.807]	2.1/3.2 [.083/.126]	23.0 [.905]	20.5 [.807]

C3J Jam Nut Receptacle (D38999/24 Compatible)

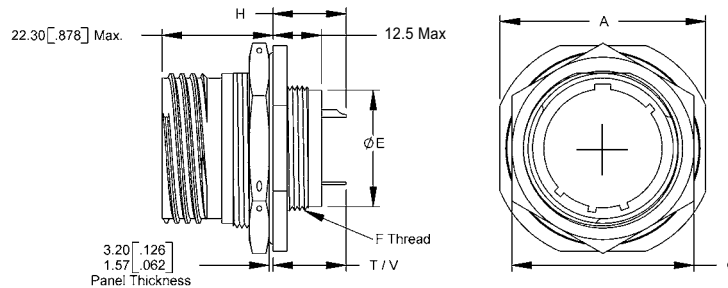

Shell Size	A ±0.4 [±.016]	C Max	Ø E Max	F Thread	H Max		T ±.028 [±0.7]	V ±.028 [±0.7]
					#22, #20, #16	#12		
9	27.0 [1.063]	24.0 [.945]	12.0 [.472]	M12x1.0-6g 0.100R	16.0 [.630]	18.0 [.709]	20.3 [.799]	17.8 [.700]
11	31.8 [1.252]	27.0 [1.063]	15.0 [.590]	M15x1.0-6g 0.100R	16.0 [.630]	18.0 [.709]	20.3 [.799]	17.8 [.700]
13	34.9 [1.374]	32.0 [1.260]	18.0 [.708]	M18x1.0-6g 0.100R	16.0 [.630]	18.0 [.709]	20.3 [.799]	17.8 [.700]
15	38.1 [1.500]	36.0 [1.417]	22.0 [.866]	M22x1.0-6g 0.100R	16.0 [.630]	18.0 [.709]	20.3 [.799]	17.8 [.700]
17	41.3 [1.626]	37.0 [1.457]	25.0 [.984]	M25x1.0-6g 0.100R	16.0 [.630]	18.0 [.709]	20.3 [.799]	17.8 [.700]
19	46.0 [1.811]	41.0 [1.614]	28.0 [1.102]	M28x1.0-6g 0.100R	16.0 [.630]	18.0 [.709]	20.3 [.799]	17.8 [.700]
21	49.2 [1.937]	46.0 [1.811]	31.0 [1.220]	M31x1.0-6g 0.100R	16.0 [.630]	18.0 [.709]	21.1 [.829]	17.8 [.700]
23	52.4 [2.063]	50.0 [1.969]	34.0 [1.338]	M34x1.0-6g 0.100R	16.0 [.630]	18.0 [.709]	21.1 [.829]	17.8 [.700]
25	55.6 [2.189]	51.2 [2.017]	37.0 [1.457]	M37x1.0-6g 0.100R	16.0 [.630]	18.0 [.709]	21.1 [.829]	17.8 [.700]

* For panel cutout dimensions refer to pages 34-35.
 * Dimensions are in Inches. Values in brackets are Millimeters equivalents.
 * Dimensions subject to change without prior notice.

C3P Plug Shell (D38999/26 Compatible)

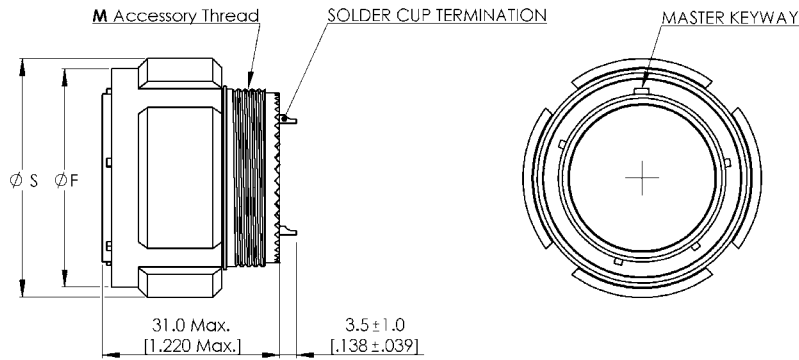

Shell Size	F +0.2/-0	M Thread	S Max.
09	18.5 [0.728]	M12x1.0-6g	21.2 [0.835]
11	21.2 [0.834]	M15x1.0-6g	23.7 [0.931]
13	25.5 [1.003]	M18x1.0-6g	29.0 [1.143]
15	28.8 [1.133]	M22x1.0-6g	32.3 [1.270]
17	32.3 [1.271]	M25x1.0-6g	35.5 [1.398]
19	35.0 [1.377]	M28x1.0-6g	37.9 [1.493]
21	38.2 [1.503]	M31x1.0-6g	41.7 [1.640]
23	41.2 [1.622]	M34x1.0-6g	44.1 [1.737]
25	44.4 [1.748]	M37x1.0-6g	47.4 [1.864]

MIL-DTL-38999
Series III

C3A Adaptor Receptacle to Plug - Pin to Socket

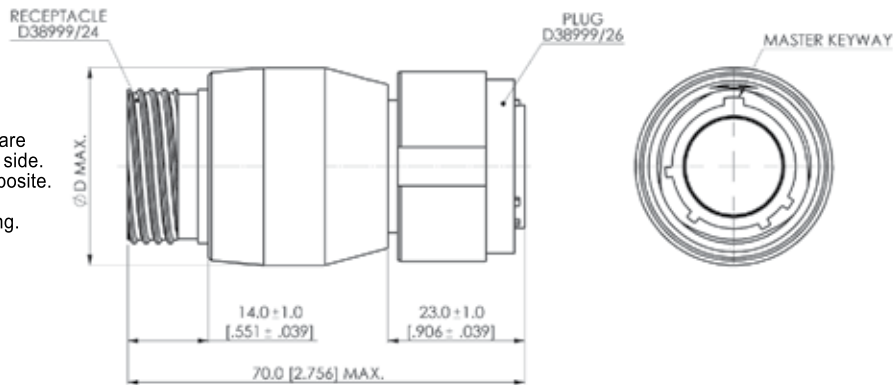

* The Pin or Socket contacts are available on each Adaptor's side. The other side gender is opposite.
Contact sales for customizing.

Shell Size	9	11	13	15	17	19	21	23	25
Ø D Max.	23.0 [.906]	27.0 [1.063]	31.0 [1.220]	34.0 [1.339]	39.0 [1.535]	42.0 [1.654]	44.0 [1.732]	47.0 [1.850]	50.0 [1.969]

* Dimensions are in Millimeters. Values in brackets are Inches equivalents.
* Dimensions subject to change without prior notice.

Filter Electrical Characteristics per MIL-DTL-38999 Contact Arrangements

The following table presents the possible maximum capacitance versus working voltage per MIL-DTL-38999 contact arrangements:

MIL-DTL-38999 Contact Arrangements		Filter Type & Maximum Capacitance			Working Voltage [V _{DC}]	Dielectric Withstanding Voltage [V _{DC}]
		C, CL & LC	C ² & Pi (π)	Hi (2π)		
Series I & III	Series II					
09-35, 11-35, 13-35, 15-35, 17-02⁽¹⁾, 17-35, 19-35, 21-35, 23-35, 25-07, 25-35	08-35, 10-35, 12-35, 14-35, 16-35, 18-35, 20-35, 22-35, 24-35	1μF	2μF	1.94μF	6.3V	15.75V
		330nF	660nF	630nF	10V	25V
		150nF	300nF	286nF	25V	62.5V
		100nF	200nF	194nF	50V	125V
		22nF	44nF	42nF	100V	250V
		10nF	20nF	19.4nF	200V	500V
		6.8nF	13.6nF	13.4nF	250V	500V
09-98, 11-05, 11-98, 11-99, 13-08, 13-98, 15-15, 15-18, 15-19, 15-97⁽²⁾, 17-08, 17-26, 17-99, 19-28, 19-32, 21-16, 21-39, 21-41, 23-21, 23-53, 23-55, 25-04, 25-29, 25-46⁽³⁾⁽⁴⁾, 25-61	08-98, 10-05, 10-98, 10-99, 12-08, 12-98, 14-15, 14-18, 14-97⁽²⁾, 16-08, 16-26, 16-99, 18-28, 18-32, 20-16, 20-39, 20-41, 22-21, 22-53, 22-55, 24-04, 24-29, 24-61	1μF	2μF	1.94μF	6.3V	15.75V
		470nF	940nF	910nF	16V	40V
		220nF	440nF	420nF	25V	62.5V
		100nF	200nF	194nF	50V	125V
		68nF	136nF	134nF	100V	250V
		33nF	66nF	63nF	200V	500V
		27nF	54nF	51nF	250V	500V
		15nF	30nF	28.6nF	300V	750V
		12nF	24nF	23.2nF	500V	750V
		8.2nF	16.4nF	16nF	600V	750V
		4.7nF	9.4nF	9.1nF	800V	960V
2.7nF	5.4nF	5.1nF	1000V	1200V		
13-04, 15-05, 15-97⁽³⁾, 17-02⁽⁴⁾, 17-06, 21-11, 21-75, 25-07⁽⁴⁾, 25-19, 25-46⁽⁴⁾	12-04, 14-05, 14-97⁽³⁾, 16-06, 18-28, 24-19	3μF	6μF	5.82μF	6.3V	15.75V
		1.41μF	2.82μF	2.73μF	16V	40V
		660nF	1.32μF	1.26μF	25V	62.5V
		300nF	600nF	582nF	50V	125V
		204nF	408nF	402nF	100V	250V
		99nF	198nF	189nF	200V	500V
		81nF	162nF	153nF	250V	500V
		45nF	90nF	85.8nF	300V	750V
		36nF	72nF	69.6nF	500V	750V
		24.6nF	49.2nF	48nF	600V	750V
		14.1nF	28.2nF	27.3nF	800V	960V
8.1nF	16.2nF	15.3nF	1000V	1200V		

- (1) - refers to #22 contacts
- (2) - refers to #20 contacts
- (3) - refers to #16 contacts
- (4) - refers to #8 contacts

This table can be used in two ways:

- Once a contact arrangements is selected, by using this table the capacitance and the working voltage limits can be extracted.
- Once the correct filter type and working voltage are selected, by using this table the complying contact arrangements can be determined to meet the design requirements.

Notes: Filtered connector combined with transient protection will achieve lower capacitance levels. In several contact arrangements, higher capacitance is available with or without protection. For more details contact the sales department.

Transient Protection Characteristics per MIL-DTL-38999 Contact Arrangements

The following table presents the possible maximum transient protection energy versus selected filter type and working voltage per MIL-DTL-38999 contact arrangements:

Max. Transient Protection Energy @ 10x1000 μ S waveform vs. Working Voltage.

MIL-DTL-38999 Contact Arrangements		Filter Type & Maximum Transient Protection Energy			Working Voltage [V _{DC}]	Working Voltage [V _{AC}]
Series I & III	Series II	No Filter	C, CL & LC	C ² & Pi (π)		
09-35, 11-35, 13-35, 15-35, 17-02 ⁽¹⁾ , 17-35, 19-35, 21-35, 23-35, 25-07, 25-35	08-35, 10-35, 12-35, 14-35, 16-35, 18-35, 20-35, 22-35, 24-35	0.3J	0.2J	0.1J	3.3V	2.3V
		0.3J	0.2J	0.1J	5.6V	4V
		0.3J	0.2J	0.1J	9V	6.4V
		0.3J	0.2J	0.1J	14V	10V
		0.3J	0.2J	0.1J	18V	13V
		0.3J	0.2J	0.1J	26V	18V
		0.3J	0.2J	0.1J	30V	21V
09-98, 11-05, 11-98, 11-99, 13-08, 13-98, 15-15, 15-18, 15-19, 15-97 ⁽²⁾ , 17-08, 17-26, 17-99, 19-28, 19-32, 21-16, 21-39, 21-41, 23-21, 23-53, 23-55, 25-04, 25-29, 25-46 ⁽³⁾⁽⁴⁾ , 25-61	08-98, 10-05, 10-98, 10-99, 12-08, 12-98, 14-15, 14-18, 14-97 ⁽²⁾ , 16-08, 16-26, 16-99, 18-28, 18-32, 20-16, 20-39, 20-41, 22-21, 22-53, 22-55, 24-04, 24-29, 24-61	0.9J	0.6J	0.3J	3.3V	2.3V
		0.9J	0.6J	0.3J	5.6V	4V
		0.3J	0.2J	0.1J	9V	6.4V
		0.9J	0.6J	0.3J	12V	8.5V
		0.9J	0.6J	0.3J	14V	10V
		0.9J	0.6J	0.3J	18V	13V
		0.9J	0.6J	0.3J	26V	18V
		0.3J	0.2J	0.1J	30V	21V
		13-04, 15-05, 15-97 ⁽³⁾ , 17-02 ⁽⁴⁾ , 17-06, 21-11, 21-75, 25-07 ⁽⁴⁾ , 25-19, 25-46 ⁽⁴⁾	12-04, 14-05, 14-97 ⁽³⁾ , 16-06, 18-28, 24-19	2.7J	1.8J	0.9J
2.7J	1.8J			0.9J	5.6V	4V
0.9J	0.6J			0.3J	9V	6.4V
2.7J	1.8J			0.9J	12V	8.5V
2.7J	1.8J			0.9J	14V	10V
2.7J	1.8J			0.9J	18V	13V
2.7J	1.8J			0.9J	26V	18V
0.9J	0.6J			0.3J	30V	21V

MIL-DTL-38999
Series I, II, III

* For higher energy contact sales.

(1) - refers to #22 contacts

(2) - refers to #20 contacts

(3) - refers to #16 contacts

(4) - refers to #8 contacts

This table can be used in two ways:

- Once a contact arrangements is selected, by using this table the energy and the working voltage limits can be extracted.
- Once the correct energy and working voltage are selected, by using this table the complying filter type and contact arrangements can be determined to meet the design requirements.

Notes: Filtered connector combined with transient protection will achieve lower capacitance levels. In several contact arrangements, higher energy is available with or without filter. For more details contact the sales department.

MIL-DTL-26482 Series II

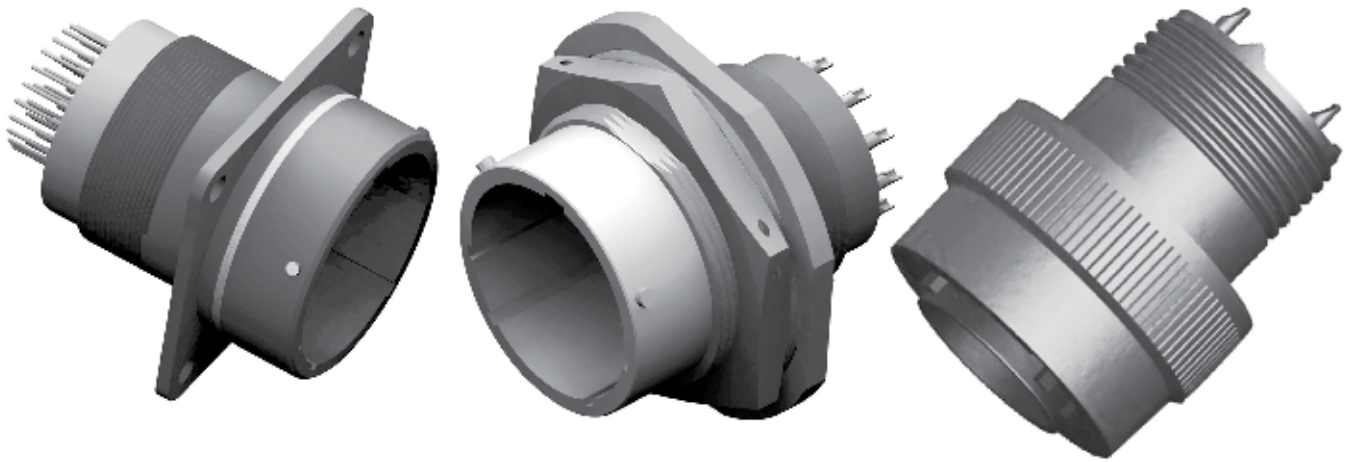

This series is identical to the obsolete MIL-C-83723 Series I, which is used in existing applications.

The MIL-DTL-26482 Series II connectors are based on bayonet coupling configuration. These connectors are offered with 20, 16, 12 size contacts in shell sizes of 8 to 24.

Square flange, Jam Nut receptacles and Plugs are available in Stainless Steel passivated or Aluminium shells with Electroless Nickel, Olive Drab Cadmium or Zinc-Cobalt plating.

The filtered connectors are fully intermatable with non-filtered and can be drop-in replacements for non-filtered connectors.

Non-standard connector body sizes, shapes and contact arrangements are available.

Material & Finish

Part	Material & Finish	Part	Material & Finish
Connector Shell	Aluminium alloy, Olive drab Cadmium plated	Contacts	Copper alloy, Gold plated 1.27 μm
	Aluminium alloy, Electroless Nickel plated		(50 μInch) Min. over Electroless Nickel
	Aluminium alloy, Zinc-Cobalt plated		
	Stainless Steel, passivated		
Insulator	High Grade Thermoplastic / Thermoset / Epoxy	Contacts Termination:	
Grommet & O-ring	Silicon based elastomer	PCB tail	Gold plated or Tin plated (pretinned)
		Solder Cup	Copper alloy, Tin plated

Content of Section

	Page
How To Order	17
Insert arrangements	18
Key Position	19
Termination types	20
Environmental Conditions	20
Shell types	21-22
Electrical Characteristics	23-24

How To Order

B 2 F 14 K 05 P 1 N 06 CC30

FAMILY

B- MIL-DTL-26482

SERIES

2- Series II

SHELL STYLE

J - Jam Nut receptacle	P - Plug
W - Wall Mount receptacle	A - Adaptor Receptacle to Plug ⁽²⁾
C - Wall Mount + Clinch Nut	R - Adaptor Receptacle to Receptacle
F - Wall Mount Wide Flange receptacle	S - Special

SHELL SIZE

Series II - 08-10-12-14-16-18-20-22-24

MATERIAL & FINISH

F - Aluminum Alloy, Electroless Nickel Plating
K - Stainless Steel, Passivated, Corrosion resistant, without Firewall Capability
W - Aluminum Alloy, Olive drab Cadmium Plating
ZC - Aluminum Alloy, Zinc Cobalt Plating
S - Other material and finish options

INSERT ARRANGEMENT

See page 18

CONTACT TYPE

Regular: **P**-Pin⁽¹⁾
S-Socket⁽¹⁾
 Hermetically Sealed: **R**-Pin
U-Socket] (See page 20 - table of Environmental conditions)

TERMINATION: See page 20

1 -Solder Cup	7 - Solder Cup + Exposed teeth	0 - No termination (for Adaptor)
2 -PCB Tail (Tin Plated)	8 - Crimp	
3 -PCB Tail (Gold Plated)	9 -Special	

POLARIZATION

Key Position (See page 19)

WORKING VOLTAGE: See page 37

01 6.3V	07 200V	14 800V	00 - For filters with diversified voltages
02 10V	08 250V	15 1000V	99 - For any configuration that incorporates transient protection
03 16V	09 300V	16 1500V	XX - Without filter
04 25V	10 400V	17 2000V	
05 50V	11 500V		
06 100V	12 600V		

FILTER CODE AND/OR TRANSIENT PROTECTION CODE: See page 37

xxxx - In case where a custom protection is required (diversity of filter types and/or transient protection types) fill XXXX.
 Contact sales for customizing.

MIL-DTL-26482
Series II

(1) For Adaptor shell style indicates the Receptacle side gender. The Plug side gender is by default opposite.
 (2) For Adaptor mechanical dimensions, contact sales.
 * Contact sales for filter connectors not included in this catalog.

Insert Arrangements Per MIL-STD-1669

Numbering example

0833

Shell Size

Insert Arrangement
3#20 (Contact quantity & Size)



0833
3 #20



0898
3 #20



1006
6 #20



1203
3 #16

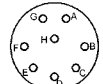

1208
8 #20



1210
10 #20

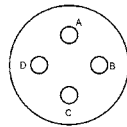

1404
4 #12

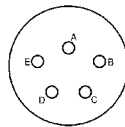

1405
5 #16

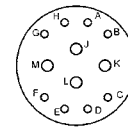

1412
4 #16, 8 #20

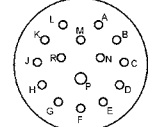

1415
1 #16, 14 #20

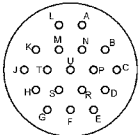

1418
18 #20

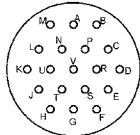

1419
19 #20

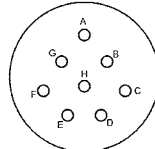

1608
8 #16

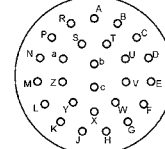

1626
26 #20

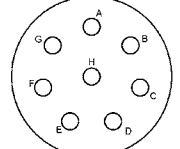

1808
8 #12

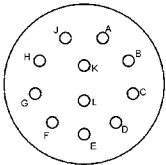

1811
11 #16

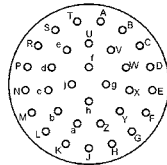

1832
32 #20

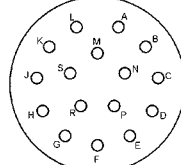

2016
16 #16

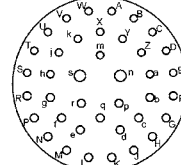

2039
2 #16, 37 #20

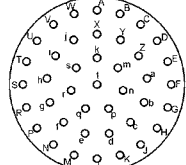

2041
41 #20

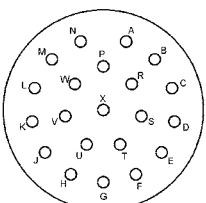

2221
21 #16

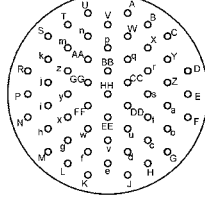

2255
55 #20

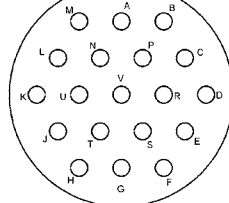

2419
19 #12

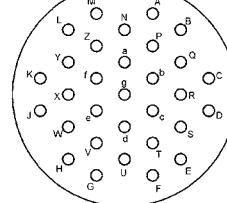

2431
31 #16

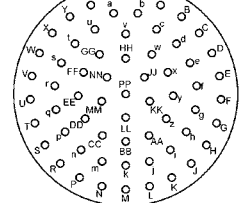

2461
61 #20

* Front face of Pin insert is shown. Socket insert is opposite.
* For other insert arrangements contact sales.

Key Position

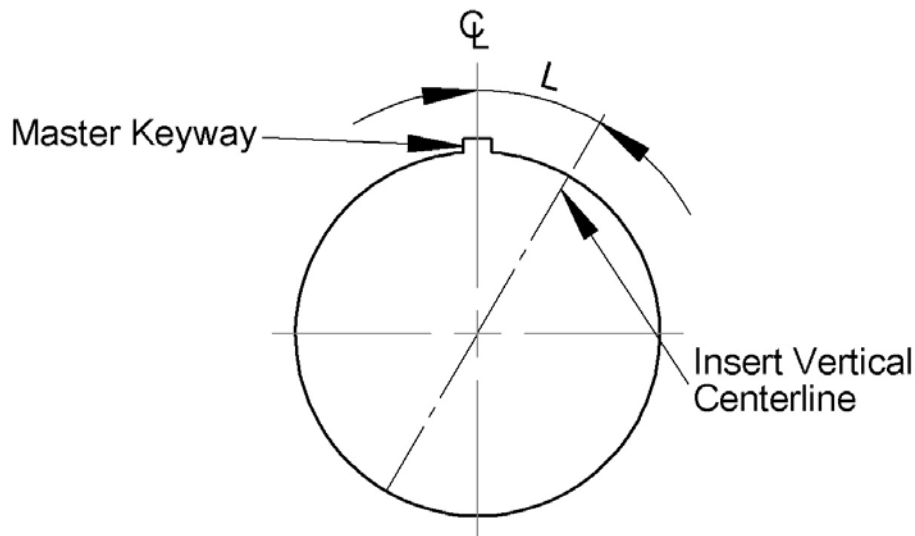

1. In the Normal insert clocking position (position N) the insert centerline coincides with the centerline of the master keyway of the shell.
2. In the alternate insert clocking position (W,X,Y,Z) the pin Insert is rotated clockwise relative to the centerline of the master keyway as indicated in the figure and chart. The socket insert is rotated counter-clockwise.
3. Plugs have keys, receptacles have keyways.

Shell size & Insert Arrangement	L Degrees				
	N	W	X	Y	Z
8-33	0	90	-	-	-
8-98	0	-	-	-	-
10-6	0	90	-	-	-
12-3	0	-	-	180	-
12-8	0	90	112	203	292
12-10	0	60	155	270	295
14-4	0	45	-	-	-
14-5	0	40	92	184	273
14-12	0	43	90	-	-
14-15	0	17	110	155	234
14-18	0	15	90	180	270
14-19	0	30	165	315	-
16-8	0	54	152	180	331
16-26	0	60	-	275	338
18-8	0	180	-	-	-
18-11	0	62	119	241	340
18-32	0	85	138	222	265
20-16	0	238	318	333	347
20-39	0	63	144	252	333
20-41	0	45	126	225	-
22-21	0	16	135	175	349
22-55	0	30	142	226	314
24-19	0	30	165	315	-
24-31	0	90	225	255	-
24-61	0	90	180	270	324

The master key is rotated to provide polarization the minor keys remain fixed.
Insert Arrangement does not rotate with the Key/Keyway.

* contact sales for filter connectors not included in this catalog.

Termination Types & Sizes

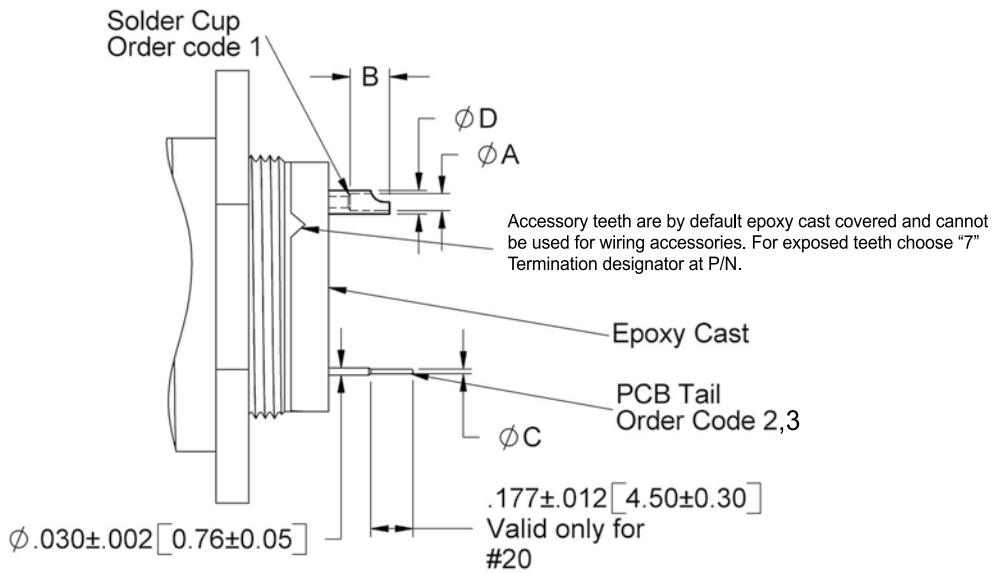

Termination Dimensions

For Termination length refer to specific shell dimensions table – pages 21, 22 – columns H, T

Contact Size	#22	#20	#16	#12
Ø A ± .002	.043	.043	.074	.114
[±0.05]	[1.10]	[1.10]	[1.90]	[2.90]
B ± .012	.126	.126	.149	4.20
[±0.30]	[3.20]	[3.20]	[3.80]	[.165]
Ø C ±.002	.002	.002	.046	2.06
[±0.05]	[0.5]	[0.5]	[1.16]	[.081]
Ø D ± .002	.059	.059	.100	3.60
[±0.05]	[1.50]	[1.50]	[2.54]	[.141]

Environmental Conditions

Description	Values	PARAGRAPH PER			
		ISO 2100	ISO 7137	MIL-STD-1344	MIL-STD- 202
Sealing**	Air Leakage 5×10^{-3} cm ³ / sec at Δ P = 1atm on mated connector				
Vibration (Random)	Up to 40g RMS 20-2000Hz	12		2005.1	201,204,214
Vibration (Sine)	Up to 15g PTP 10-2000Hz	12		2005.1	201,204,214
Shock	100g X 6msec Half Sine		7	2004.1	213
Acceleration	40g	19			
Climatic					103,106
Temperature	-55°C to +125°C Operating & Storage				
Humidity	Up to 95% @ Storage Temperature range	18b		1002.2	
Altitude	Up to 70,000 ft	18a	4		
Salt Spray	500 hours for Aluminium Olive Drab Cadmium plated or Stainless Steel, 48 hours for Aluminium Electroless Nickel or Zinc-Cobalt plated, 1000 hours for Bronze	22		1001.1	101
Sand & Dust		23	12		110
Contact Endurance	More than 500 mating cycles	16			

** For Hermetically sealed connector the leakage is 10^{-5} cm³/sec Helium at Δ P = 1atm

* Dimensions are in Inches. Values in brackets are Millimeters equivalents.

* Dimensions subject to change without prior notice.

B2W Wall Mount Receptacle (MS3470 Compatible)

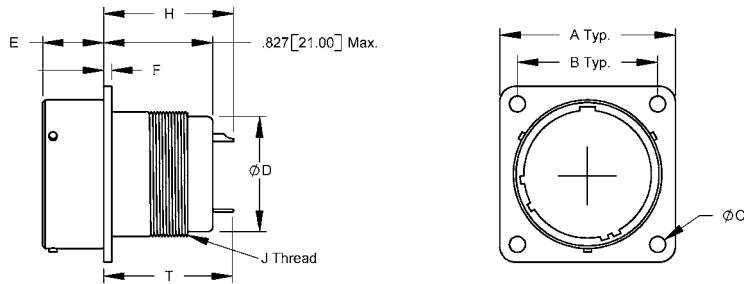

Shell Size	A Max	B ±.005 [±.13]	Ø C ±0.006 [±.15]	Ø D Max	E Max	F ±.016 [±0.4]	J Thread	H Max		T ±.028 [±0.7]
								#22, #20, #16	#12	
8	.828	.594	.120	.500	.462	.062	1/2-20	.984	1.063	1.161
	[21.0]	[15.1]	[3.0]	[12.7]	[11.7]	[1.6]	UNF	[25.0]	[27.0]	[29.5]
10	.954	.719	.120	.625	.462	.062	5/8-20	.984	1.063	1.161
	[24.2]	[18.3]	[3.0]	[15.9]	[11.7]	[1.6]	UNEF	[25.0]	[27.0]	[29.5]
12	1.047	.812	.120	.750	.462	.062	3/4-20	.984	1.063	1.161
	[26.6]	[20.6]	[3.0]	[19.1]	[11.7]	[1.6]	UNEF	[25.0]	[27.0]	[29.5]
14	1.141	.906	.120	.875	.462	.062	7/8-20	.984	1.063	1.161
	[29.0]	[23.0]	[3.0]	[22.2]	[11.7]	[1.6]	UNEF	[25.0]	[27.0]	[29.5]
16	1.234	.969	.120	1.000	.462	.062	1-20	.984	1.063	1.161
	[31.4]	[24.6]	[3.0]	[25.4]	[11.7]	[1.6]	UNEF	[25.0]	[27.0]	[29.5]
18	1.328	1.062	.120	1.063	.462	.062	1-1/16-	.984	1.063	1.161
	[33.7]	[27.0]	[3.0]	[27.0]	[11.7]	[1.6]	18 UNEF	[25.0]	[27.0]	[29.5]
20	1.453	1.156	.120	1.875	.587	.094	1-3/16-	.984	1.063	1.161
	[36.9]	[29.4]	[3.0]	[30.2]	[14.9]	[2.4]	18 UNEF	[25.0]	[27.0]	[29.5]
22	1.578	1.250	.120	1.3125	.587	.094	1-5/16-	.984	1.063	1.161
	[40.1]	[31.8]	[3.0]	[33.3]	[14.9]	[2.4]	18 UNEF	[25.0]	[27.0]	[29.5]
24	1.703	1.375	.147	1.4375	.587	.094	1-7/16-	.984	1.063	1.161
	[43.3]	[34.9]	[3.7]	[36.5]	[14.9]	[2.4]	18 UNEF	[25.0]	[27.0]	[29.5]

B2F Wall Mount Receptacle Wide Flange (MS3472 Compatible)

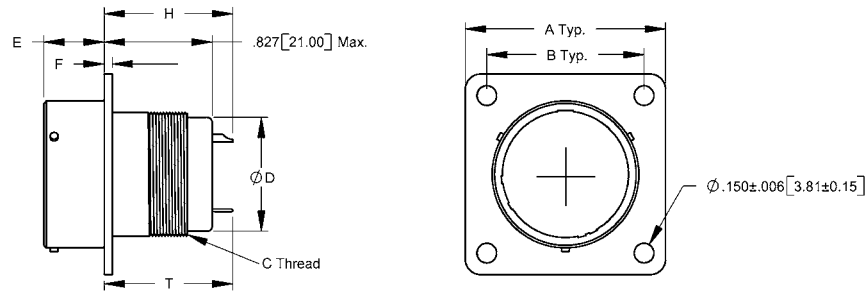

Shell Size	A Max	B ±.005 [±.13]	C Thread	Ø D Max	E Max	F ±.016 [±0.4]	H Max		T ±.028 [±0.7]
							#22, #20, #16	#12	
8	1.065	.734	1/2-20	.500	.493	.062	1.000	1.079	1.132
	[27.1]	[18.6]	UNF	[12.7]	[12.5]	[1.6]	[25.4]	[27.4]	[28.8]
10	1.141	.812	5/8-20	.625	.493	.062	1.000	1.079	1.132
	[29.0]	[20.6]	UNEF	[15.9]	[12.5]	[1.6]	[25.4]	[27.4]	[28.8]
12	1.266	.938	3/4-20	.750	.493	.062	1.000	1.079	1.132
	[32.2]	[23.8]	UNEF	[19.1]	[12.5]	[1.6]	[25.4]	[27.4]	[28.8]
14	1.360	1.031	7/8-20	.875	.493	.062	1.000	1.079	1.132
	[34.6]	[26.2]	UNEF	[22.2]	[12.5]	[1.6]	[25.4]	[27.4]	[28.8]
16	1.453	1.125	1-20	1.000	.493	.062	1.000	1.079	1.132
	[36.9]	[28.6]	UNEF	[25.4]	[12.5]	[1.6]	[25.4]	[27.4]	[28.8]
18	1.532	1.203	1-1/16-18	1.063	.493	.062	1.000	1.079	1.132
	[38.9]	[30.6]	UNEF	[27.0]	[12.5]	[1.6]	[25.4]	[27.4]	[28.8]
20	1.688	1.297	1-3/16-18	1.875	.587	.094	1.000	1.079	1.037
	[42.9]	[32.9]	UNEF	[30.2]	[14.9]	[2.4]	[25.4]	[27.4]	[26.4]
22	1.766	1.375	1-5/16-18	1.3125	.587	.094	1.000	1.079	1.037
	[44.9]	[34.9]	UNEF	[33.3]	[14.9]	[2.4]	[25.4]	[27.4]	[26.4]
24	1.891	1.500	1-7/16-18	1.4375	.587	.094	1.000	1.079	1.037
	[48.0]	[38.1]	UNEF	[36.5]	[14.9]	[2.4]	[25.4]	[27.4]	[26.4]

* For panel cutout dimensions refer to pages 34-35.
 * Dimensions are in Inches. Values in brackets are Millimeters equivalents.
 * Dimensions subject to change without prior notice.

B2J Jam Nut Receptacle (MS3474 Compatible)

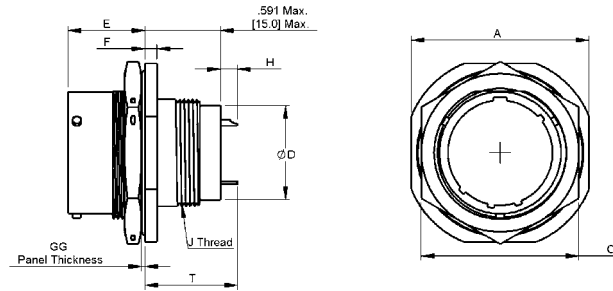

Shell Size	A Max	C Max	Ø D Max	E	F	GG	J Thread	H ± .039 [±1.0]		T ± .028 [±0.7]
								#22, #20, #16	#12	
8	.954	.767	.500	.658/.707	.086/.113	.062/.187	1/2-20	.138	.217	.886
	[24.2]	[19.5]	[12.7]	[17.6/18.0]	[2.2/2.9]	[1.6/4.8]	UNF	[3.5]	[5.5]	[22.5]
10	1.078	.892	.625	.658/.707	.086/.113	.062/.187	5/8-20	.138	.217	.886
	[27.4]	[22.7]	[15.9]	[17.6/18.0]	[2.2/2.9]	[1.6/4.8]	UNEF	[3.5]	[5.5]	[22.5]
12	1.266	1.079	.750	.658/.707	.086/.113	.062/.187	3/4-20	.138	.217	.886
	[32.2]	[27.4]	[19.1]	[17.6/18.0]	[2.2/2.9]	[1.6/4.8]	UNEF	[3.5]	[5.5]	[22.5]
14	1.391	1.205	.875	.658/.707	.086/.113	.062/.187	7/8-20	.138	.217	.886
	[35.3]	[30.6]	[22.2]	[17.6/18.0]	[2.2/2.9]	[1.6/4.8]	UNEF	[3.5]	[5.5]	[22.5]
16	1.516	1.329	1.000	.658/.707	.086/.113	.062/.187	1-20	.138	.217	.886
	[38.5]	[33.8]	[25.4]	[17.6/18.0]	[2.2/2.9]	[1.6/4.8]	UNEF	[3.5]	[5.5]	[22.5]
18	1.641	1.455	1.063	.658/.707	.086/.113	.062/.187	1-1/16-18	.138	.217	.886
	[41.7]	[37.0]	[27.0]	[17.6/18.0]	[2.2/2.9]	[1.6/4.8]	UNEF	[3.5]	[5.5]	[22.5]
20	1.828	1.579	1.875	.721/.772	.096/.148	.062/.250	1-3/16-18	.138	.217	.823
	[46.4]	[40.1]	[30.2]	[18.3/19.6]	[2.4/3.8]	[1.6/5.6]	UNEF	[3.5]	[5.5]	[20.9]
22	1.954	1.705	1.3125	.721/.772	.096/.148	.062/.250	1-5/16-18	.138	.217	.823
	[49.6]	[43.3]	[33.3]	[18.3/19.6]	[2.4/3.8]	[1.6/5.6]	UNEF	[3.5]	[5.5]	[20.9]
24	2.078	1.829	1.4375	.721/.772	.096/.148	.062/.250	1-7/16-18	.138	.217	.823
	[52.8]	[46.5]	[36.5]	[18.3/19.6]	[2.4/3.8]	[1.6/5.6]	UNEF	[3.5]	[5.5]	[20.9]

B2P Plug Shell (MS3475 Compatible)

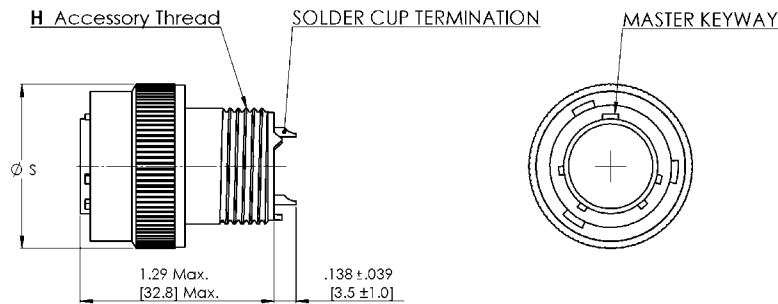

Shell Size	H Thread	S Max.
8	.5000-20	.782
	UNF	[19.9]
10	.6250-24	.926
	UNEF	[23.5]
12	.7500-20	1.043
	UNEF	[26.5]
14	.8750-20	1.183
	UNEF	[30.1]
16	1.000-20	1.305
	UNEF	[33.2]
18	1.0625-18	1.391
	UNEF	[35.3]
20	1.1875-18	1.531
	UNEF	[38.9]
22	1.3125-18	1.656
	UNEF	[42.1]
24	1.4375-18	1.777
	UNEF	[45.1]

* For panel cutout dimensions refer to pages 34-35.
 * Dimensions are in Inches. Values in brackets are Millimeters equivalents.
 * Dimensions subject to change without prior notice.

MIL-DTL-26482 Series II

Filter Electrical Characteristics per MIL-DTL-26482 contact arrangements

The following table presents the possible maximum capacitance versus working voltage per MIL-DTL-26482 contact arrangements:

MIL-DTL-26482 contact arrangements	Filter Type & Maximum Capacitance			Working Voltage [V _{DC}]	Dielectric Withstanding Voltage [V _{DC}]
	C, CL & LC	C ² & Pi (π)	Hi (2π)		
Series II 08-33, 08-98, 10-06, 12-08, 12-10, 14-12⁽¹⁾, 14-15⁽¹⁾, 14-18, 14-19, 16-26, 18-32, 20-39⁽¹⁾, 20-41, 22-55, 24-61	1μF	2μF	1.94μF	6.3V	15.75V
	470nF	940nF	910nF	16V	40V
	220nF	440nF	420nF	25V	62.5V
	100nF	200nF	194nF	50V	125V
	68nF	136nF	134nF	100V	250V
	33nF	66nF	63nF	200V	500V
	27nF	54nF	51nF	250V	500V
	15nF	30nF	28.6nF	300V	750V
	12nF	24nF	23.2nF	500V	750V
	8.2nF	16.4nF	16nF	600V	750V
	4.7nF	9.4nF	9.1nF	800V	960V
	2.7nF	5.4nF	5.1nF	1000V	1200V
12-03, 14-04, 14-05, 14-12⁽²⁾, 14-15⁽²⁾, 16-08, 18-08, 18-11, 20-16, 20-39⁽²⁾, 22-21, 24-19, 24-31	3μF	6μF	5.82μF	6.3V	15.75V
	1.41μF	2.82μF	2.73μF	16V	40V
	660nF	1.32μF	1.26μF	25V	62.5V
	300nF	600nF	582nF	50V	125V
	204nF	408nF	402nF	100V	250V
	99nF	198nF	189nF	200V	500V
	81nF	162nF	153nF	250V	500V
	45nF	90nF	85.8nF	300V	750V
	36nF	72nF	69.6nF	500V	750V
	24.6nF	49.2nF	48nF	600V	750V
	14.1nF	28.2nF	27.3nF	800V	960V
	8.1nF	16.2nF	15.3nF	1000V	1200V

⁽¹⁾ - refers to #20 contacts

⁽²⁾ - refers to #16 contacts

This table can be used in two ways:

- Once a contact arrangements is selected, by using this table the capacitance and the working voltage limits can be extracted.
- Once the correct filter type and working voltage are selected, by using this table the complying contact arrangements can be determined to meet the design requirements.

Notes: Filtered connector combined with transient protection will achieve lower capacitance levels. In several contact arrangements, higher capacitance is available with or without protection. For more details contact the sales department.

Transient Protection Characteristics per MIL-DTL-26482 contact arrangements

The following table presents the possible maximum transient protection energy versus selected filter type and working voltage per MIL-DTL-26482 contact arrangements:

Max. Transient Protection Energy @ 10x1000µS waveform vs. Working Voltage.

MIL-DTL-26482 contact arrangements	Filter Type & Maximum Transient Protection Energy			Working Voltage [V _{DC}]	Working Voltage [V _{AC}]
	No Filter	C, CL & LC	C ² & Pi (π)		
Series II					
08-33, 08-98, 10-06, 12-08, 12-10, 14-12 ⁽¹⁾ , 14-15 ⁽¹⁾ , 14-18, 14-19, 16-26, 18-32, 20-39 ⁽¹⁾ , 20-41, 22-55, 24-61	0.9J	0.6J	0.3J	3.3V	2.3V
	0.9J	0.6J	0.3J	5.6V	4V
	0.3J	0.2J	0.1J	9V	6.4V
	0.9J	0.6J	0.3J	12V	8.5V
	0.9J	0.6J	0.3J	14V	10V
	0.9J	0.6J	0.3J	18V	13V
	0.9J	0.6J	0.3J	26V	18V
	0.3J	0.2J	0.1J	30V	21V
12-03, 14-04, 14-05, 14-12 ⁽²⁾ , 14-15 ⁽²⁾ , 16-08, 18-08, 18-11, 20-16, 20-39 ⁽²⁾ , 22-21, 24-19, 24-31	2.7J	1.8J	0.9J	3.3V	2.3V
	2.7J	1.8J	0.9J	5.6V	4V
	0.9J	0.6J	0.3J	9V	6.4V
	2.7J	1.8J	0.9J	12V	8.5V
	2.7J	1.8J	0.9J	14V	10V
	2.7J	1.8J	0.9J	18V	13V
	2.7J	1.8J	0.9J	26V	18V
	0.9J	0.6J	0.3J	30V	21V

* For higher energy contact sales.

(1) - refers to #20 contacts

(2) - refers to #16 contacts

This table can be used in two ways:

- Once a contact arrangements is selected, by using this table the energy and the working voltage limits can be extracted.
- Once the correct energy and working voltage are selected, by using this table the complying filter type and contact arrangements can be determined to meet the design requirements.

Notes: Filtered connector combined with transient protection will achieve lower capacitance levels.

In several contact arrangements, higher energy is available with or without filter.

For more details contact the sales department.

MIL-DTL-83723 Series III



MIL-DTL-83723
Series III

This series offers a large diversity in one connectors group.

The Series III offers connectors with one of bayonet, threaded or quick-disconnect coupling systems. The MIL-DTL-83723 Series III connectors are offered in arrangements with 2 to 61 contacts of 20, 16 or 12 size contacts in shell sizes of 8 to 24.

Square flange, Jam Nut receptacles and Plugs are available in Stainless Steel passivated or Aluminium shells with Electroless Nickel, Olive Drab Cadmium or Zinc-Cobalt plating. The filtered connectors are fully intermatable with non-filtered and can be drop-in replacements for non-filtered connectors.

Non-standard connector body sizes, shapes and contact arrangements are available.

Material & Finish

Part	Material & Finish	Part	Material & Finish
Connector Shell	Aluminium alloy, Olive drab Cadmium plated	Contacts	Copper alloy, Gold plated 1.27 µm (50 µInch) Min. over Electroless Nickel
	Aluminium alloy, Electroless Nickel plated		
	Aluminium alloy, Zinc-Cobalt plated		
	Stainless Steel, passivated		
Insulator	High Grade Thermoplastic / Thermoset / Epoxy	Contacts Termination:	Gold plated or Tin plated (pretinned)
Grommet & O-ring	Silicon based elastomer		Solder Cup

Content of Section

	Page
How To Order	26
Insert arrangements	27
Key Position	28
Termination types	29
Environmental Conditions	29
Shell types	30-31
Electrical Characteristics	32-33

How To Order**D 3 J 24 W 61 P 1 N 99 YB54****FAMILY**

- D** - MIL-DTL-83723/III Bayonet Coupling
- E** - MIL-DTL-83723/III Threaded Coupling (For dimensions consult factory)

SERIES

3 - Series III

SHELL STYLE

- | | |
|------------------------------------|--|
| J - Jam Nut receptacle | A - Adaptor Receptacle to Plug ⁽²⁾ |
| W - Wall Mount receptacle | R - Adaptor Receptacle to Receptacle |
| C - Wall Mount + Clinch Nut | S - Special |
| P - Plug | |

SHELL SIZE

Series III - 08-10-12-14-16-18-20-22-24

MATERIAL & FINISH

- F** - Aluminum Alloy, Electroless Nickel Plating
- K** - Stainless Steel, Passivated, Corrosion resistant, without Firewall Capability
- W** - Aluminum Alloy, Olive drab Cadmium Plating
- ZC** - Aluminum Alloy, Zinc Cobalt Plating
- S** - Other material and finish options

INSERT ARRANGEMENT

(See page 27)

CONTACT TYPE

- Regular: **P**-Pin⁽¹⁾
S-Socket⁽¹⁾
- Hermetically Sealed: **R**-Pin
U-Socket] (See page 29 - table of Environmental conditions)

TERMINATION: See page 29

- | | | |
|------------------------------|---------------------------------------|---|
| 1 - Solder Cup | 7 - Solder Cup + Exposed teeth | 0 - No termination (for Adaptor) |
| 2 - PCB (Tin Plated) | 8 - Crimp | |
| 3 - PCB (Gold Plated) | 9 - Special | |

POLARIZATION

Key Position (See page 28)

WORKING VOLTAGE: See page 37

- | | | | |
|----------------|----------------|-----------------|--|
| 01 6.3V | 07 200V | 14 800V | 00 - For filters with diversified voltages |
| 02 10V | 08 250V | 15 1000V | 99 - For any configuration that incorporates transient protection |
| 03 16V | 09 300V | 16 1500V | XX - Without filter |
| 04 25V | 10 400V | 17 2000V | |
| 05 50V | 11 500V | | |
| 06 100V | 12 600V | | |

FILTER CODE AND/OR TRANSIENT PROTECTION CODE: See page 37

xxxx - In case where a custom protection is required (diversity of filter types and/or transient protection types) fill XXXX.
 Contact sales for customizing.

(1) For Adaptor shell style indicates the Receptacle side gender. The Plug side gender is by default opposite.

(2) For Adaptor mechanical dimensions, contact sales.

* Contact sales for filter connectors not included in this catalog.

Insert Arrangements Per MIL-STD-1554

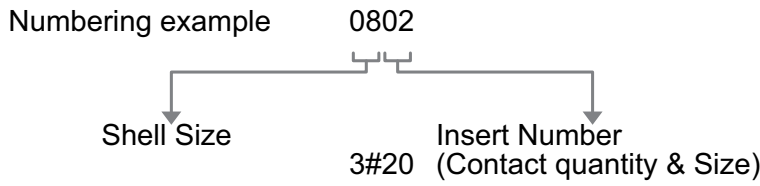

0803
3 #20



0898
3 #20



1002
2 #20



1005
5 #20



1006
6 #20



1020
2 #16

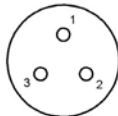

1203
3 #16

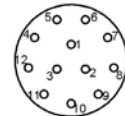

1212
12 #20

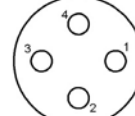

1404
4 #12

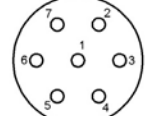

1407
7 #16

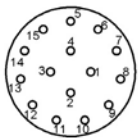

1415
15 #20

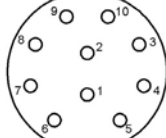

1610
10 #16

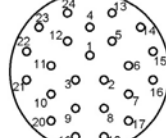

1624
20 #20

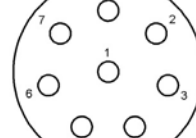

1808
8 #12

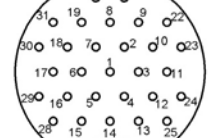

1831
31 #20

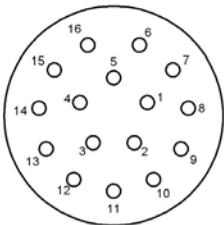

2016
16 #16

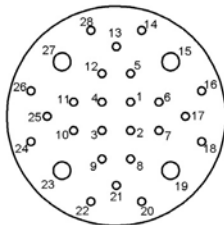

2028
24 #20, 4 #12

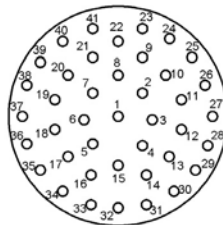

2041
41 #20

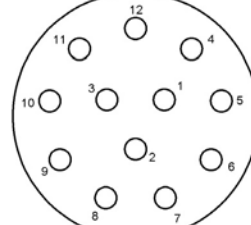

2212
12 #12

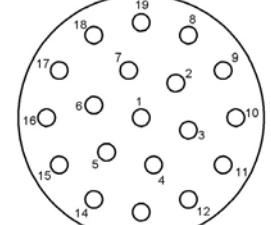

2219
19 #16

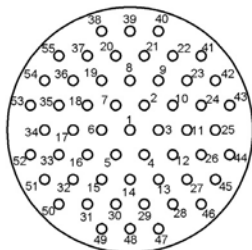

2255
55 #20

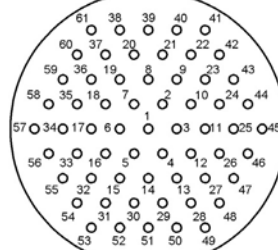

2461
61 #20

*Front face of Pin insert is shown. Socket insert is opposite.
 *For other insert arrangements contact sales.

Key Position

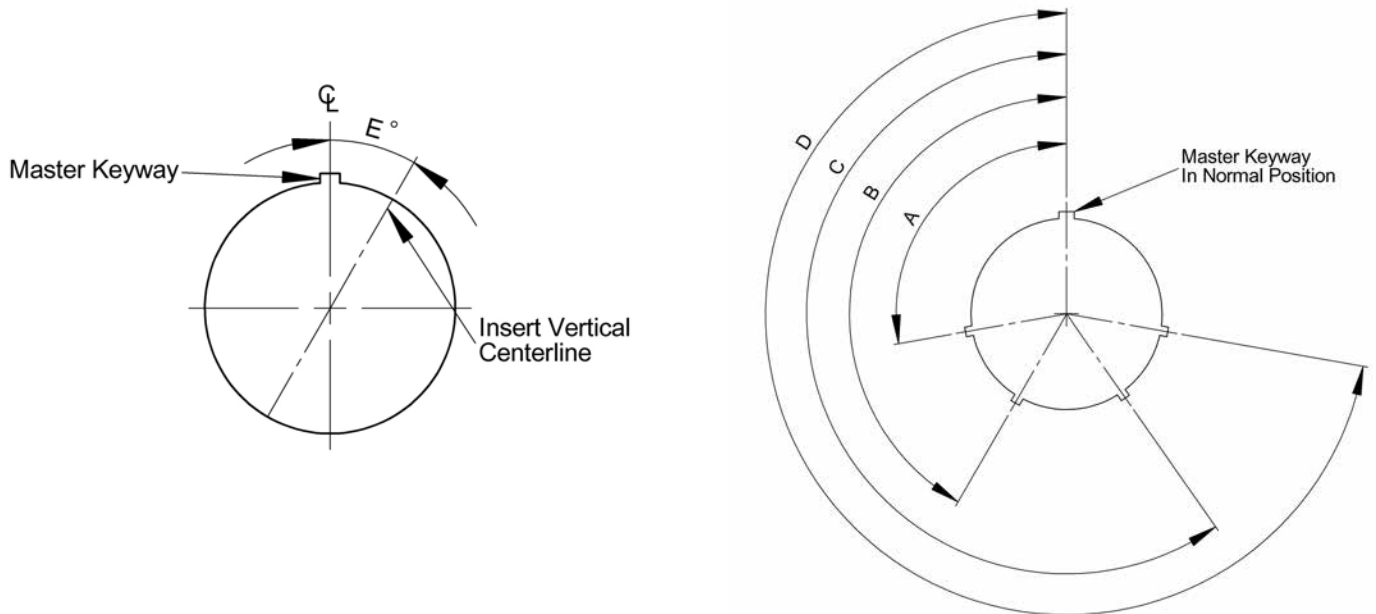

Insert Clocking Per MIL-STD-1554

Shell Size	Polarizing Position	A	B	C	D	Insert Position E
8,10	N	105	140	215	265	0
	1*	105	140	215	265	10
	2*	105	140	215	265	20
	3*	105	140	215	265	30
	4*	105	140	215	265	40
12 Thru 24	5*	105	140	215	265	50
	N	105	140	215	265	0
	1*	105	140	215	265	10
	2*	105	140	215	265	20
	3*	105	140	215	265	30
	4*	105	140	215	265	40
	5*	105	140	215	265	50

Keying Position Per MIL-STD-1554

Shell Size	Polarizing Position	A	B	C	D	Insert Position E
8 Thru 24	N	105	140	215	265	0
8 & 10	6	102	132	248	320	0
	7	80	118	230	312	0
	8	35	140	205	275	0
	9	64	155	234	304	0
10 Only	Y	25	115	220	270	0
12 Thru 24	6	18	149	192	259	0
	7	92	152	222	342	0
	8	84	152	204	334	0
	9	24	135	199	240	0
	Y	98	152	268	338	0

* Position 1 thru 5 inactive for new design, (Ref MIL-STD-1554).

1. In the "normal insert position" (position N) the insert centerline coincides with the centerline of the master keyway of the shell.
2. In the "alternate insert position" (1,2,3,4 & 5) the socket insert is rotated clockwise relative to the centerline of the master keyway as indicated in the figure and chart. The pin insert is rotated counter-clockwise.
3. Alternate polarizing positions 1,2,3,4 & 5 are for interchangeability use only. Not recommended for new design, per MIL-DTL-83723.
4. In the "alternate keying position" (positions 6, 7, 8, 9 & Y) the keyways are positioned as specified in the "Keying position" table with respect to the master keyway as shown in the drawing.
5. When the alternate keying position is used the insert clocking is always in the normal position.

Termination Types

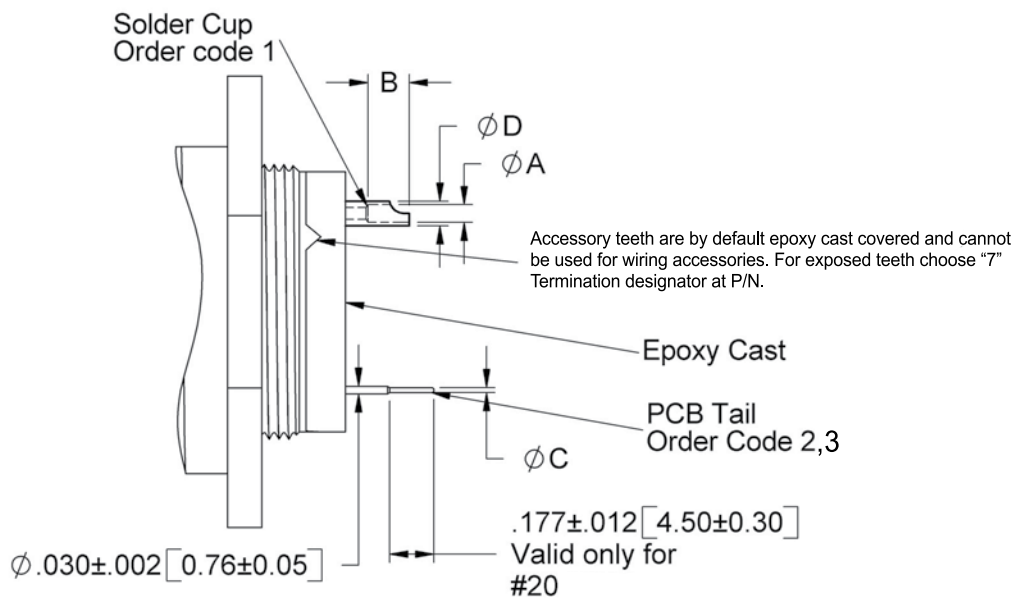

Termination Dimensions

For Termination length refer to specific shell dimensions table – page 30 – columns H, T

Contact Size	#22	#20	#16	#12
$\phi A \pm .002$ [±0.05]	.043 [1.10]	.043 [1.10]	.074 [1.90]	.114 [2.90]
$B \pm .012$ [±0.30]	.126 [3.20]	.126 [3.20]	.149 [3.80]	4.20 [1.165]
$\phi C \pm .002$ [±0.05]	.002 [0.5]	.002 [0.5]	.046 [1.16]	2.06 [0.81]
$\phi D \pm .002$ [±0.05]	.059 [1.50]	.059 [1.50]	.100 [2.54]	3.60 [1.141]

Environmental Conditions

Description	Values	PARAGRAPH PER			
		ISO 2100	ISO 7137	MIL-STD-1344	MIL-STD- 202
Sealing**	Air Leakage 5×10^{-3} cm ³ / sec at $\Delta P = 1$ atm on mated connector				
Vibration (Random)	Up to 40g RMS 20-2000Hz	12		2005.1	201,204,214
Vibration (Sine)	Up to 15g PTP 10-2000Hz	12		2005.1	201,204,214
Shock	100g X 6msec Half Sine		7	2004.1	213
Acceleration	40g	19			
Climatic					103,106
Temperature	-55°C to +125°C Operating & Storage				
Humidity	Up to 95% @ Storage Temperature range	18b		1002.2	
Altitude	Up to 70,000 ft	18a	4		
Salt Spray	500 hours for Aluminium Olive Drab Cadmium plated or Stainless Steel, 48 hours for Aluminium Electroless Nickel or Zinc-Cobalt plated, 1000 hours for Bronze	22		1001.1	101
Sand & Dust		23	12		110
Contact Endurance	More than 500 mating cycles	16			

** For Hermetically sealed connector the leakage is 10^{-5} cm³/sec Helium at $\Delta P = 1$ atm

* Dimensions are in Inches. Values in brackets are Millimeters equivalents.

* Dimensions subject to change without prior notice.

D3W Wall Mount Receptacle (MS83723 / 71&72 Compatible)

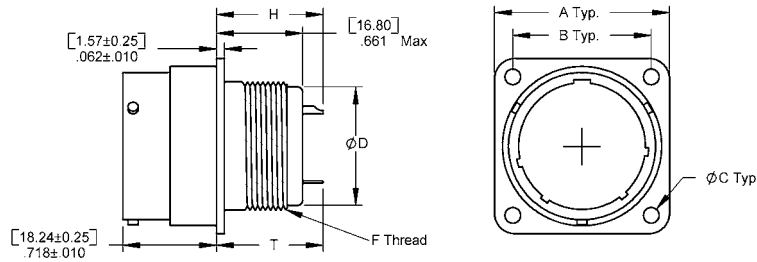

Shell Size	A ± 0.13 [$\pm .005$]	B ± 0.13 [$\pm .005$]	$\phi C \pm 0.13$ [$\pm .005$]	ϕD Max	F Thread	H Max		T $\pm .028$ [± 0.7]
						#22, #20, #16	#12	
8	.812 [20.6]	.594 [15.1]	.120 [3.05]	.500 [12.7]	1/2-20 UNEF	.799 [20.3]	.878 [22.3]	.965 [24.5]
10	.937 [23.8]	.719 [18.3]	.120 [3.05]	.625 [15.9]	5/8-20 UNEF	.799 [20.3]	.878 [22.3]	.965 [24.5]
12	1.031 [26.2]	.812 [20.6]	.120 [3.05]	.750 [19.1]	3/4-20 UNEF	.799 [20.3]	.878 [22.3]	.965 [24.5]
14	1.125 [28.6]	.906 [23.0]	.120 [3.05]	.875 [22.2]	7/8-20 UNEF	.799 [20.3]	.878 [22.3]	.965 [24.5]
16	1.250 [31.8]	.969 [24.6]	.120 [3.05]	1.000 [25.4]	1-20 UNEF	.799 [20.3]	.878 [22.3]	.965 [24.5]
18	1.343 [34.1]	1.062 [27.0]	.120 [3.05]	1.063 [27.0]	1-1/16-18 UNEF	.799 [20.3]	.878 [22.3]	.965 [24.5]
20	1.437 [36.5]	1.156 [29.4]	.120 [3.05]	1.188 [30.2]	1-3/16-18 UNEF	.799 [20.3]	.878 [22.3]	.965 [24.5]
22	1.562 [39.7]	1.250 [31.8]	.120 [3.05]	1.313 [33.3]	1-5/16-18 UNEF	.799 [20.3]	.878 [22.3]	.965 [24.5]
24	1.703 [43.3]	1.375 [34.9]	.149 [3.8]	1.438 [36.5]	1-7/16-18 UNEF	.799 [20.3]	.878 [22.3]	.965 [24.5]

D3J Jam Nut Receptacle (MS83723 / 73&74 Compatible)

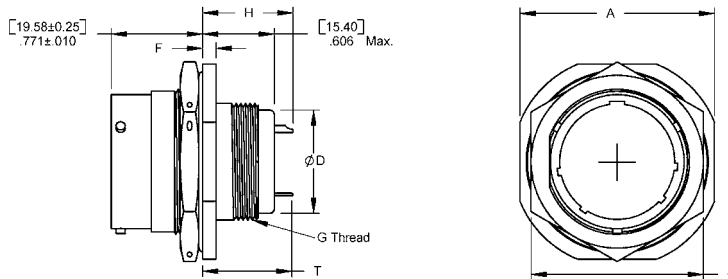

Shell Size	A Max	C Max	ϕD Max	F	G Thread	H Max		T $\pm .028$ [± 0.7]
						#22, #20, #16	#12	
8	.979 [24.9]	.829 [21.1]	.500 [12.7]	.137/.097 [3.48/2.46]	1/2-20 UNEF	.744 [18.9]	.823 [20.9]	.912 [23.2]
10	1.104 [28.0]	.954 [24.2]	.625 [15.9]	.137/.097 [3.48/2.46]	5/8-20 UNEF	.744 [18.9]	.823 [20.9]	.912 [23.2]
12	1.291 [32.8]	1.142 [29.0]	.750 [19.1]	.137/.097 [3.48/2.46]	3/4-20 UNEF	.744 [18.9]	.823 [20.9]	.912 [23.2]
14	1.391 [35.3]	1.205 [30.6]	.875 [22.2]	.137/.097 [3.48/2.46]	7/8-20 UNEF	.744 [18.9]	.823 [20.9]	.912 [23.2]
16	1.516 [38.5]	1.329 [33.8]	1.000 [25.4]	.137/.097 [3.48/2.46]	1-20 UNEF	.744 [18.9]	.823 [20.9]	.912 [23.2]
18	1.641 [41.7]	1.455 [37.0]	1.063 [27.0]	.137/.097 [3.48/2.46]	1-1/16-18 UNEF	.744 [18.9]	.823 [20.9]	.912 [23.2]
20	1.766 [44.9]	1.579 [40.1]	1.188 [30.2]	.137/.097 [3.48/2.46]	1-3/16-18 UNEF	.744 [18.9]	.823 [20.9]	.912 [23.2]
22	1.954 [49.6]	1.705 [43.3]	1.313 [33.3]	.169/.128 [4.28/3.25]	1-5/16-18 UNEF	.744 [18.9]	.823 [20.9]	.912 [23.2]
24	2.079 [52.8]	1.829 [46.5]	1.438 [36.5]	.169/.128 [4.28/3.25]	1-7/16-18 UNEF	.744 [18.9]	.823 [20.9]	.912 [23.2]

* Threaded Coupling is also available. For dimensions consult factory.
 * For panel cutout dimensions refer to pages 34-35.
 * Dimensions are in Inches. Values in brackets are Millimeters equivalents.
 * Dimensions subject to change without prior notice.

MIL-DTL-83723
 Series III
 Bayonet

D3P Plug Shell, Bayonet Coupling (MS83723 / 77&78 Compatible)

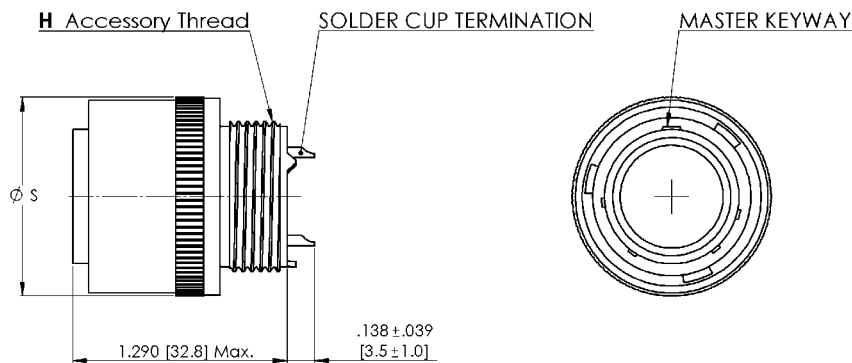

Shell Size	H Thread	S Max.
08	.5000-20 UNF	.776 [19.7]
10	.6250-24 UNEF	.906 [23.0]
12	.7500-20 UNEF	1.078 [27.4]
14	.8750-20 UNEF	1.141 [29.0]
16	1.000-20 UNEF	1.266 [32.2]
18	1.0625-18 UNEF	1.375 [34.9]
20	1.1875-18 UNEF	1.510 [38.4]
22	1.3125-18 UNEF	1.625 [41.3]
24	1.4375-18 UNEF	1.760 [44.7]

* Dimensions are in Inches. Values in brackets are Millimeters equivalents.

* Dimensions subject to change without prior notice.

Filter Electrical Characteristics per MIL-DTL-83723 contact arrangements

The following table presents the possible maximum capacitance versus working voltage per MIL-DTL-83723 contact arrangements:

MIL-DTL-83723 contact arrangements	Filter Type & Maximum Capacitance			Working Voltage [V _{DC}]	Dielectric Withstanding Voltage [V _{DC}]
	C, CL & LC	C ² & Pi (π)	Hi (2π)		
Series III					
08-03, 08-98, 10-05, 10-06, 12-12, 14-15, 16-24, 18-31, 20-28, 20-41, 22-55, 24-61	1μF	2μF	1.94μF	6.3V	15.75V
	470nF	940nF	910nF	16V	40V
	220nF	440nF	420nF	25V	62.5V
	100nF	200nF	194nF	50V	125V
	68nF	136nF	134nF	100V	250V
	33nF	66nF	63nF	200V	500V
	27nF	54nF	51nF	250V	500V
	15nF	30nF	28.6nF	300V	750V
	12nF	24nF	23.2nF	500V	750V
	8.2nF	16.4nF	16nF	600V	750V
	4.7nF	9.4nF	9.1nF	800V	960V
	2.7nF	5.4nF	5.1nF	1000V	1200V
10-02, 10-20, 12-03, 14-04, 14-07, 16-10, 18-08, 20-16, 22-12, 22-19	3μF	6μF	5.82μF	6.3V	15.75V
	1.41μF	2.82μF	2.73μF	16V	40V
	660nF	1.32μF	1.26μF	25V	62.5V
	300nF	600nF	582nF	50V	125V
	204nF	408nF	402nF	100V	250V
	99nF	198nF	189nF	200V	500V
	81nF	162nF	153nF	250V	500V
	45nF	90nF	85.8nF	300V	750V
	36nF	72nF	69.6nF	500V	750V
	24.6nF	49.2nF	48nF	600V	750V
	14.1nF	28.2nF	27.3nF	800V	960V
	8.1nF	16.2nF	15.3nF	1000V	1200V

This table can be used in two ways:

- Once a contact arrangements is selected, by using this table the capacitance and the working voltage limits can be extracted.
- Once the correct filter type and working voltage are selected, by using this table the complying contact arrangements can be determined to meet the design requirements.

Notes: Filtered connector combined with transient protection will achieve lower capacitance levels. In several contact arrangements, higher capacitance is available with or without protection. For more details contact the sales department.

Transient Protection Characteristics per MIL-DTL-83723 contact arrangements

The following table presents the possible maximum transient protection energy versus selected filter type and working voltage per MIL-DTL-83723 contact arrangements:

Max. Transient Protection Energy @ 10x1000 μ S waveform vs. Working Voltage.

MIL-DTL-83723 contact arrangements	Filter Type & Maximum Transient Protection Energy			Working Voltage [V _{DC}]	Working Voltage [V _{AC}]
	No Filter	C, CL & LC	C ² & Pi (π)		
Series III					
08-03, 08-98, 10-05, 10-06, 12-12, 14-15, 16-24, 18-31, 20-28, 20-41, 22-55, 24-61	0.9J	0.6J	0.3J	3.3V	2.3V
	0.9J	0.6J	0.3J	5.6V	4V
	0.3J	0.2J	0.1J	9V	6.4V
	0.9J	0.6J	0.3J	12V	8.5V
	0.9J	0.6J	0.3J	14V	10V
	0.9J	0.6J	0.3J	18V	13V
	0.9J	0.6J	0.3J	26V	18V
	0.3J	0.2J	0.1J	30V	21V
10-02, 10-20, 12-03, 14-04, 14-07, 16-10, 18-08, 20-16, 22-12, 22-19	2.7J	1.8J	0.9J	3.3V	2.3V
	2.7J	1.8J	0.9J	5.6V	4V
	0.9J	0.6J	0.3J	9V	6.4V
	2.7J	1.8J	0.9J	12V	8.5V
	2.7J	1.8J	0.9J	14V	10V
	2.7J	1.8J	0.9J	18V	13V
	2.7J	1.8J	0.9J	26V	18V
	0.9J	0.6J	0.3J	30V	21V

* For higher energy contact sales.

This table can be used in two ways:

- Once a contact arrangements is selected, by using this table the energy and the working voltage limits can be extracted.
- Once the correct energy and working voltage are selected, by using this table the complying filter type and contact arrangements can be determined to meet the design requirements.

Notes: Filtered connector combined with transient protection will achieve lower capacitance levels.
In several contact arrangements, higher energy is available with or without filter.
For more details contact the sales department.

Wall Mount Panel Cutout

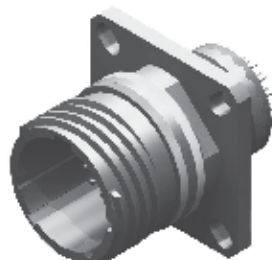
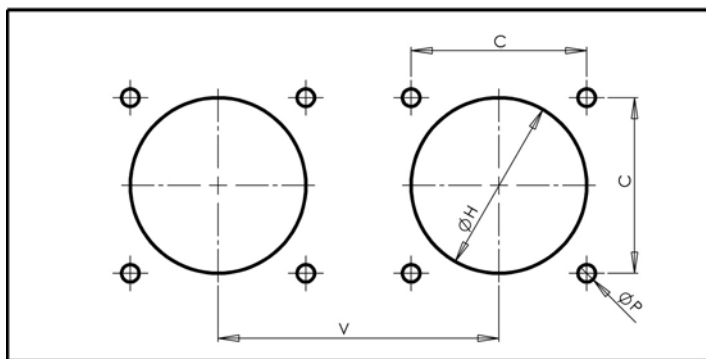

Panel Cutout Dimensions

Wall Mount MIL-DTL-38999 Series I and III

Shell Size	C ±0.13	Ø H min.		Ø P ±0.13	V min.
		Front	Rear		
09	18.26	13.11	16.66	3.25	24.60
11	20.62	15.88	20.22	3.25	27.00
13	23.01	19.05	23.42	3.25	30.20
15	24.61	23.01	26.59	3.25	33.30
17	26.97	25.81	30.96	3.25	36.50
19	29.36	28.98	32.94	3.25	39.30
21	31.75	32.16	36.12	3.25	42.50
23	34.93	34.93	39.29	3.91	45.70
25	38.10	37.69	42.47	3.91	48.80

Wall Mount MIL-DTL-26482 Series II MS3470

Shell Size	C ±0.1	Ø H +0.25	Ø P ±0.25
08	15.08	14.30	3.05
10	18.26	17.27	3.05
12	20.62	21.82	3.05
14	23.02	24.99	3.05
16	24.61	28.14	3.05
18	26.98	31.32	3.05
20	29.36	34.49	3.05
22	31.76	37.67	3.75
24	34.92	40.89	3.75

Wall Mount MIL-DTL-38999 Series II

Shell Size	C	Ø H min.		Ø P ±0.13	V min.
		Front	Rear		
08	15.09	13.11	14.15	3.25	24.60
10	18.26	15.88	17.32	3.25	27.00
12	20.62	19.05	21.69	3.25	30.20
14	23.01	23.01	24.87	3.25	33.30
16	24.61	25.81	28.04	3.25	36.50
18	26.97	28.98	31.22	3.25	39.30
20	29.36	32.16	34.39	3.25	42.50
22	31.75	34.93	37.57	3.91	45.70
24	34.93	37.69	40.74	3.91	48.80

Wall Mount MIL-DTL-83723 Series III

Shell Size	C ± 0.05	Ø H +0.1		Ø P ±0.1
		Front	Rear	
08	15.09	12.83	15.75	3.05
10	18.26	16.00	19.00	3.05
12	20.62	19.30	23.19	3.05
14	23.01	20.88	24.89	3.05
16	24.61	24.08	28.12	3.05
18	26.97	27.23	30.71	3.05
20	29.36	30.28	33.96	3.05
22	31.75	33.58	36.88	3.05
24	34.93	36.63	40.06	3.78

* The recommended dimensions are based on relevant MIL standards and published for reference only.

* Dimensions are in Millimeters.

Jam Nut Panel Cutout

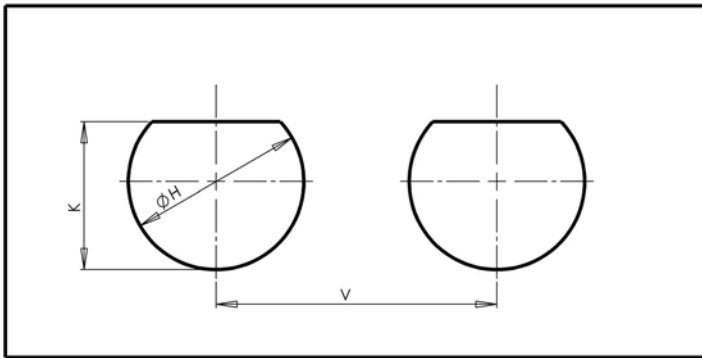

Jam Nut MIL-DTL-38999 Series I AND III

Shell Size	K -0.06	$\varnothing H$ +0.25/-0	V min.
09	16.70	17.60	27.80
11	19.59	20.96	32.60
13	24.26	25.65	36.00
15	27.56	28.83	39.60
17	30.73	32.01	43.30
19	33.91	35.18	47.00
21	37.08	38.35	50.60
23	40.26	41.53	54.20
25	43.43	44.70	59.70

Jam Nut MIL-DTL-26482 Series II

Shell Size	K ± 0.13	$\varnothing H$ ± 0.13
08	13.61	15.53
10	16.79	17.70
12	20.93	22.73
14	24.08	25.65
16	27.23	28.83
18	30.40	32.00
20	33.58	35.18
22	36.75	38.35
24	39.93	41.53

Jam Nut MIL-DTL-38999 Series II

Shell Size	K +0/-0.25	$\varnothing H$ +0.25/-0	V min.
08	21.08	22.48	27.80
10	24.26	25.65	32.60
12	27.56	28.83	36.00
14	30.73	32.01	39.60
16	33.91	35.18	43.30
18	37.08	38.35	47.00
20	40.26	41.53	50.60
22	43.42	44.70	54.20
24	46.61	47.88	59.70

Jam Nut MIL-DTL-83723 Series III

Shell Size	K ± 0.13	$\varnothing H$ ± 0.13
08	15.37	16.13
10	18.54	19.30
12	23.29	24.05
14	24.89	25.65
16	28.07	28.83
18	31.22	32.00
20	31.39	35.18
22	37.57	38.35
24	40.74	41.53

* The D-shape to be rotated 90° counterclockwise

* The recommended dimensions are based on relevant MIL standards and published for reference only.
* Dimensions are in Millimeters.

This chapter presents the codes and the electrical characteristics of filters and transient protections.

In case of homogenous working voltage, homogenous filter, homogenous transient protection or a combination of these three for all connector contacts, the code can be easily selected and expressed by the last six digits of the P/N.

A customized combination of filters and/or transient protections cannot be coded by this catalog. In such case, replace the last four digits of the P/N with XXXX. For customized P/N, use working voltage codes, filter codes and transient protection codes for each contact groups and fill into table 4 of the Check List, page 97 and contact the sales department.

Filter Type vs. Frequency Range

Use the following table for quick filter type page search:

Frequency Range	Filter Cutoff Frequency	Filter Type Page ⁽¹⁾				
		C	C ² (2)	LC & CL	π	Hi (2 π)
UHF	300MHz $\leq f \leq$ 3GHz	38	43	48	53	58
VHF	30MHz $\leq f \leq$ 300MHz	38	43	48	53	58
HF	3MHz $\leq f \leq$ 30MHz	39	44	49	54	59
MF	300kHz $\leq f \leq$ 3MHz	40	45	50	55	60
LF	30kHz $\leq f \leq$ 300kHz	41	46	51	56	61
VLF (Audio)	3kHz $\leq f \leq$ 30kHz	42	47	52	57	-

Note: For other filter topologies, e.g. Double LC, Double CL or T, contact the sales department.

- (1) Refer to the Design Notes (page 92) for explanation regarding the differences between filter topologies and for equivalent circuits.
- (2) Both C and C² type Filters have a C type filter topology. The C² type filter provides higher attenuation.
- (3) CL filters are symmetrical to LC filters. Refer to the illustrated description on page 92 for details related to the differences between the two.

Content of Section

Section	Page
General and Codes	37
C Filter	38-42
C ² Filter	43-47
LC & CL Filter	48-52
π Filter	53-57
Hi Filter (double π)	58-61
Introduction to Bidirectional Varistor	62
Transient Protection Codes	63
C Filter Combined with Bidirectional Transient Protection	64
C ² Filter Combined with Bidirectional Transient Protection	65
LC Filter Combined with Bidirectional Transient Protection	66
CL Filter Combined with Bidirectional Transient Protection	67
π Filter Combined with Bidirectional Transient Protection	68

General Electrical Characteristics

Contact Size	22	20	16	12	8
Current Rating	5A	7.5A	13A	23A	35A
Insulation Resistance	5GΩ or 50ΩF (Whichever is less)				

Working Voltage Codes

The working voltage of filter components is expressed by two digits in the P/N (refer to connector family HTO page). Use the following tables for selecting the working voltage code.

Homogenous Working Voltage [V _{DC}]																
DWV	2.5 X WV						1.5 X WV (min. 500V _{DC})					1.2 X WV (min. 750VDC)				
WV	6.3	10	16	25	50	100	200	250	300	400	500	600	800	1k	1.5k	2k
Code	01	02	03	04	05	06	07	08	09	10	11	12	14	15	16	17

Mixed Working Voltage		Transient Protection	
Code	00	99	

Note: The transient protection limits the working voltage of the filter. Refer to the Filter Electrical Characteristics vs. Contact Arrangements section on pages 14, 23 and 32 and Transient Protection vs. Contact Arrangement on page 15, 24 and 33.

Filter and Transient Protection Codes

The filter code and/or transient protection code are expressed by the last four letters and digits of the P/N. The following sections present the electrical characteristics and codes of:

- a. Six filter types (C, C², LC, CL, Pi and Hi). The codes are shown on pages 38-61 along filter types, capacitance and attenuation curves.
- b. Four transient protection types and their codes (0.1J, 0.2J, 0.3J and 0.6J). The codes are shown on page 63 along transient protection energy level.
- c. Suggested combinations of filter types with transient protection types and their codes. The codes are shown on pages 64-68. Other options also available.

For explanations regarding the selection of the most suitable filter and transient protection refer to the Design Notes (page 84).

Note: The codes are applicable only when the same filter type, transient protection type or combination of these is used for all of connector contacts.

For more details contact the sales department.

C Filter

Audio	LF	MF	HF	VHF	UHF
$f \leq 30\text{kHz}$	$30\text{kHz} \leq f \leq 300\text{kHz}$	$300\text{kHz} \leq f \leq 3\text{MHz}$	$3\text{MHz} \leq f \leq 30\text{MHz}$	$30\text{MHz} \leq f \leq 300\text{MHz}$	$300\text{MHz} \leq f \leq 3\text{GHz}$

Typical cutoff frequency (-3dB) $f_{co} \geq 30\text{MHz}$.

Minimum Attenuation

Filter Code	Typical Cap. [pF] (2)	f_{co} [MHz] Typical (3)	Min. Attenuation [dB] VS. Frequency [MHz] (1)								
			1	5	10	30	50	100	300	500	1000
CC08	47	92	0	0	0	0	0	1	24	37	40
CC10	82	63.5	0	0	0	0	0	4	29	49	33
CC18	120	52.7	0	0	0	0	0	7	33	59	31
CC23	180	38.5	0	0	0	0	2	12	42	48	31

(1) Measured in 50Ω system according to MIL-STD -220, no load.

(2) Capacitance tolerance: ±20%. For other capacitance values, contact technical support.

(3) For estimation of the filter cut off frequency in non-50Ω system please refer to the design notes.

Typical measured filter attenuation

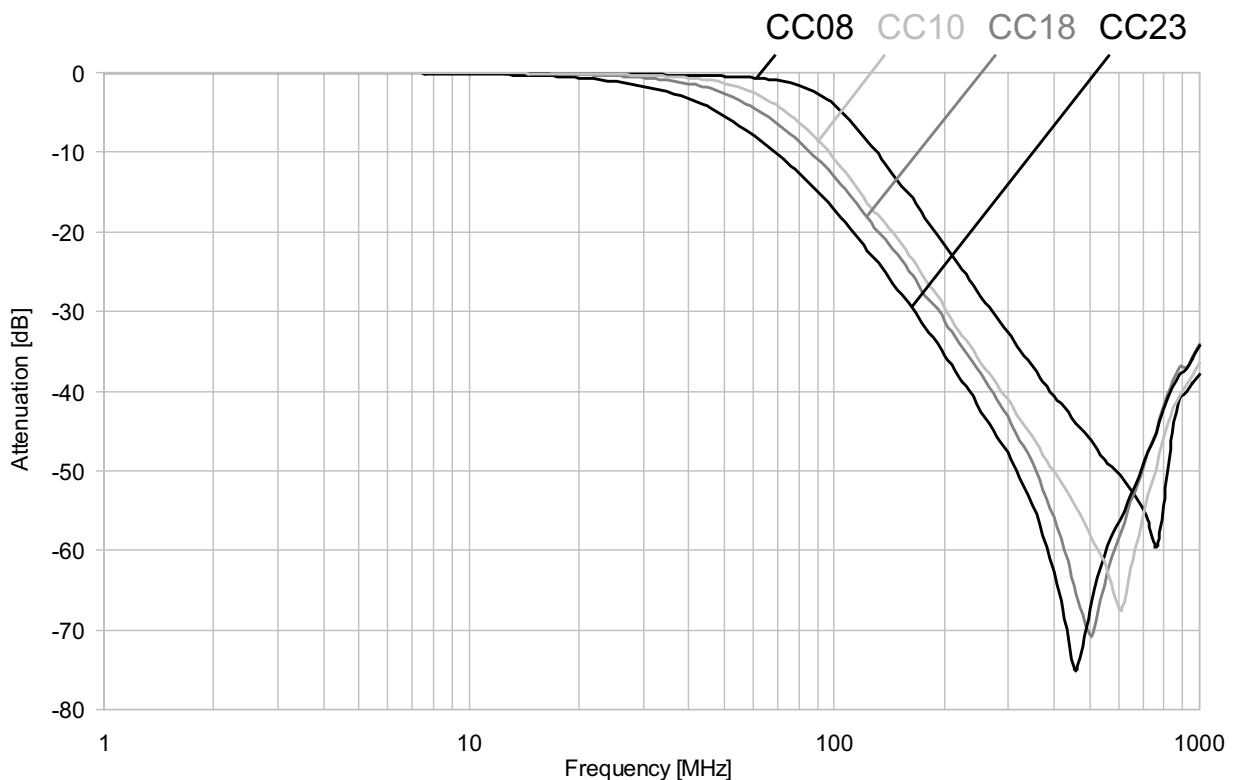

Note: All filters characteristics subject to change without prior notice.

C Filter

Audio	LF	MF	HF	VHF	UHF
$f \leq 30\text{kHz}$	$30\text{kHz} \leq f \leq 300\text{kHz}$	$300\text{kHz} \leq f \leq 3\text{MHz}$	$3\text{MHz} \leq f \leq 30\text{MHz}$	$30\text{MHz} \leq f \leq 300\text{MHz}$	$300\text{MHz} \leq f \leq 3\text{GHz}$

Typical cutoff frequency (-3dB) $f_{co} \geq 3\text{MHz}$.

Minimum Attenuation

Filter Code	Typical Cap. [pF] (2)	f_{co} [MHz] Typical (3)	Min. Attenuation [dB] VS. Frequency [MHz] (1)								
			1	5	10	30	50	100	300	500	1000
CC30	220	31.6	0	0	0	1	5	14	44	46	31
CC33	330	21	0	0	0	3	9	18	49	44	31
CC36	470	16	0	0	0	5	11	19	49	45	28
CC39	1000	7.6	0	0	2	10	16	27	39	38	26
CC40	1500	5	0	1	4	14	21	35	41	42	31
CC42	2200	3.2	0	2	6	17	23	35	39	39	28

- (1) Measured in 50Ω system according to MIL-STD -220, no load.
- (2) Capacitance tolerance: ±20%. For other capacitance values, contact technical support.
- (3) For estimation of the filter cut off frequency in non-50Ω system please refer to the design notes.

Typical measured filter attenuation

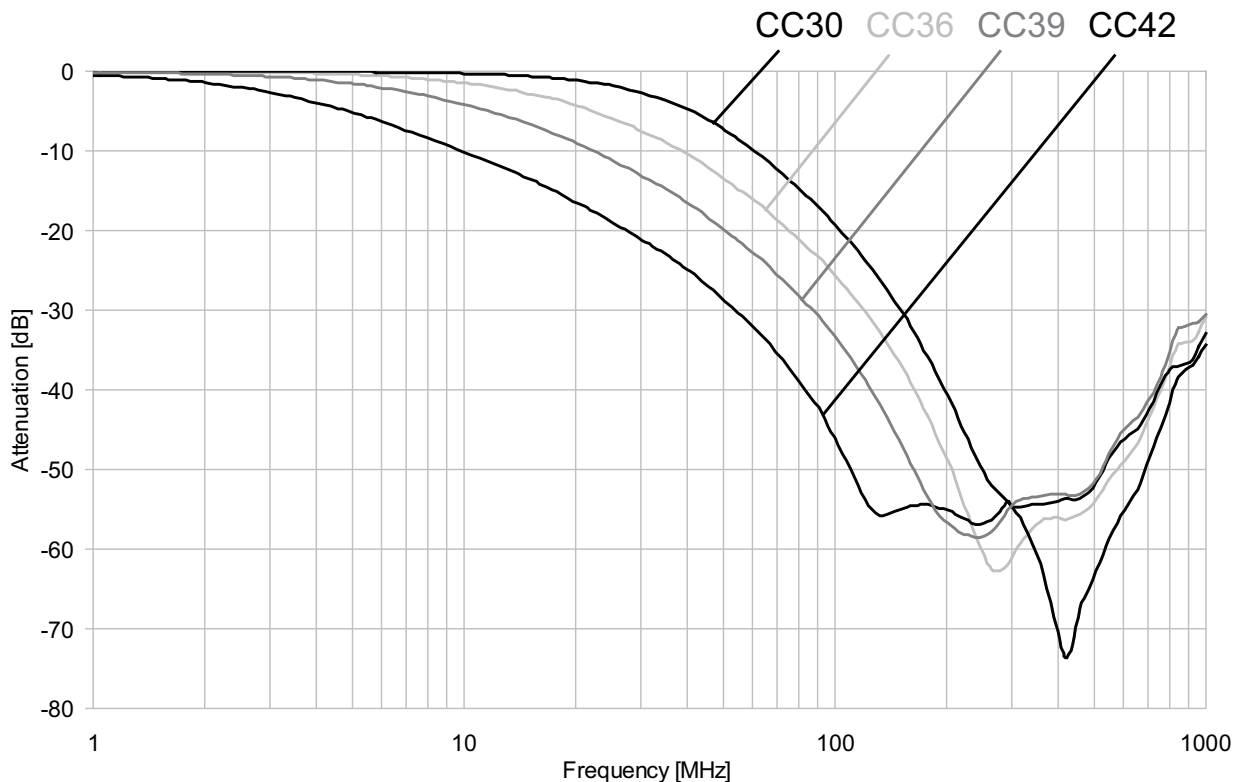

Note: All filters characteristics subject to change without prior notice.

C Filter

Audio	LF	MF	HF	VHF	UHF
$f \leq 30\text{kHz}$	$30\text{kHz} \leq f \leq 300\text{kHz}$	$300\text{kHz} \leq f \leq 3\text{MHz}$	$3\text{MHz} \leq f \leq 30\text{MHz}$	$30\text{MHz} \leq f \leq 300\text{MHz}$	$300\text{MHz} \leq f \leq 3\text{GHz}$

Typical cutoff frequency (-3dB) $f_{co} \geq 300\text{kHz}$.

Minimum Attenuation

Filter Code	Typical Cap. [nF] (2)	f_{co} [MHz] Typical (3)	Min. Attenuation [dB] VS. Frequency [MHz] (1)								
			1	5	10	30	50	100	300	500	1000
CC54	4.7	2.3	0	5	10	21	27	35	42	43	29
CC58	6.8	0.92	2	11	17	29	38	43	39	41	31
CC62	10	0.695	3	14	20	32	44	40	40	41	29
CC66	15	0.420	4	17	23	37	49	37	38	39	29

(1) Measured in 50Ω system according to MIL-STD -220, no load.

(2) Capacitance tolerance: ±20%. For other capacitance values, contact technical support.

(3) For estimation of the filter cut off frequency in non-50Ω system please refer to the design notes.

Typical measured filter attenuation

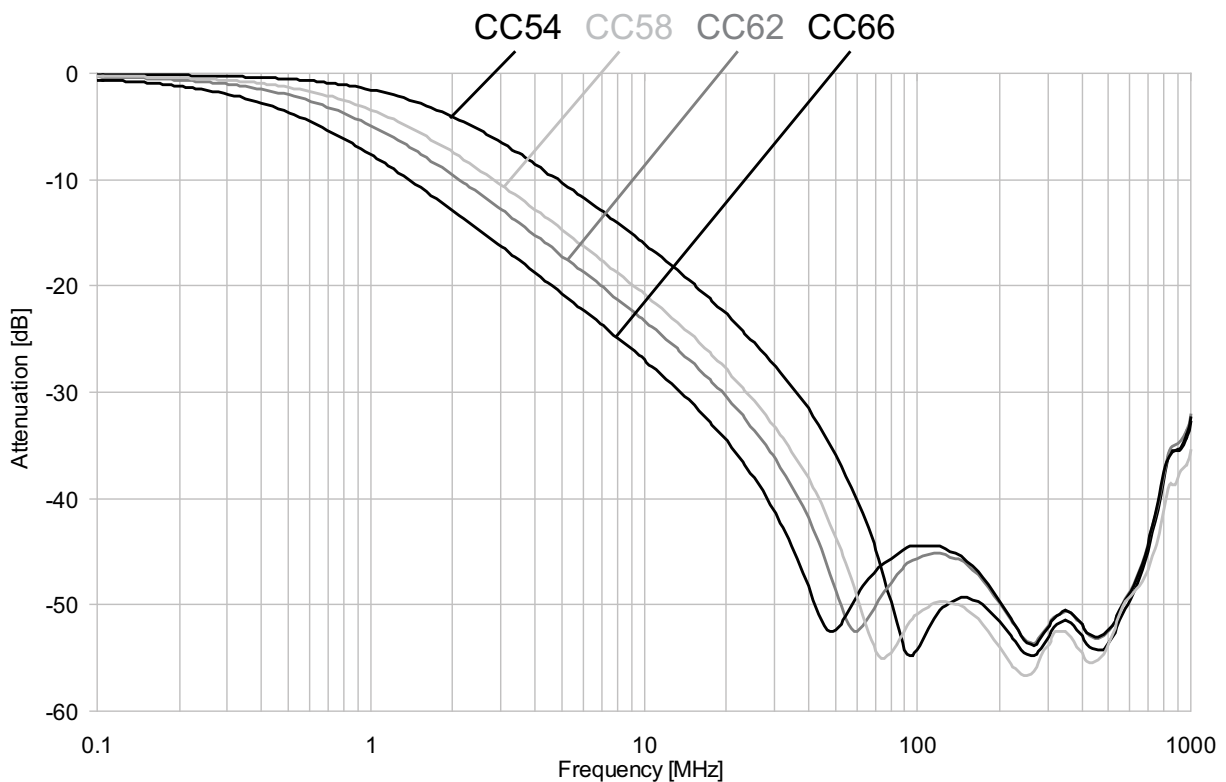

Note: All filters characteristics subject to change without prior notice.

C Filter

Audio	LF	MF	HF	VHF	UHF
$f \leq 30\text{kHz}$	$30\text{kHz} \leq f \leq 300\text{kHz}$	$300\text{kHz} \leq f \leq 3\text{MHz}$	$3\text{MHz} \leq f \leq 30\text{MHz}$	$30\text{MHz} \leq f \leq 300\text{MHz}$	$300\text{MHz} \leq f \leq 3\text{GHz}$

Typical cutoff frequency (-3dB) $f_{co} \geq 30\text{kHz}$.

Minimum Attenuation

Filter Code	Typical Cap. [nF] (2)	f_{co} [kHz] Typical (3)	Min. Attenuation [dB] VS. Frequency [MHz] (1)								
			1	5	10	30	50	100	300	500	1000
CC70	22	251	8	22	27	31	32	33	39	41	31
CC72	33	182	11	24	31	51	44	38	41	42	31
CC74	47	109	16	30	36	43	41	37	39	41	30
CC76	100	63	22	36	43	46	41	38	40	42	31
CC78	220	30	27	42	53	41	38	33	35	36	31

- (1) Measured in 50Ω system according to MIL-STD -220, no load.
- (2) Capacitance tolerance: ±20%. For other capacitance values, contact technical support.
- (3) For estimation of the filter cut off frequency in non-50Ω system please refer to the design notes.

Typical measured filter attenuation

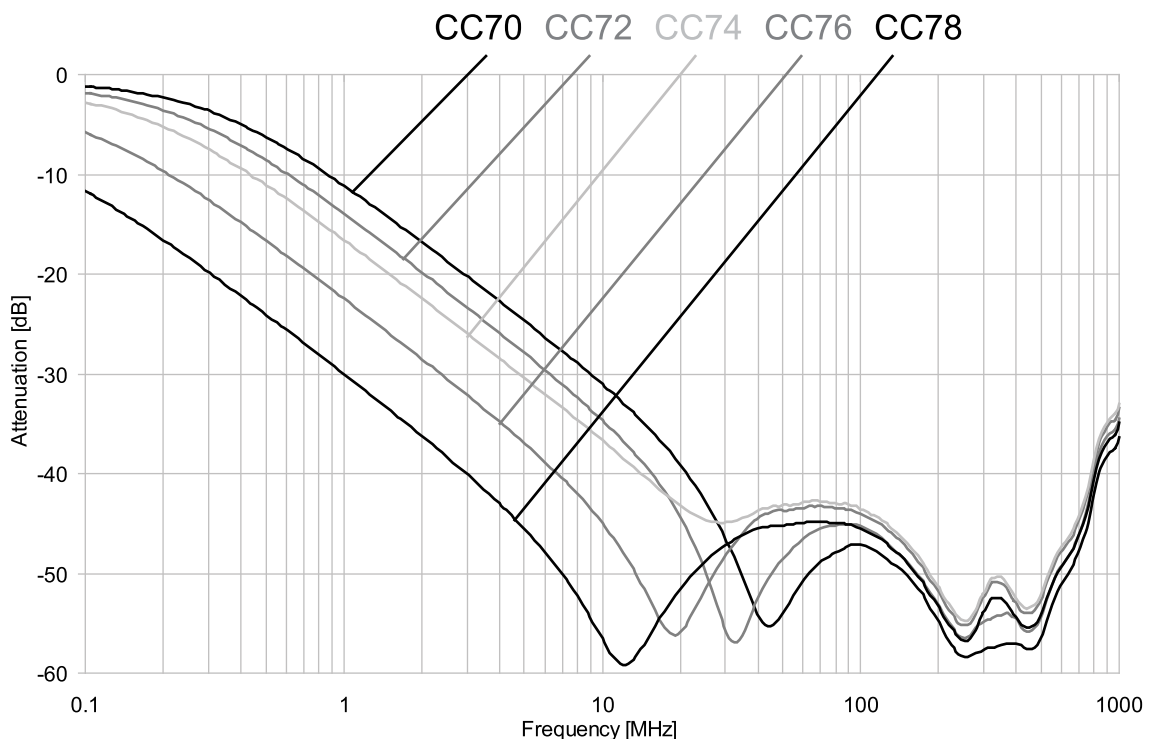

Note: All filters characteristics subject to change without prior notice.

C Filter

Audio	LF	MF	HF	VHF	UHF
$f \leq 30\text{kHz}$	$30\text{kHz} \leq f \leq 300\text{kHz}$	$300\text{kHz} \leq f \leq 3\text{MHz}$	$3\text{MHz} \leq f \leq 30\text{MHz}$	$30\text{MHz} \leq f \leq 300\text{MHz}$	$300\text{MHz} \leq f \leq 3\text{GHz}$

Typical cutoff frequency (-3dB) $f_{co} \leq 30\text{kHz}$.

Minimum Attenuation

Filter Code	Typical Cap. [μF] (2)	f_{co} [kHz] Typical (3)	Min. Attenuation [dB] VS. Frequency [MHz] (1)								
			1	5	10	30	50	100	300	500	1000
CC84	0.47	12.4	35	54	53	40	37	32	33	33	27
CC86	1	6.2	40	59	47	37	34	29	30	30	27
CC92	10	0.67	61	54	48	40	36	32	33	33	27

- (1) Measured in 50 Ω system according to MIL-STD -220, no load.
- (2) Capacitance tolerance: $\pm 20\%$. For other capacitance values, contact sales.
- (3) For estimation of the filter cut off frequency in non-50 Ω system please refer to the design notes.

Typical measured filter attenuation

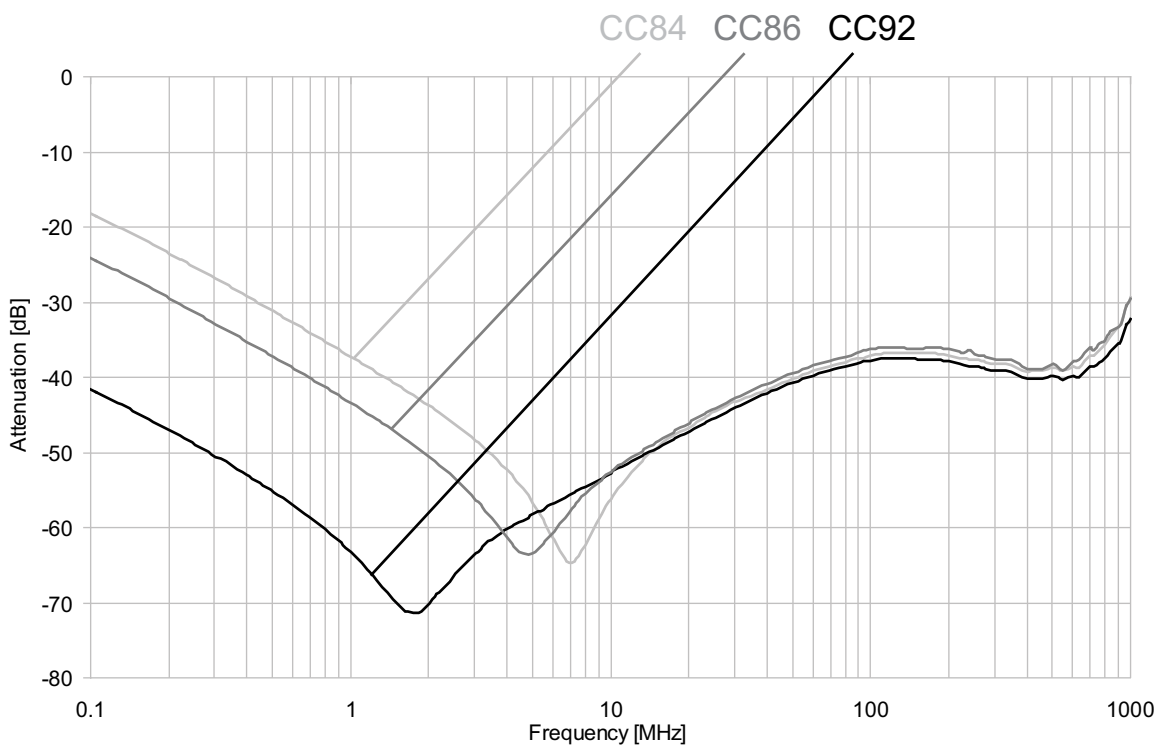

Note: All filters characteristics subject to change without prior notice.

C² Filter

Audio	LF	MF	HF	VHF	UHF
$f \leq 30\text{kHz}$	$30\text{kHz} \leq f \leq 300\text{kHz}$	$300\text{kHz} \leq f \leq 3\text{MHz}$	$3\text{MHz} \leq f \leq 30\text{MHz}$	$30\text{MHz} \leq f \leq 300\text{MHz}$	$300\text{MHz} \leq f \leq 3\text{GHz}$

Typical cutoff frequency (-3dB) $f_{\infty} \geq 30\text{MHz}$.

Minimum Attenuation

Filter Code	Typical Cap. [pF] (2)	f_{∞} [MHz] Typical (3)	Min. Attenuation [dB] VS. Frequency [MHz] (1)								
			1	5	10	30	50	100	300	500	1000
CS10	94	63.5	0	0	0	0	0	6	27	20	59
CS15	164	41.6	0	0	0	0	3	11	29	62	48

- (1) Measured in 50Ω system according to MIL-STD -220, no load.
- (2) Capacitance tolerance: ±20%. For other capacitance values, contact technical support.
- (3) For estimation of the filter cut off frequency in non-50Ω system please refer to the design notes.

Typical measured filter attenuation

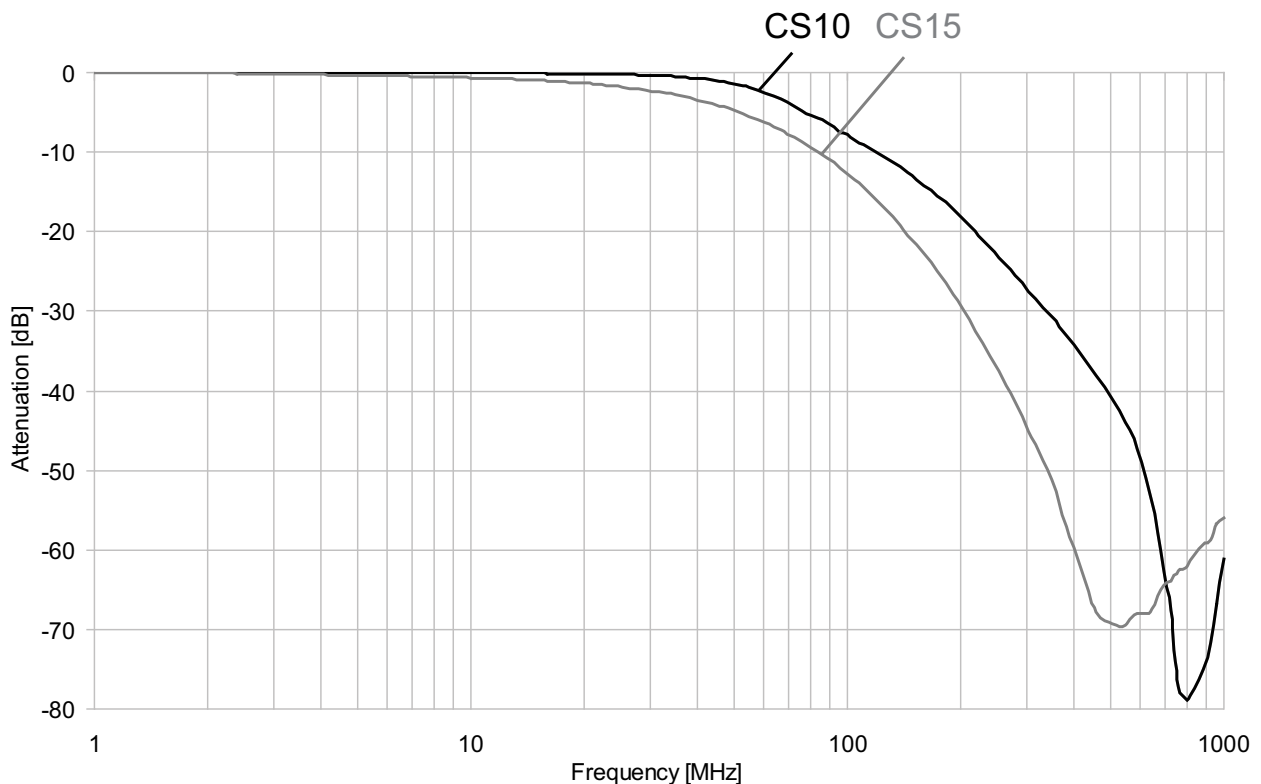

* Note: All filters characteristics subject to change without prior notice.

C² Filter

Audio	LF	MF	HF	VHF	UHF
$f \leq 30\text{kHz}$	$30\text{kHz} \leq f \leq 300\text{kHz}$	$300\text{kHz} \leq f \leq 3\text{MHz}$	$3\text{MHz} \leq f \leq 30\text{MHz}$	$30\text{MHz} \leq f \leq 300\text{MHz}$	$300\text{MHz} \leq f \leq 3\text{GHz}$

Typical cutoff frequency (-3dB) $f_{co} \geq 3\text{MHz}$.

Minimum Attenuation

Filter Code	Typical Cap. [pF] (2)	f_{co} [MHz] Typical (3)	Min. Attenuation [dB] VS. Frequency [MHz] (1)								
			1	5	10	30	50	100	300	500	1000
CS24	240	29	0	0	0	1	5	14	30	75	44
CS28	440	16	0	0	0	5	11	20	43	65	44
CS32	940	7.6	0	0	3	10	15	22	61	62	39
CS36	2000	3.7	0	3	6	16	22	29	55	53	40

(1) Measured in 50Ω system according to MIL-STD -220, no load.

(2) Capacitance tolerance: ±20%. For other capacitance values, contact technical support.

(3) For estimation of the filter cut off frequency in non-50Ω system please refer to the design notes.

Typical measured filter attenuation

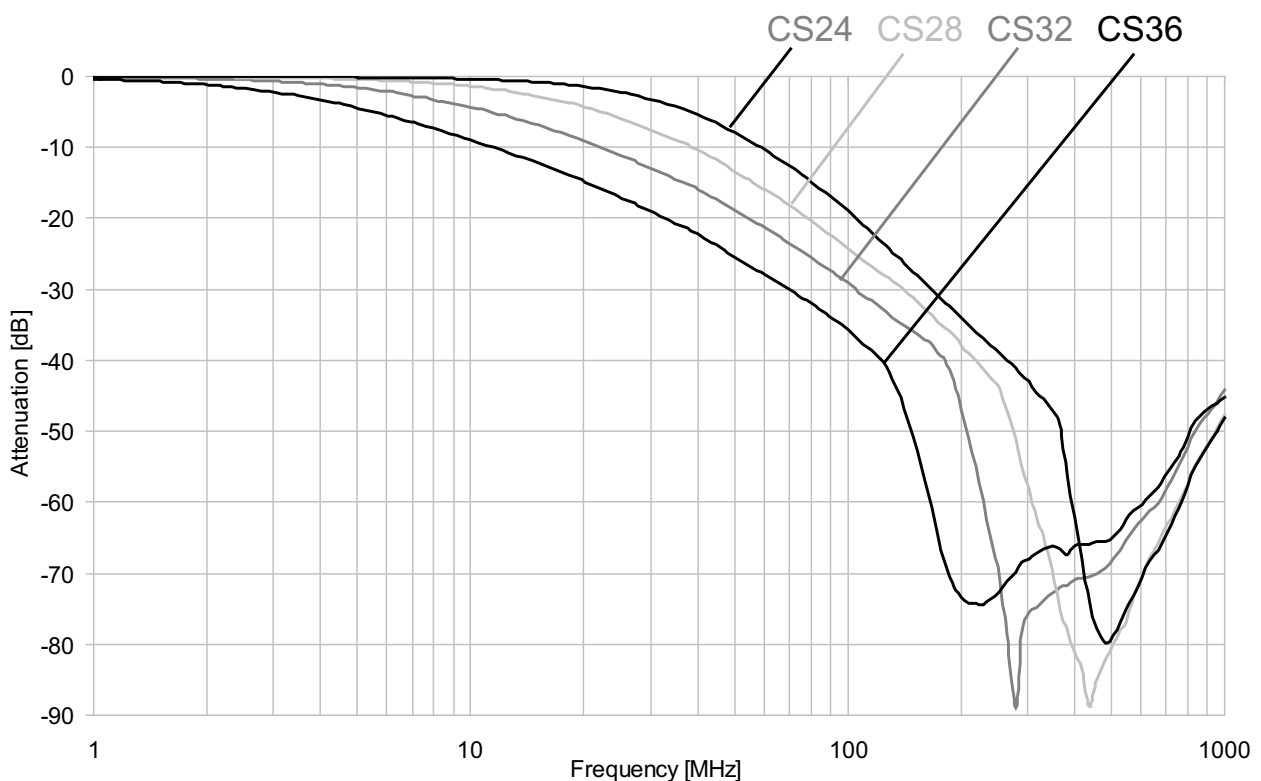

* Note: All filters characteristics subject to change without prior notice.

C² Filter

Audio	LF	MF	HF	VHF	UHF
$f \leq 30\text{kHz}$	$30\text{kHz} \leq f \leq 300\text{kHz}$	$300\text{kHz} \leq f \leq 3\text{MHz}$	$3\text{MHz} \leq f \leq 30\text{MHz}$	$30\text{MHz} \leq f \leq 300\text{MHz}$	$300\text{MHz} \leq f \leq 3\text{GHz}$

Typical cutoff frequency (-3dB) $f_{\infty} \geq 300\text{kHz}$.

Minimum Attenuation

Filter Code	Typical Cap. [nF] (2)	f_{∞} [MHz] Typical (3)	Min. Attenuation [dB] VS. Frequency [MHz] (1)								
			1	5	10	30	50	100	300	500	1000
CS43	3	2.3	0	5	10	21	26	34	56	55	41
CS46	4.4	1.74	0	8	13	24	27	41	56	50	43
CS49	9.4	0.677	2	14	20	28	30	65	53	52	41
CS52	13.6	0.47	5	18	24	33	38	58	54	56	46
CS55	20	0.325	7	21	27	33	54	54	56	58	41

- (1) Measured in 50Ω system according to MIL-STD -220, no load.
- (2) Capacitance tolerance: ±20%. For other capacitance values, contact technical support.
- (3) For estimation of the filter cut off frequency in non-50Ω system please refer to the design notes.

Typical measured filter attenuation

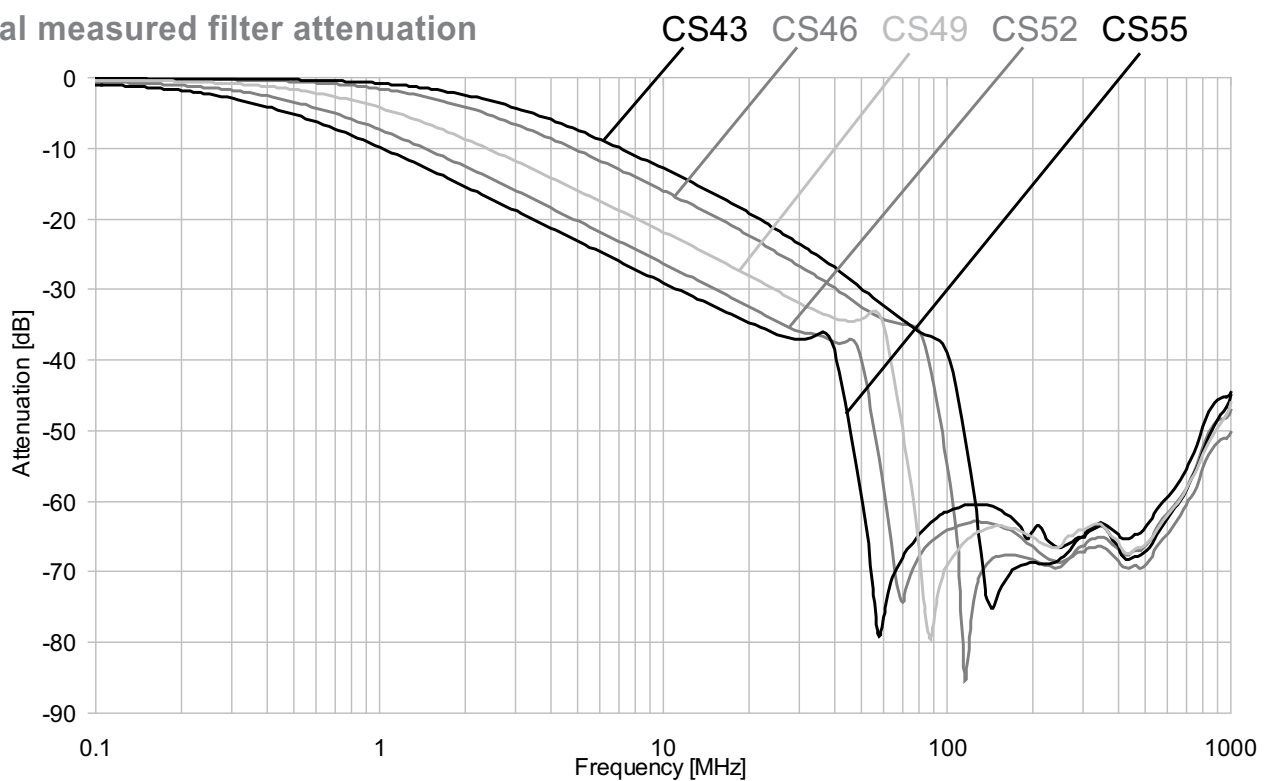

* Note: All filters characteristics subject to change without prior notice.

C² Filter

Audio	LF	MF	HF	VHF	UHF
$f \leq 30\text{kHz}$	$30\text{kHz} \leq f \leq 300\text{kHz}$	$300\text{kHz} \leq f \leq 3\text{MHz}$	$3\text{MHz} \leq f \leq 30\text{MHz}$	$30\text{MHz} \leq f \leq 300\text{MHz}$	$300\text{MHz} \leq f \leq 3\text{GHz}$

Typical cutoff frequency (-3dB) $f_{co} \geq 30\text{kHz}$.

Minimum Attenuation

Filter Code	Typical Cap. [nF] (2)	f_{co} [kHz] Typical (3)	Min. Attenuation [dB] VS. Frequency [MHz] (1)								
			1	5	10	30	50	100	300	500	1000
CS62	24	167	9	22	27	35	56	55	55	57	46
CS65	44	105	14	27	31	38	40	44	53	55	47
CS68	66	99	17	31	36	52	54	50	52	54	44
CS71	94	67.7	20	32	37	50	50	48	52	53	42

(1) Measured in 50Ω system according to MIL-STD -220, no load.

(2) Capacitance tolerance: ±20%. For other capacitance values, contact technical support.

(3) For estimation of the filter cut off frequency in non-50Ω system please refer to the design notes.

Typical measured filter attenuation

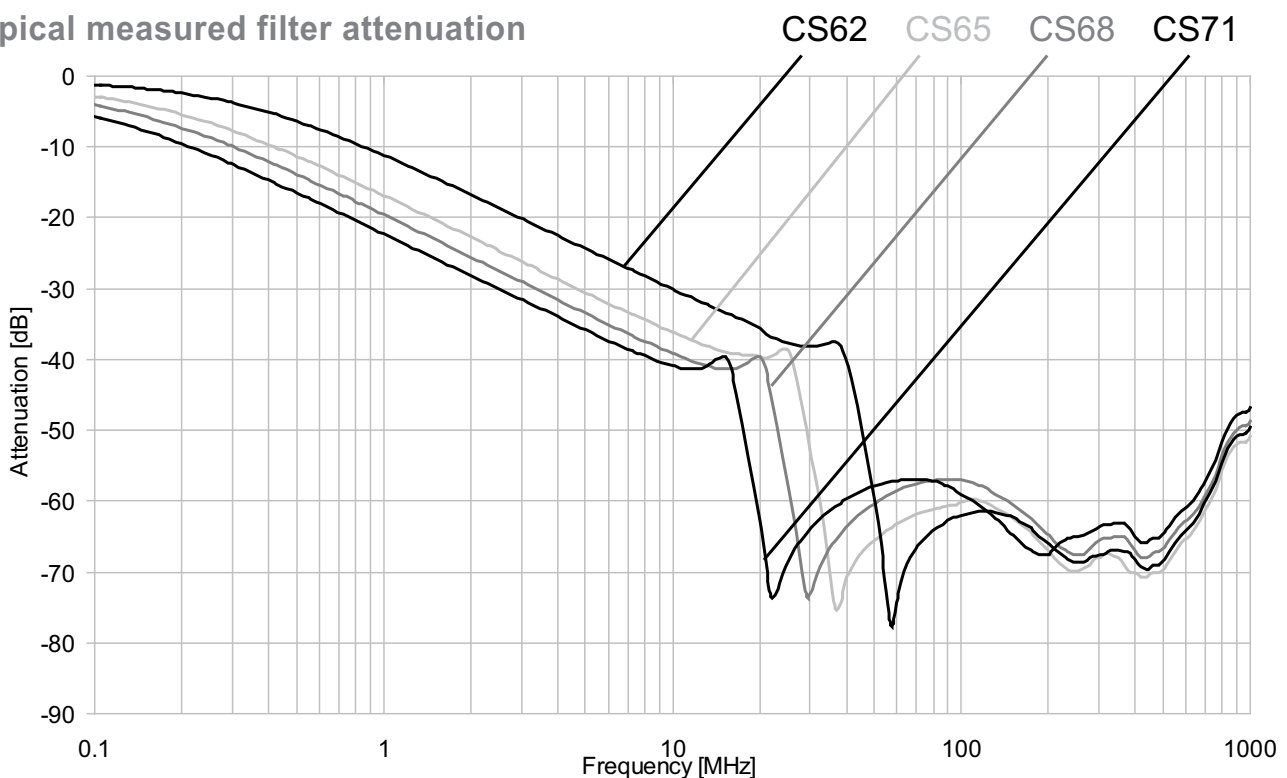

* Note: All filters characteristics subject to change without prior notice.

C² Filter

Audio	LF	MF	HF	VHF	UHF
$f \leq 30\text{kHz}$	$30\text{kHz} \leq f \leq 300\text{kHz}$	$300\text{kHz} \leq f \leq 3\text{MHz}$	$3\text{MHz} \leq f \leq 30\text{MHz}$	$30\text{MHz} \leq f \leq 300\text{MHz}$	$300\text{MHz} \leq f \leq 3\text{GHz}$

Typical cutoff frequency (-3dB) $f_{\infty} \leq 30\text{kHz}$.

Minimum Attenuation

Filter Code	Typical Cap. [μF] (2)	f_{∞} [kHz] Typical (3)	Min. Attenuation [dB] VS. Frequency [MHz] (1)								
			1	5	10	30	50	100	300	500	1000
CS80	0.44	12	33	45	63	51	47	44	47	45	47
CS88	0.94	6.5	40	54	61	50	47	42	44	44	44
CS91	2	3.1	46	72	60	52	49	46	47	47	48
CS96	20	0.35	62	65	59	51	48	43	44	45	45

- (1) Measured in 50 Ω system according to MIL-STD -220, no load.
- (2) Capacitance tolerance: $\pm 20\%$. For other capacitance values, contact technical support.
- (3) For estimation of the filter cut off frequency in non-50 Ω system please refer to the design notes.

Typical measured filter attenuation

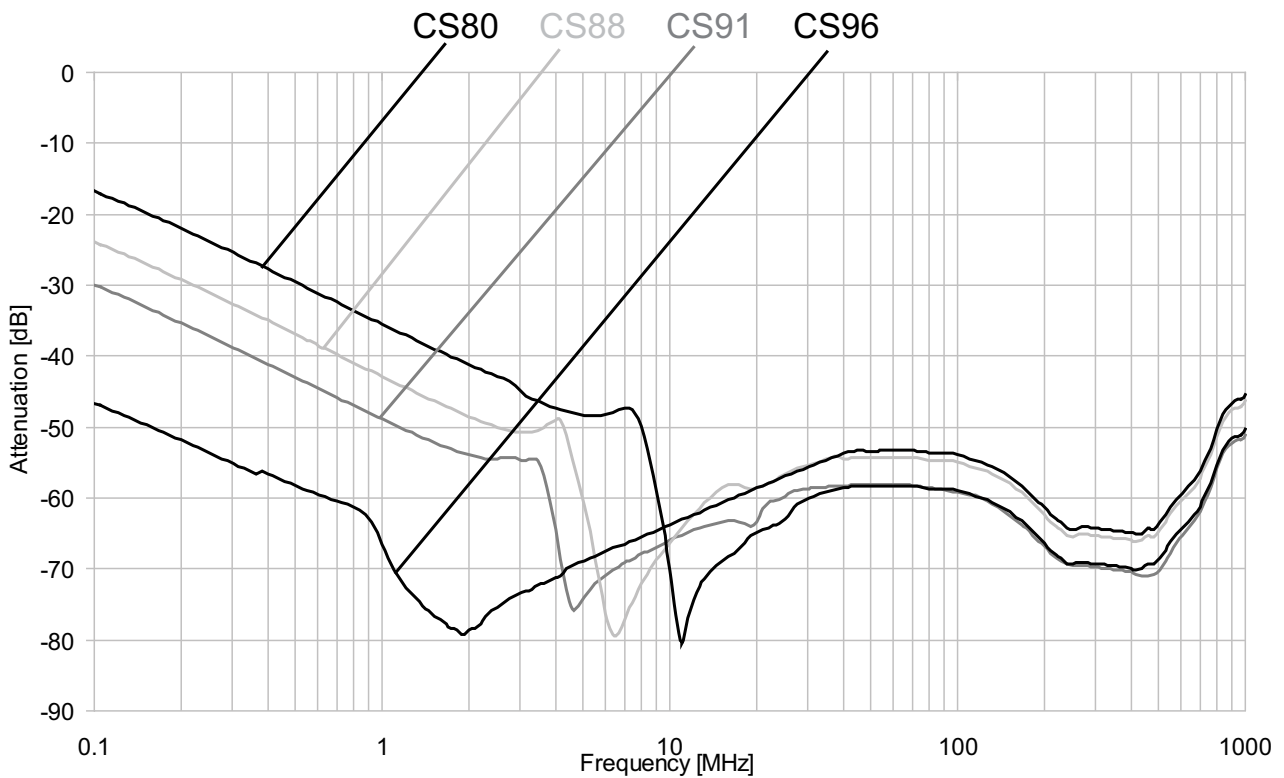

* Note: All filters characteristics subject to change without prior notice.

LC&CL Filter

Audio	LF	MF	HF	VHF	UHF
$f \leq 30\text{kHz}$	$30\text{kHz} \leq f \leq 300\text{kHz}$	$300\text{kHz} \leq f \leq 3\text{MHz}$	$3\text{MHz} \leq f \leq 30\text{MHz}$	$30\text{MHz} \leq f \leq 300\text{MHz}$	$300\text{MHz} \leq f \leq 3\text{GHz}$

Typical cutoff frequency (-3dB) $f_{co} \geq 30\text{MHz}$.

Minimum Attenuation

Filter Code (*)	Typical Cap. [pF] (2)	f_{co} [MHz] Typical (3)	Min. Attenuation [dB] VS. Frequency [MHz] (1)								
			1	5	10	30	50	100	300	500	1000
LC10	82	54.3	0	0	0	0	0	2	24	42	31
LC15	120	42.5	0	0	0	0	2	5	29	45	31

(*) For CL filter replace LC with CL

(1) Measured in 50Ω system according to MIL-STD -220, no load.

(2) Capacitance tolerance: ±20%. For other capacitance values, contact sales.

(3) For estimation of the filter cut off frequency in non-50Ω system please refer to the design notes.

Typical measured filter attenuation

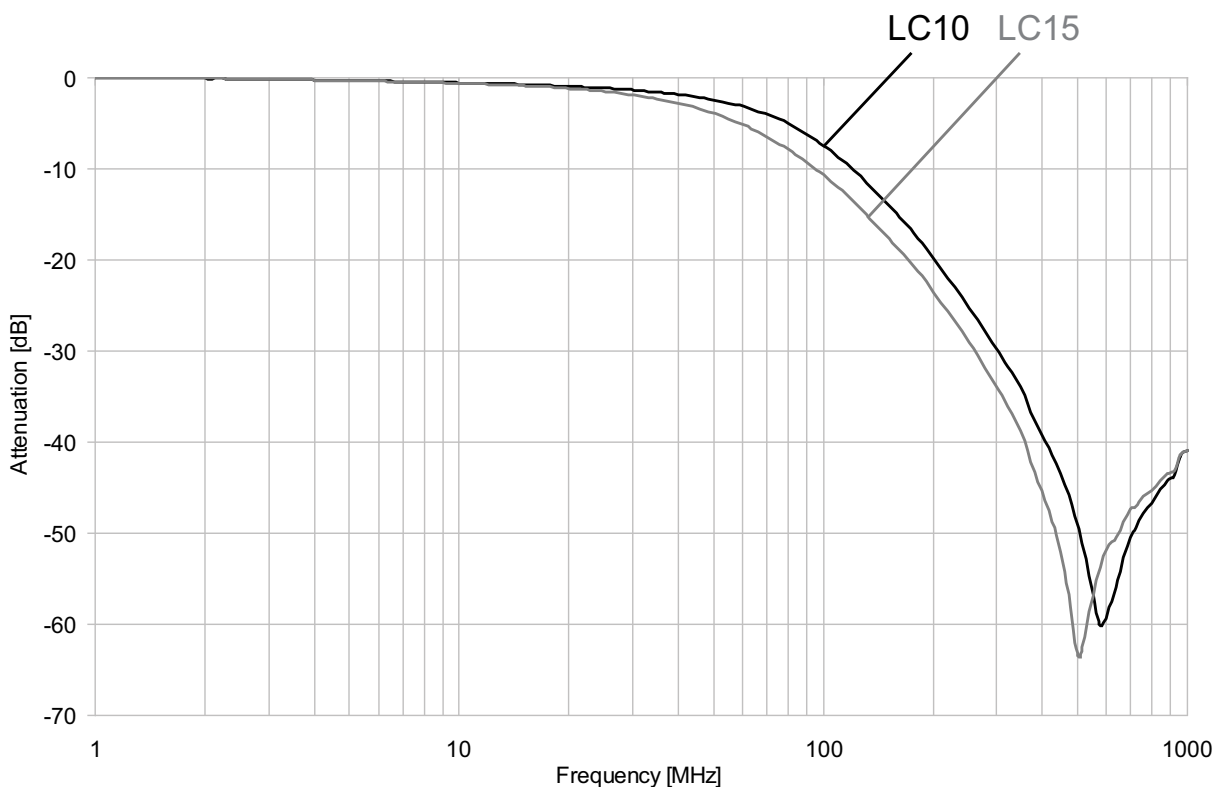

* Note: All filters characteristics subject to change without prior notice.

LC&CL Filter

Audio	LF	MF	HF	VHF	UHF
$f \leq 30\text{kHz}$	$30\text{kHz} \leq f \leq 300\text{kHz}$	$300\text{kHz} \leq f \leq 3\text{MHz}$	$3\text{MHz} \leq f \leq 30\text{MHz}$	$30\text{MHz} \leq f \leq 300\text{MHz}$	$300\text{MHz} \leq f \leq 3\text{GHz}$

Typical cutoff frequency (-3dB) $f_{co} \geq 3\text{MHz}$.

Minimum Attenuation

Filter Code (*)	Typical Cap. [pF] (2)	f_{co} [MHz] Typical (3)	Min. Attenuation [dB] VS. Frequency [MHz] (1)								
			1	5	10	30	50	100	300	500	1000
LC24	220	23.3	0	0	0	2	5	12	40	42	33
LC28	470	12.6	0	0	0	4	8	14	38	40	31
LC32	1000	6.85	0	0	2	11	17	25	36	35	28
LC36	1800	3.7	0	3	6	17	23	33	37	34	31

(*) For CL filter replace LC with CL

- (1) Measured in 50Ω system according to MIL-STD -220, no load.
- (2) Capacitance tolerance: ±20%. For other capacitance values, contact sales.
- (3) For estimation of the filter cut off frequency in non-50Ω system please refer to the design notes.

Typical measured filter attenuation

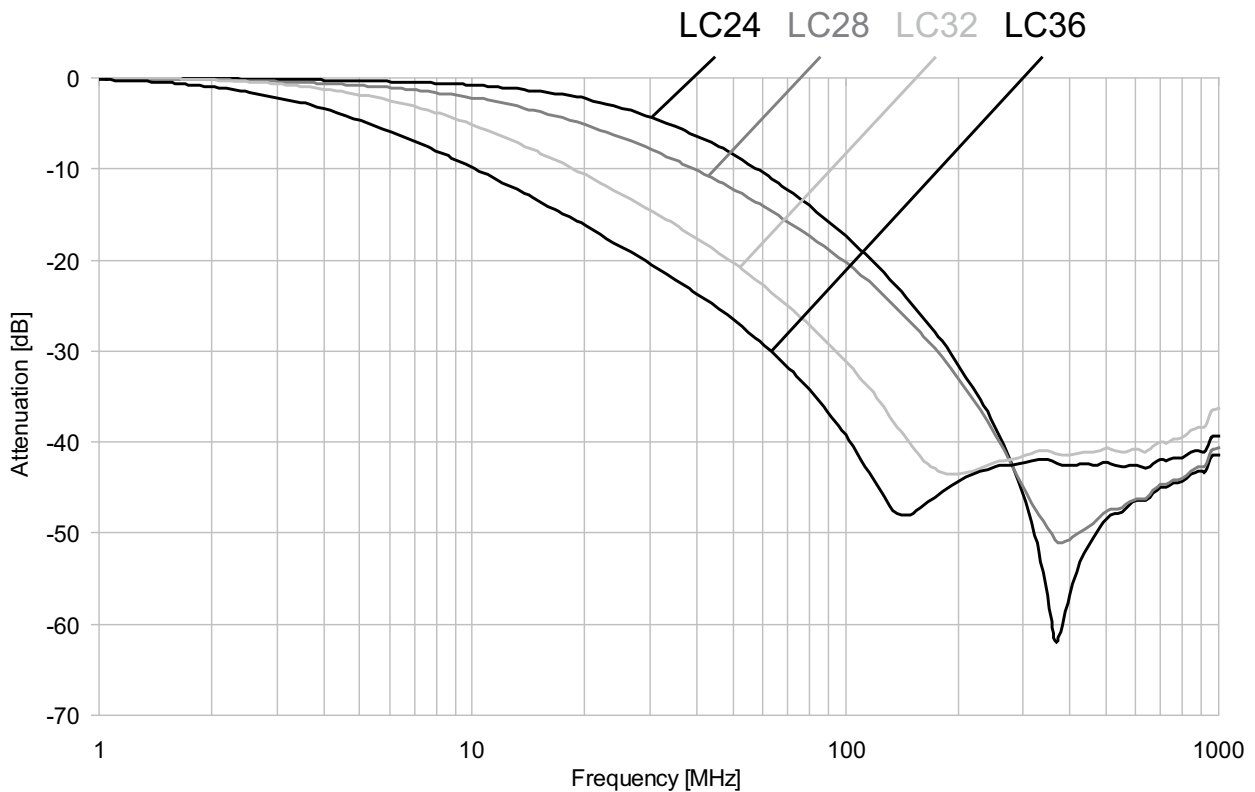

* Note: All filters characteristics subject to change without prior notice.

LC&CL Filter

Audio	LF	MF	HF	VHF	UHF
$f \leq 30\text{kHz}$	$30\text{kHz} \leq f \leq 300\text{kHz}$	$300\text{kHz} \leq f \leq 3\text{MHz}$	$3\text{MHz} \leq f \leq 30\text{MHz}$	$30\text{MHz} \leq f \leq 300\text{MHz}$	$300\text{MHz} \leq f \leq 3\text{GHz}$

Typical cutoff frequency (-3dB) $f_{co} \geq 300\text{kHz}$.

Minimum Attenuation

Filter Code (*)	Typical Cap. [nF] (2)	f_{co} [MHz] Typical (3)	Min. Attenuation [dB] VS. Frequency [MHz] (1)								
			1	5	10	30	50	100	300	500	1000
LC43	4.7	1.4	0	8	13	24	31	44	37	38	31
LC46	6.8	0.975	1	12	17	30	39	41	37	38	31
LC49	10	0.690	3	15	21	34	44	38	36	38	30
LC52	15	0.46	5	18	24	39	50	36	35	36	31

(*) For CL filter replace LC with CL

(1) Measured in 50Ω system according to MIL-STD -220, no load.

(2) Capacitance tolerance: ±20%. For other capacitance values, contact sales.

(3) For estimation of the filter cut off frequency in non-50Ω system please refer to the design notes.

Typical measured filter attenuation

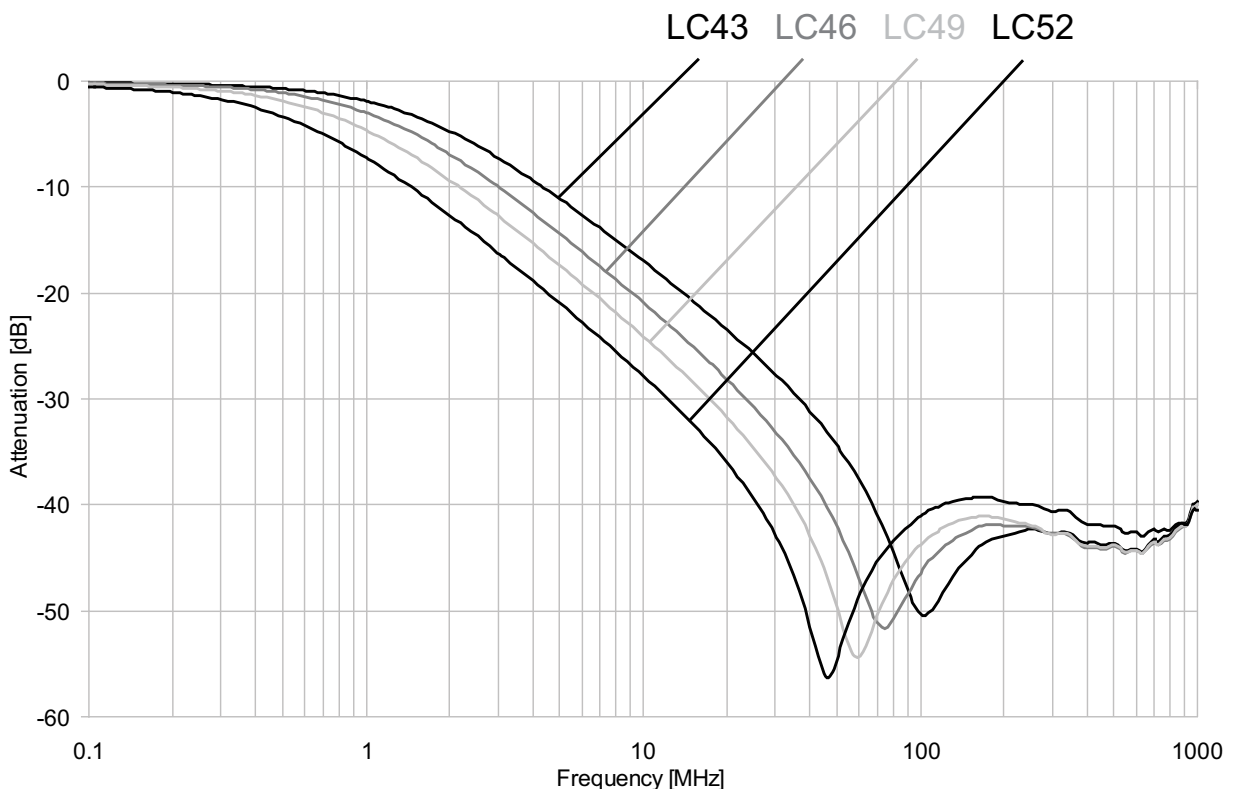

* Note: All filters characteristics subject to change without prior notice.

LC&CL Filter

Audio	LF	MF	HF	VHF	UHF
$f \leq 30\text{kHz}$	$30\text{kHz} \leq f \leq 300\text{kHz}$	$300\text{kHz} \leq f \leq 3\text{MHz}$	$3\text{MHz} \leq f \leq 30\text{MHz}$	$30\text{MHz} \leq f \leq 300\text{MHz}$	$300\text{MHz} \leq f \leq 3\text{GHz}$

Typical cutoff frequency (-3dB) $f_{\infty} \geq 30\text{kHz}$.

Minimum Attenuation

Filter Code (*)	Typical Cap. [nF] (2)	f_{∞} [kHz] Typical (3)	Min. Attenuation [dB] VS. Frequency [MHz] (1)								
			1	5	10	30	50	100	300	500	1000
LC63	22	265	8	22	25	30	31	31	34	36	30
LC66	33	179	11	26	31	42	41	35	35	37	31
LC73	180	38	25	40	50	44	40	35	36	37	34
LC75	220	31	28	44	56	43	40	35	36	38	32

(*) For CL filter replace LC with CL

- (1) Measured in 50Ω system according to MIL-STD -220, no load.
- (2) Capacitance tolerance: ±20%. For other capacitance values, contact sales.
- (3) For estimation of the filter cut off frequency in non-50Ω system please refer to the design notes.

Typical measured filter attenuation

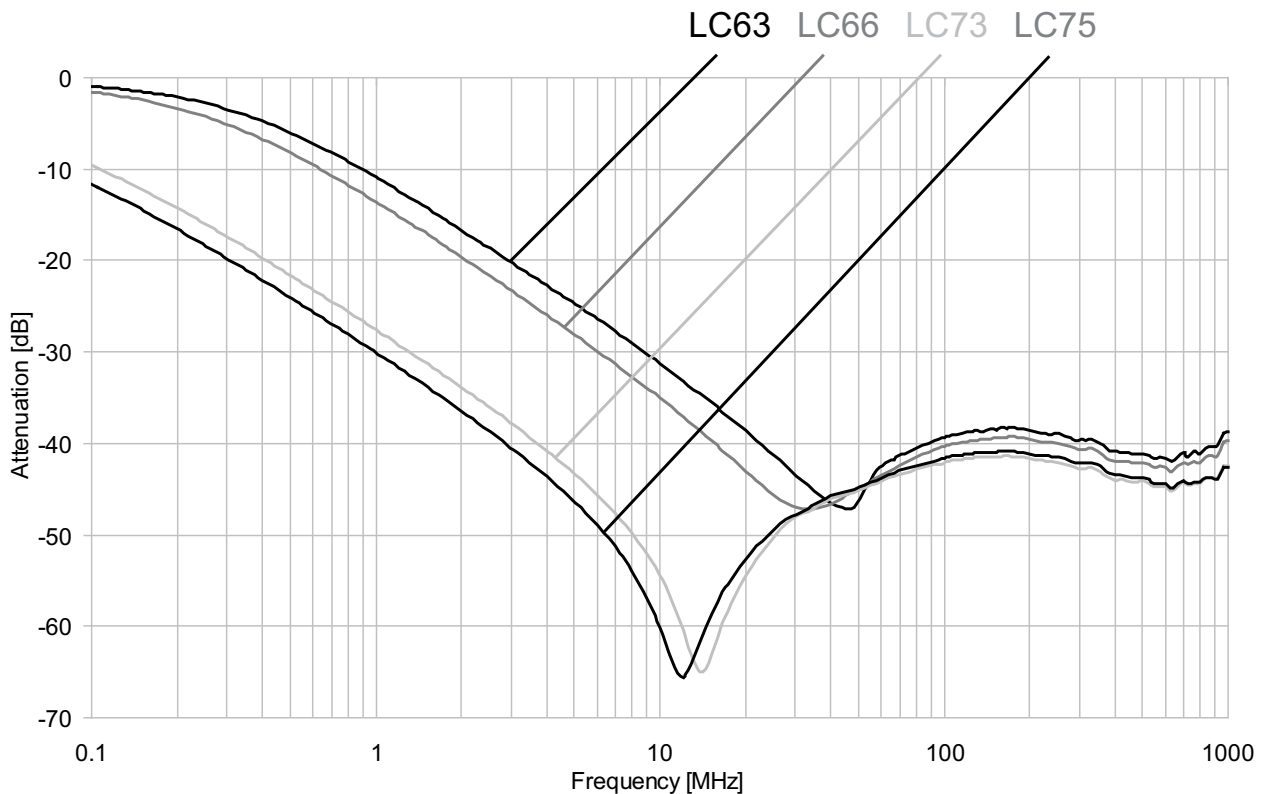

* Note: All filters characteristics subject to change without prior notice.

LC&CL Filter

Audio	LF	MF	HF	VHF	UHF
$f \leq 30\text{kHz}$	$30\text{kHz} \leq f \leq 300\text{kHz}$	$300\text{kHz} \leq f \leq 3\text{MHz}$	$3\text{MHz} \leq f \leq 30\text{MHz}$	$30\text{MHz} \leq f \leq 300\text{MHz}$	$300\text{MHz} \leq f \leq 3\text{GHz}$

Typical cutoff frequency (-3dB) $f_{co} \leq 30\text{kHz}$.

Minimum Attenuation

Filter Code (*)	Typical Cap. [µF] (2)	f_{co} [kHz] Typical (3)	Min. Attenuation [dB] VS. Frequency [MHz] (1)								
			1	5	10	30	50	100	300	500	1000
LC89	0.47	11.5	35	55	51	40	38	33	32	31	30
LC91	1	6.2	41	60	40	40	37	32	31	31	30
LC96	10	0.68	60	55	49	42	39	34	34	33	30

(*) For CL filter replace LC with CL

(1) Measured in 50Ω system according to MIL-STD -220, no load.

(2) Capacitance tolerance: ±20%. For other capacitance values, contact sales.

(3) For estimation of the filter cut off frequency in non-50Ω system please refer to the design notes.

Typical measured filter attenuation

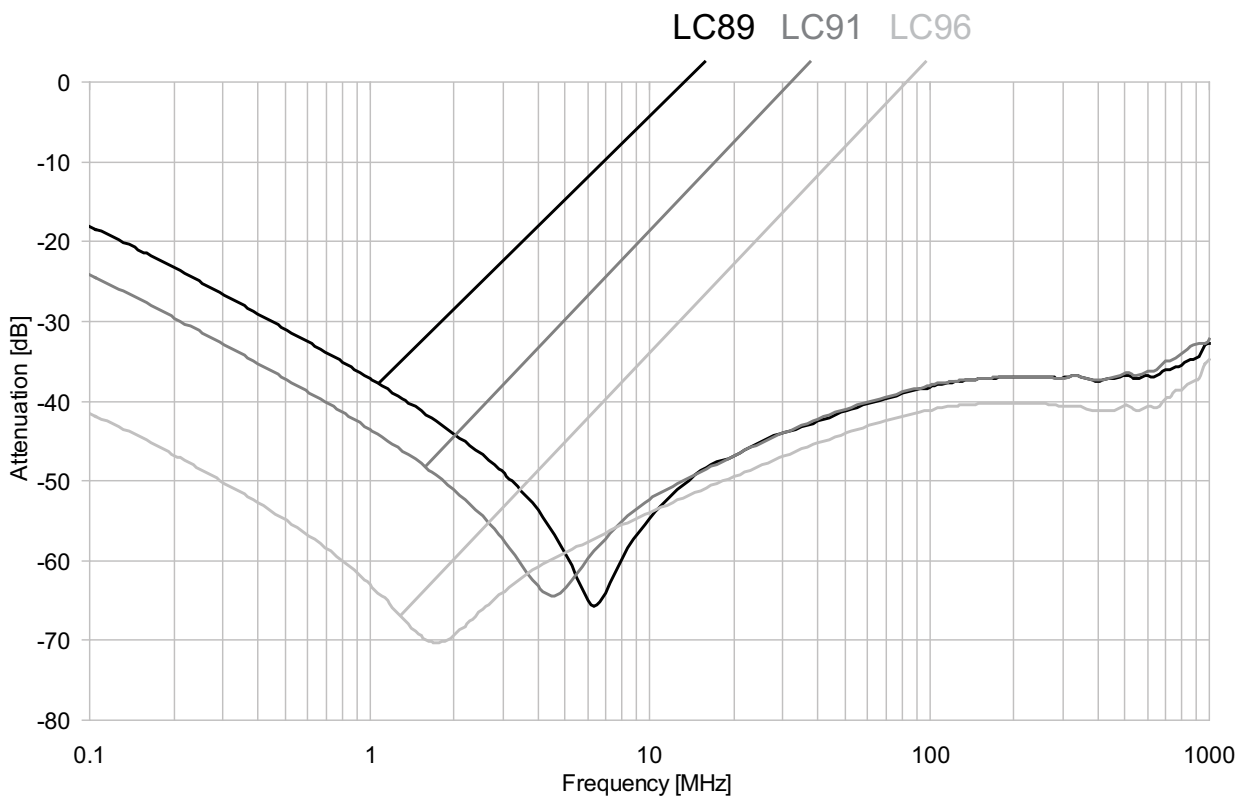

* Note: All filters characteristics subject to change without prior notice.

π Filter

Audio	LF	MF	HF	VHF	UHF
$f \leq 30\text{kHz}$	$30\text{kHz} \leq f \leq 300\text{kHz}$	$300\text{kHz} \leq f \leq 3\text{MHz}$	$3\text{MHz} \leq f \leq 30\text{MHz}$	$30\text{MHz} \leq f \leq 300\text{MHz}$	$300\text{MHz} \leq f \leq 3\text{GHz}$

Typical cutoff frequency (-3dB) $f_{\infty} \geq 30\text{MHz}$.

Minimum Attenuation

Filter Code	Typical Cap. [pF] (2)	f_{∞} [MHz] Typical (3)	Min. Attenuation [dB] VS. Frequency [MHz] (1)								
			1	5	10	30	50	100	300	500	1000
PP04	44	95	0	0	0	0	0	1	25	35	60
PP10	94	65.5	0	0	0	0	0	6	31	51	56
PP15	164	34.8	0	0	0	0	3	12	44	67	46

- (1) Measured in 50Ω system according to MIL-STD -220, no load.
- (2) Capacitance tolerance: ±20%. For other capacitance values, contact technical support.
- (3) For estimation of the filter cut off frequency in non-50Ω system please refer to the design notes.

Typical measured filter attenuation

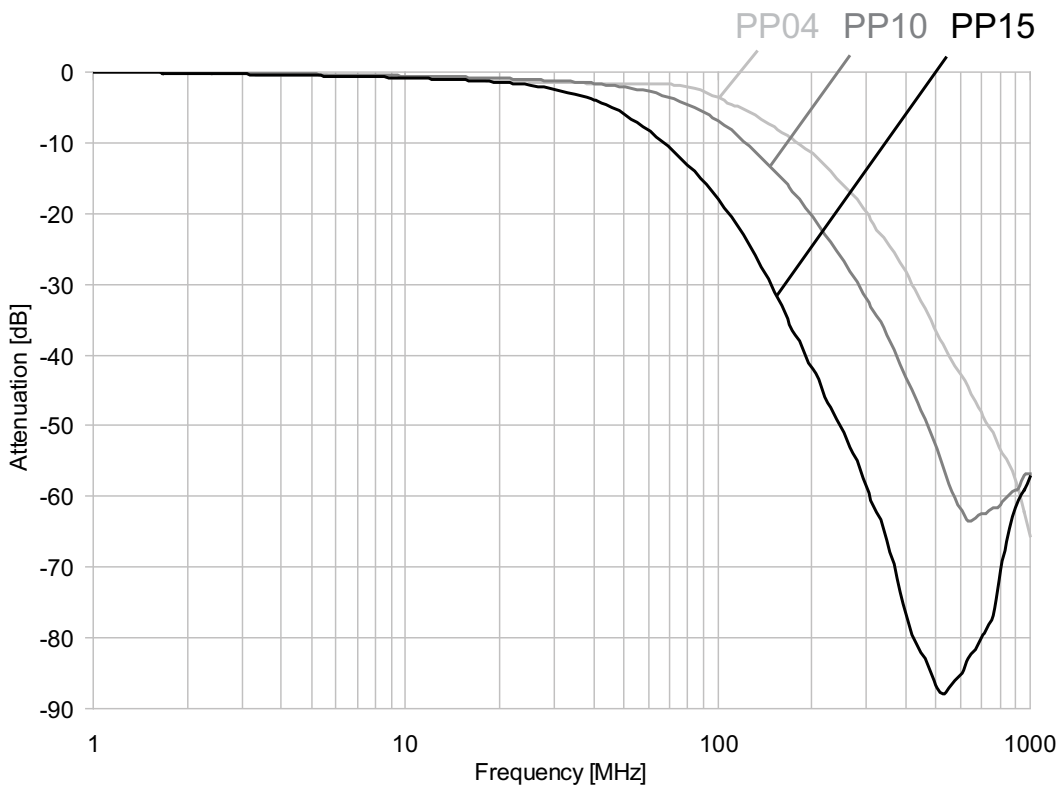

* Note: All filters characteristics subject to change without prior notice.

π Filter

Audio	LF	MF	HF	VHF	UHF
$f \leq 30\text{kHz}$	$30\text{kHz} \leq f \leq 300\text{kHz}$	$300\text{kHz} \leq f \leq 3\text{MHz}$	$3\text{MHz} \leq f \leq 30\text{MHz}$	$30\text{MHz} \leq f \leq 300\text{MHz}$	$300\text{MHz} \leq f \leq 3\text{GHz}$

Typical cutoff frequency (-3dB) $f_{co} \geq 3\text{MHz}$.

Minimum Attenuation

Filter Code	Typical Cap. [pF] (2)	f_{co} [MHz] Typical (3)	Min. Attenuation [dB] VS. Frequency [MHz] (1)								
			1	5	10	30	50	100	300	500	1000
PP24	240	25.3	0	0	0	2	6	15	50	68	53
PP28	440	14.5	0	0	0	6	12	24	72	70	53
PP32	940	7.6	0	0	2	10	18	32	70	65	50
PP36	2000	3.8	0	2	6	20	31	52	61	58	44

(1) Measured in 50Ω system according to MIL-STD -220, no load.

(2) Capacitance tolerance: ±20%. For other capacitance values, contact technical support.

(3) For estimation of the filter cut off frequency in non-50Ω system please refer to the design notes.

Typical measured filter attenuation

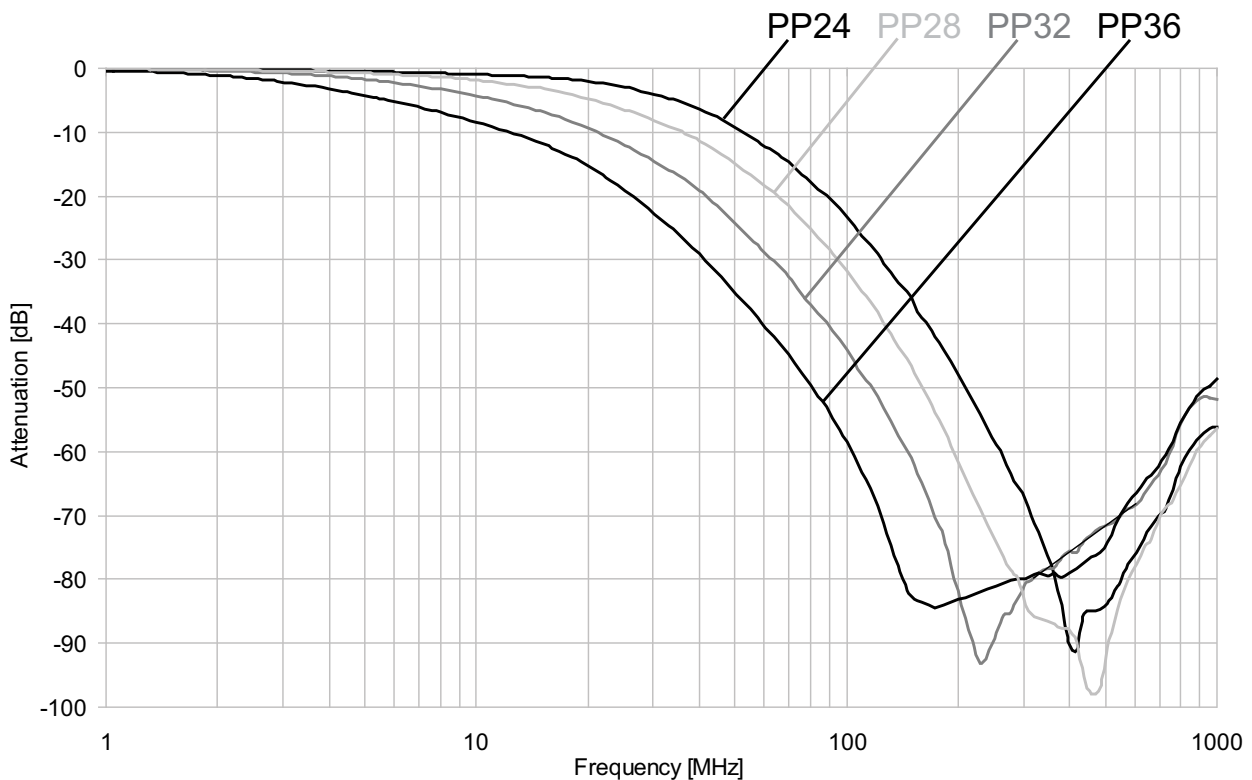

* Note: All filters characteristics subject to change without prior notice.

π Filter

Audio	LF	MF	HF	VHF	UHF
$f \leq 30\text{kHz}$	$30\text{kHz} \leq f \leq 300\text{kHz}$	$300\text{kHz} \leq f \leq 3\text{MHz}$	$3\text{MHz} \leq f \leq 30\text{MHz}$	$30\text{MHz} \leq f \leq 300\text{MHz}$	$300\text{MHz} \leq f \leq 3\text{GHz}$

Typical cutoff frequency (-3dB) $f_{\infty} \geq 300\text{kHz}$.

Minimum Attenuation

Filter Code	Typical Cap. [nF] (2)	f_{∞} [MHz] Typical (3)	Min. Attenuation [dB] VS. Frequency [MHz] (1)								
			1	5	10	30	50	100	300	500	1000
PP43	3	2.5	0	3	8	26	38	63	62	59	45
PP46	4.4	1.7	0	7	12	33	47	64	62	60	47
PP49	9.4	0.76	2	8	18	46	60	60	61	60	52
PP52	13.6	0.46	5	15	28	57	62	62	62	61	52
PP55	20	0.3	7	18	35	65	69	65	63	62	53

- (1) Measured in 50Ω system according to MIL-STD -220, no load.
- (2) Capacitance tolerance: ±20%. For other capacitance values, contact technical support.
- (3) For estimation of the filter cut off frequency in non-50Ω system please refer to the design notes.

Typical measured filter attenuation

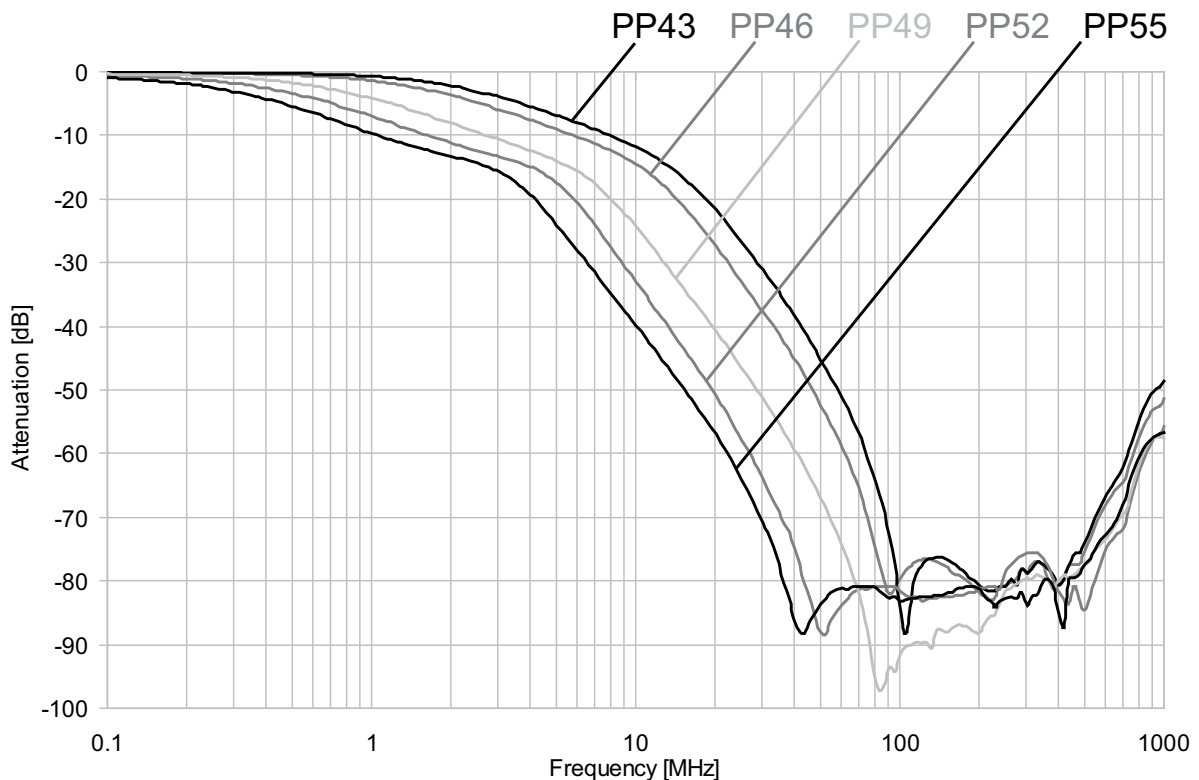

* Note: All filters characteristics subject to change without prior notice.

π Filter

Audio	LF	MF	HF	VHF	UHF
$f \leq 30\text{kHz}$	$30\text{kHz} \leq f \leq 300\text{kHz}$	$300\text{kHz} \leq f \leq 3\text{MHz}$	$3\text{MHz} \leq f \leq 30\text{MHz}$	$30\text{MHz} \leq f \leq 300\text{MHz}$	$300\text{MHz} \leq f \leq 3\text{GHz}$

Typical cutoff frequency (-3dB) $f_{co} \geq 30\text{kHz}$.

Minimum Attenuation

Filter Code	Typical Cap. [nF] (2)	f_{co} [kHz] Typical (3)	Min. Attenuation [dB] VS. Frequency [MHz] (1)								
			1	5	10	30	50	100	300	500	1000
PP62	24	245	8	21	39	69	65	64	64	63	52
PP65	44	100	13	33	48	62	63	62	62	61	51
PP68	66	96.5	15	40	57	66	66	66	63	62	50
PP71	94	67.7	17	47	63	75	71	68	63	62	50

(1) Measured in 50Ω system according to MIL-STD -220, no load.

(2) Capacitance tolerance: ±20%. For other capacitance values, contact technical support.

(3) For estimation of the filter cut off frequency in non-50Ω system please refer to the design notes.

Typical measured filter attenuation

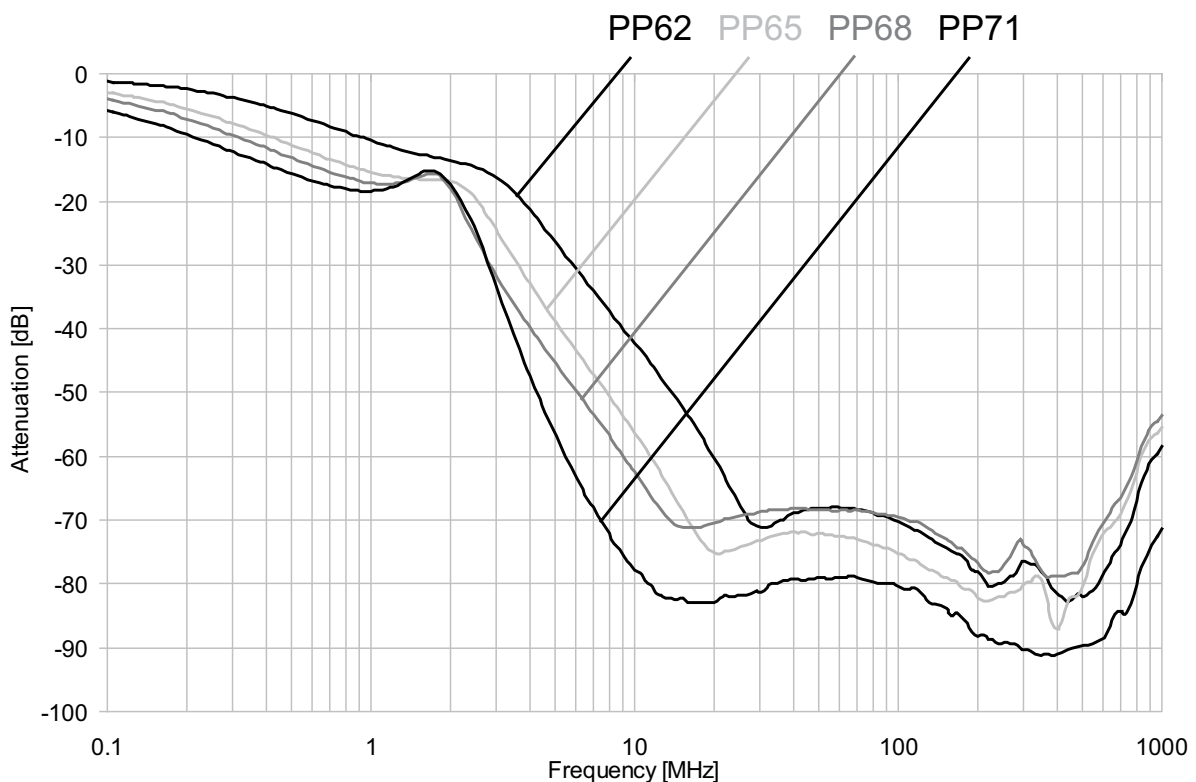

* Note: All filters characteristics subject to change without prior notice.

π Filter

Audio	LF	MF	HF	VHF	UHF
$f \leq 30\text{kHz}$	$30\text{kHz} \leq f \leq 300\text{kHz}$	$300\text{kHz} \leq f \leq 3\text{MHz}$	$3\text{MHz} \leq f \leq 30\text{MHz}$	$30\text{MHz} \leq f \leq 300\text{MHz}$	$300\text{MHz} \leq f \leq 3\text{GHz}$

Typical cutoff frequency (-3dB) $f_{\infty} \leq 30\text{kHz}$.

Minimum Attenuation

Filter Code	Typical Cap. [μF] (2)	f_{∞} [kHz] Typical (3)	Min. Attenuation [dB] VS. Frequency [MHz] (1)								
			1	5	10	30	50	100	300	500	1000
PP80	0.44	12	26	71	69	67	62	60	59	62	50
PP84	0.94	6.5	45	70	65	60	60	55	55	55	45
PP87	2	3.2	63	72	70	66	61	60	59	64	49
PP95	20	0.35	70	74	72	65	63	60	58	57	46

- (1) Measured in 50Ω system according to MIL-STD -220, no load.
- (2) Capacitance tolerance: $\pm 20\%$. For other capacitance values, contact technical support.
- (3) For estimation of the filter cut off frequency in non-50Ω system please refer to the design notes.

Typical measured filter attenuation

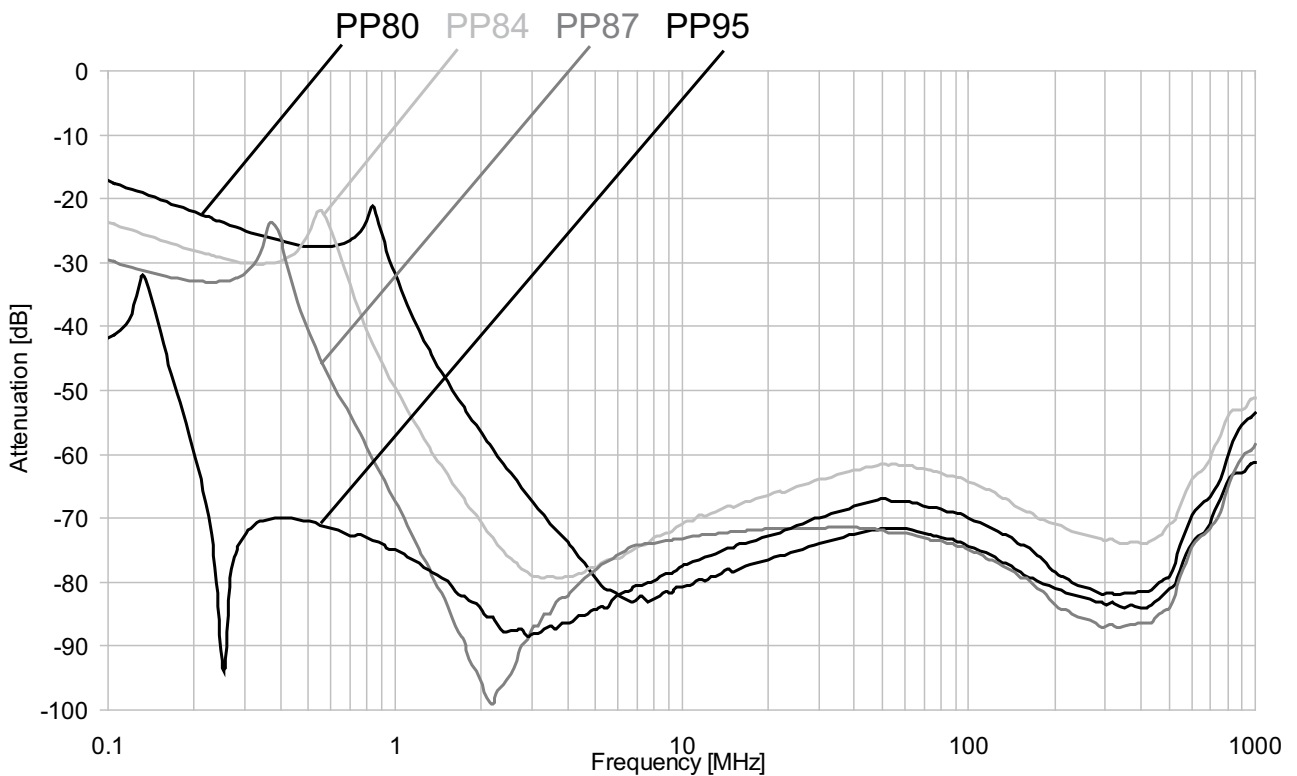

* Note: All filters characteristics subject to change without prior notice.

Hi Filter

Audio	LF	MF	HF	VHF	UHF
$f \leq 30\text{kHz}$	$30\text{kHz} \leq f \leq 300\text{kHz}$	$300\text{kHz} \leq f \leq 3\text{MHz}$	$3\text{MHz} \leq f \leq 30\text{MHz}$	$30\text{MHz} \leq f \leq 300\text{MHz}$	$300\text{MHz} \leq f \leq 3\text{GHz}$

Typical cutoff frequency (-3dB) $f_{co} \geq 30\text{MHz}$.

Minimum Attenuation

Filter Code	Typical Cap. [pF] (2)	f_{co} [MHz] Typical (3)	Min. Attenuation [dB] VS. Frequency [MHz] (1)								
			1	5	10	30	50	100	300	500	1000
HH10	91	40	0	0	0	0	2	8	32	55	65
HH15	186	25	0	0	0	2	4	10	50	80	64

(1) Measured in 50Ω system according to MIL-STD -220, no load.

(2) Capacitance tolerance: ±20%. For other capacitance values, contact technical support.

(3) For estimation of the filter cut off frequency in non-50Ω system please refer to the design notes.

Typical measured filter attenuation

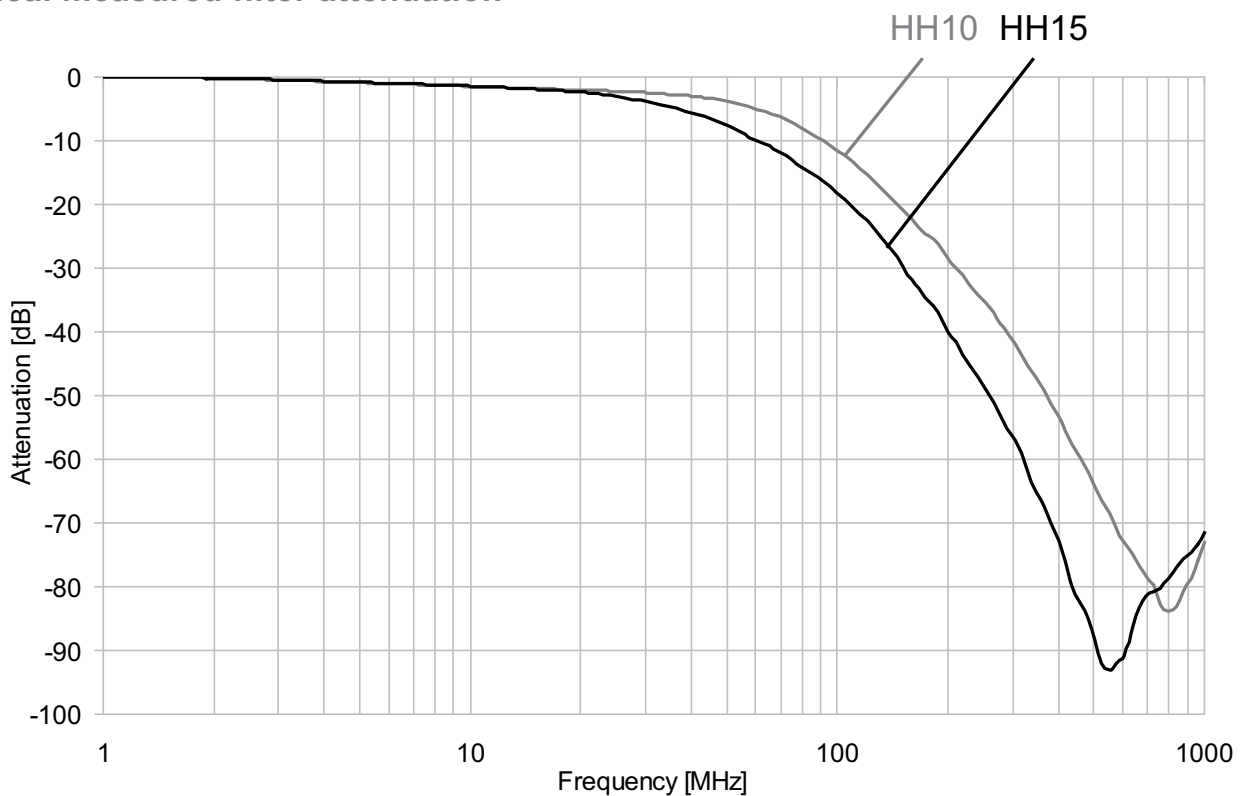

* Note: All filters characteristics subject to change without prior notice.

Hi Filter

Audio	LF	MF	HF	VHF	UHF
$f \leq 30\text{kHz}$	$30\text{kHz} \leq f \leq 300\text{kHz}$	$300\text{kHz} \leq f \leq 3\text{MHz}$	$3\text{MHz} \leq f \leq 30\text{MHz}$	$30\text{MHz} \leq f \leq 300\text{MHz}$	$300\text{MHz} \leq f \leq 3\text{GHz}$

Typical cutoff frequency (-3dB) $f_{co} \geq 3\text{MHz}$.

Minimum Attenuation

Filter Code	Typical Cap. [pF] (2)	f_{co} [MHz] Typical (3)	Min. Attenuation [dB] VS. Frequency [MHz] (1)								
			1	5	10	30	50	100	300	500	1000
HH28	460	11.6	0	0	1	7	12	25	72	80	65
HH32	910	6.6	0	0	3	12	20	40	65	65	65
HH36	1940	3.6	0	2	7	19	33	55	65	66	66

(1) Measured in 50Ω system according to MIL-STD -220, no load.

(2) Capacitance tolerance: ±20%. For other capacitance values, contact technical support.

(3) For estimation of the filter cut off frequency in non-50Ω system please refer to the design notes.

Typical measured filter attenuation

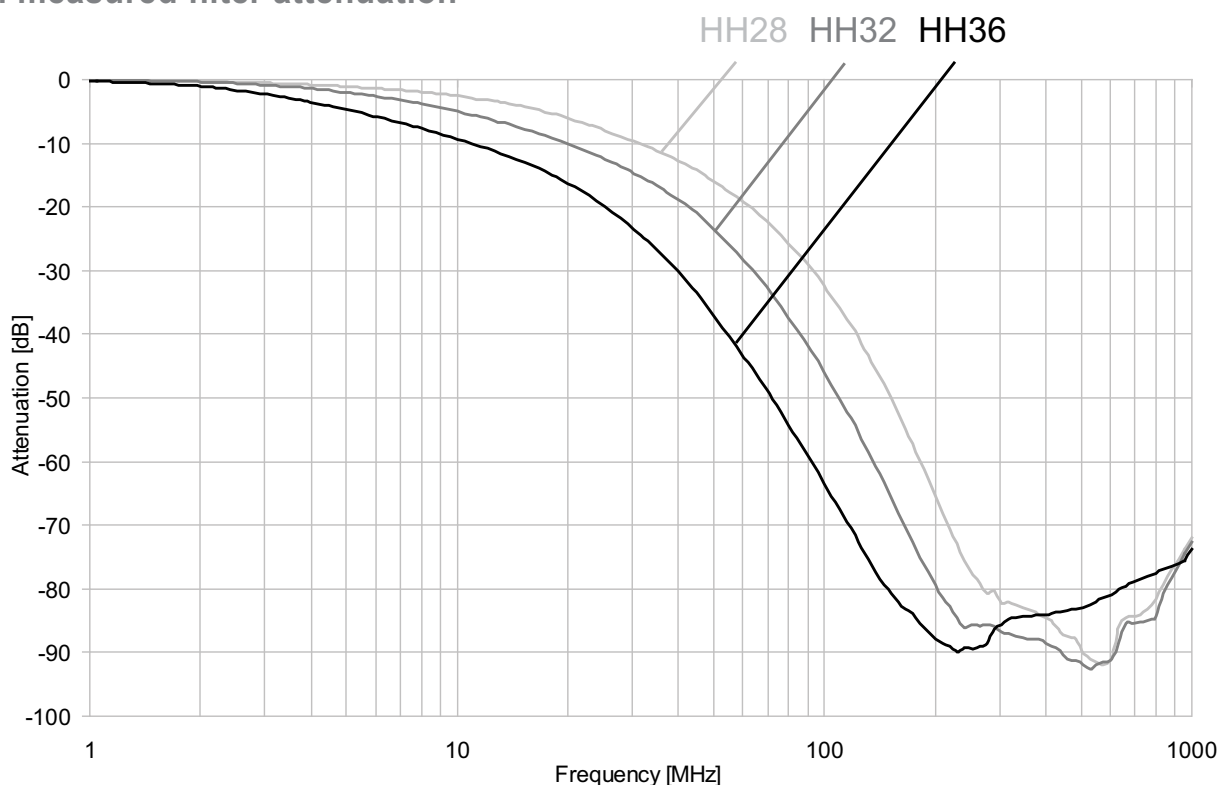

* Note: All filters characteristics subject to change without prior notice.

Hi Filter

Audio	LF	MF	HF	VHF	UHF
$f \leq 30\text{kHz}$	$30\text{kHz} \leq f \leq 300\text{kHz}$	$300\text{kHz} \leq f \leq 3\text{MHz}$	$3\text{MHz} \leq f \leq 30\text{MHz}$	$30\text{MHz} \leq f \leq 300\text{MHz}$	$300\text{MHz} \leq f \leq 3\text{GHz}$

Typical cutoff frequency (-3dB) $f_{co} \geq 300\text{MHz}$.

Minimum Attenuation

Filter Code	Typical Cap. [nF] (2)	f_{co} [MHz] Typical (3)	Min. Attenuation [dB] VS. Frequency [MHz] (1)								
			1	5	10	30	50	100	300	500	1000
HH46	3.1	2.3	0	5	8	28	42	70	72	79	62
HH49	9.1	0.8	2	11	19	54	64	75	80	78	60
HH52	13.4	0.5	4	13	25	62	68	75	76	79	65
HH55	19.4	0.34	6	15	30	65	70	75	76	80	65

(1) Measured in 50Ω system according to MIL-STD -220, no load.

(2) Capacitance tolerance: ±20%. For other capacitance values, contact technical support.

(3) For estimation of the filter cut off frequency in non-50Ω system please refer to the design notes.

Typical measured filter attenuation

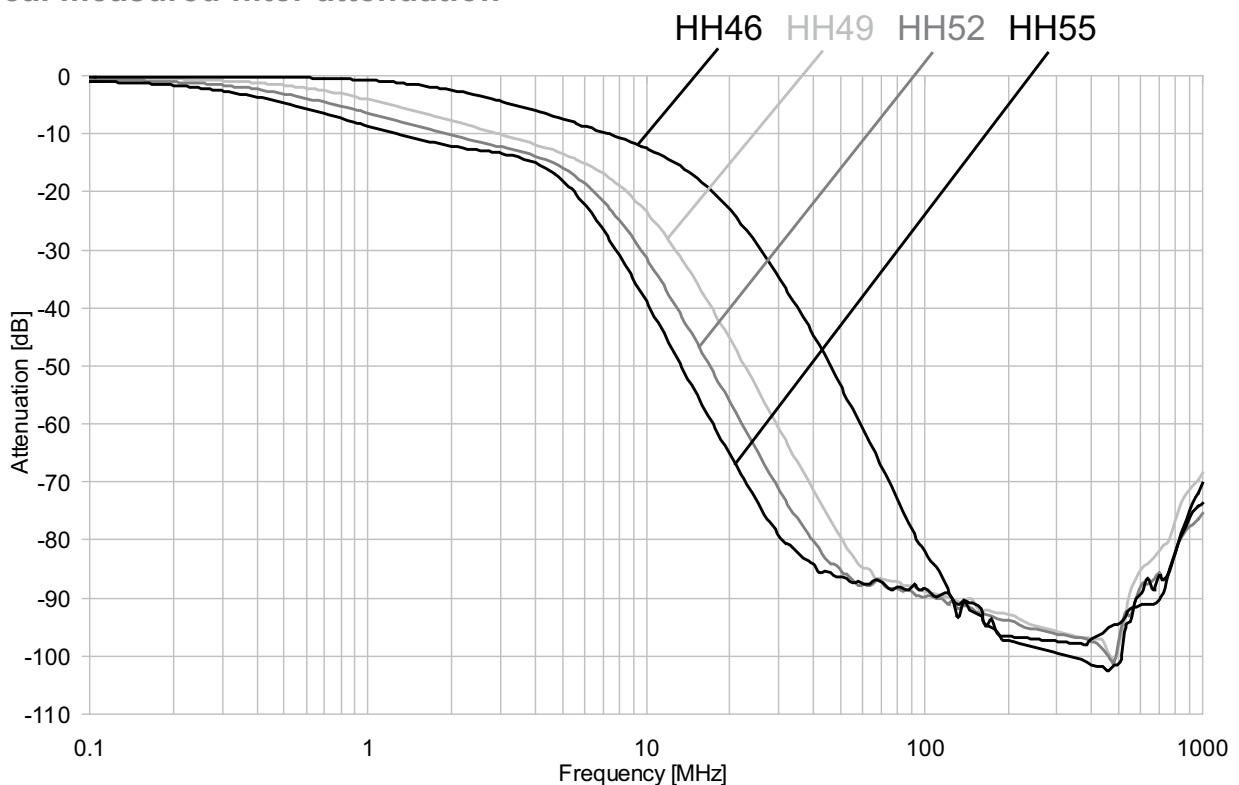

* Note: All filters characteristics subject to change without prior notice.

Hi Filter

Audio	LF	MF	HF	VHF	UHF
$f \leq 30\text{kHz}$	$30\text{kHz} \leq f \leq 300\text{kHz}$	$300\text{kHz} \leq f \leq 3\text{MHz}$	$3\text{MHz} \leq f \leq 30\text{MHz}$	$30\text{MHz} \leq f \leq 300\text{MHz}$	$300\text{MHz} \leq f \leq 3\text{GHz}$

Typical cutoff frequency (-3dB) $f_{co} \geq 30\text{MHz}$.

Minimum Attenuation

Filter Code	Typical Cap. [nF] (2)	f_{co} [kHz] Typical (3)	Min. Attenuation [dB] VS. Frequency [MHz] (1)								
			1	5	10	30	50	100	300	500	1000
HH62	25.6	265	8	20	45	65	66	66	67	70	60
HH65	42	118	11	31	57	68	68	67	70	70	60
HH68	63	99	13	44	65	68	67	67	71	69	65
HH71	91	75	15	53	75	70	67	66	68	71	65

- (1) Measured in 50Ω system according to MIL-STD -220, no load.
- (2) Capacitance tolerance: ±20%. For other capacitance values, contact technical support.
- (3) For estimation of the filter cut off frequency in non-50Ω system please refer to the design notes.

Typical measured filter attenuation

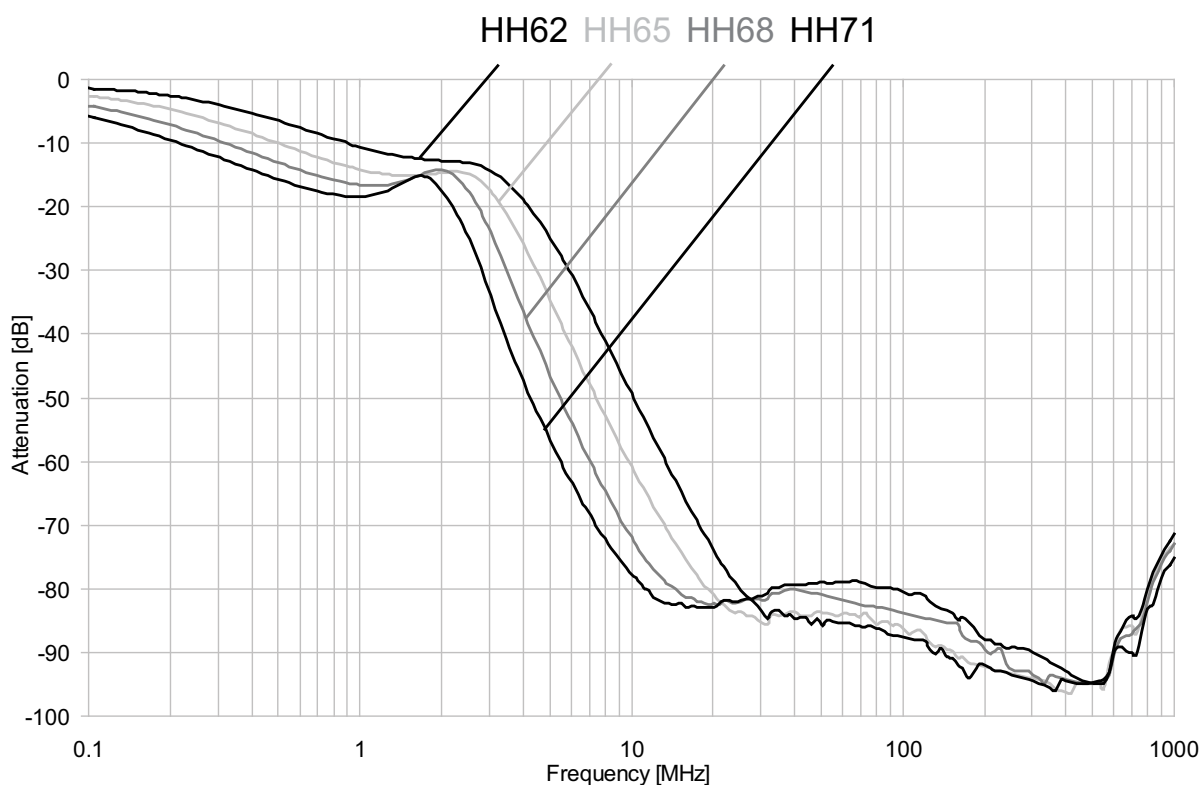

* Note: All filters characteristics subject to change without prior notice.

Bidirectional Varistors

RF Immunity's technology integrates homogenous or selective transient protection (using Varistors) into connectors without increasing dimensions. This section will help to define a homogenous transient protection Connector or transient protection added to a Filtered Connector.

The technology is based on multilayer ZnO (Zink-Oxide) transient suppressor, designed to protect sensitive circuit from transient caused by inductive switching, ESD, EFT, lightning and other phenomenon as IEC 61000-4-2 specifies.

There are two main advantages using Varistors inside the connector shell instead of placing the components on board:

1. The connector is the entry point to the equipment; therefore, this is the weakest point to absorb ESD, lightning and other non-conducted transients. Placing the protection at this point will ensure that no outer transient will enter to the equipment by air-discharge or by conductance through connector contacts and into the sensitive circuits.
2. Comparing to onboard components, the response time of Varistors inside the connector is shorter due to the Varistors grounding point, which is the connector metal shell assembled directly to the equipment enclosure. The onboard components equivalent series inductance plus the unknown elements of the printed circuit traces will cause longer response time and the transient suppressors might be less effective.

Although the Varistors have capacitance, it should not be considered as part of the filter module but as added capacitance due to its tolerances. Therefore, when choosing Transient Protection, special care should be taken for the maximum capacitance level. Low capacitance Varistors are available.

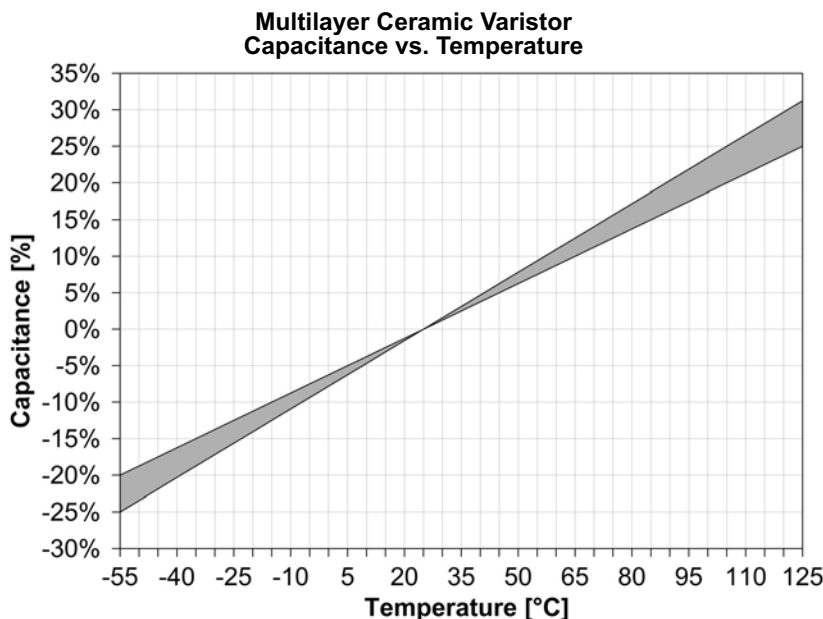
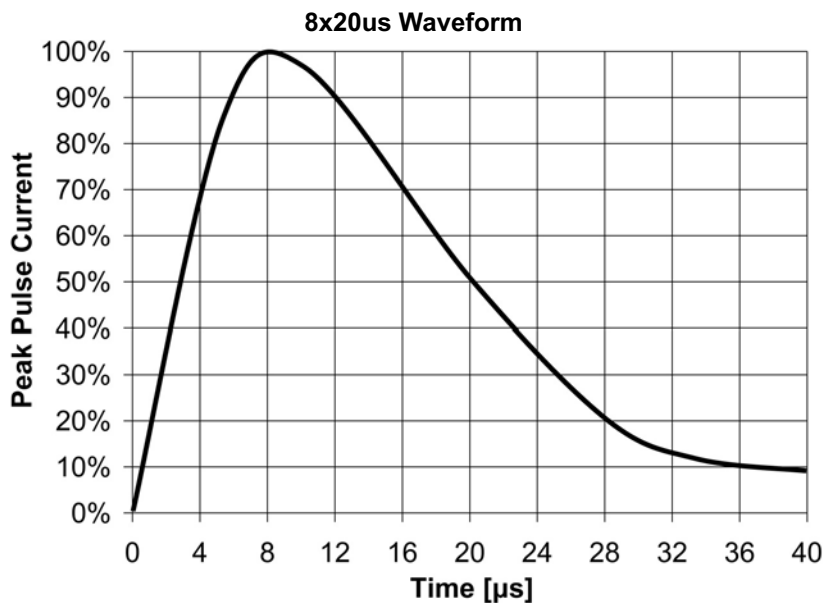

* Note: For higher energy Transient Protection contact sales.

Bidirectional Varistors

Note: For higher energy and/or low capacitance Transient Protection contact sales.

Energy ⁽¹⁾ [J]	Transient Protection Code	Working Voltage		Breakdown Voltage @ 1mA _{DC}		Clamping Voltage ⁽²⁾ [V]	Peak Current ⁽³⁾ (A)	Typical Capacitance ⁽⁴⁾ [pF]
		[V _{DC}]	[V _{AC}]	Min. [V]	Max. [V]			
0.1	ZA03	3.3	2.3	3.7	7	13	30	1500
	ZA05	5.5	4.0	6.8	10.2	18	30	800
	ZA09	9.0	6.4	10.8	16	25.5	30	600
	ZA14	14	10	15.9	21.5	32	30	400
	ZA18	18	13	22	28	50	30	200
	ZA26	26	18	31	38	60	30	150
	ZA30	30	21	37	46	74	30	150
0.2	ZB03	3.3	2.3	3.7	7	13	45	3000
	ZB05	5.5	4	6.8	10.2	18	45	1600
	ZB09	9.0	6.4	10.8	16	25.5	45	1200
	ZB14	14	10	15.9	21.5	32	45	800
	ZB18	18	13	22	28	50	45	400
	ZB26	26	18	31	38	60	45	300
	ZB30	30	21	37	46	74	45	300
0.3	ZC03	3.3	2.3	3.7	7	13	120	5000
	ZC05	5.5	4	6.8	10.2	18	120	3000
	ZC14	14	10	15.9	21.5	32	120	900
	ZC18	18	13	22	28	50	100	600
	ZC26	26	18	31	38	60	100	250
0.6	ZF03	3.3	2.3	3.7	7	13	180	10000
	ZF05	5.5	4	6.8	10.2	18	180	6000
	ZF14	14	10	15.9	21.5	32	180	1800
	ZF18	18	13	22	28	50	180	1200
	ZF26	26	18	31	38	60	180	500

Transient Protection

(1) Non-Repetitive Surge Energy, 10x1000µs Waveform

(2) Measured @1A_{DC}, 8x20µs Waveform

(3) Peak Transient Current Rating, 8x20µs Waveform

(4) Measured @ 0.5V_{RMS}/1kHz.

(5) Maximum Leakage Current 100µA @ W.V._{DC}

Codes for homogenous C Filter combined with Bidirectional Varistors

			Filter Code ¹											
			Cap.											
Working Voltage [VDC]	Transient Protection Code ²	Energy [J]	CC36	CC39	CC42	CC45	CC54	CC58	CC62	CC66	CC72	CC74	CC76	CC78
			470pF	1nF	2.2nF	3.9nF	4.7nF	6.8nF	10nF	15nF	33nF	47nF	100nF	220nF
3.3	ZA03	0.1					YA15	YA22	YA29	YA36	YA43	YA50	YA57	YA64
							6.2nF	8.3nF	11.5nF	16.5nF	34.5nF	48.5nF	101.5nF	221.5nF
	ZB03	0.2					YK15	YK22	YK29	YK36	YK43	YK50	YK57	YK64
							7.7nF	9.8nF	13nF	18nF	36nF	50nF	103nF	223nF
	ZC03	0.3							YF17	YF22	YF27	YF32	YF37	
									20nF	38nF	52nF	105nF	225nF	
	ZF03	0.6							YL17	YL22	YL27	YL32	YL37	
									25nF	43nF	57nF	110nF	230nF	
5.6	ZA05	0.1				YA9	YA16	YA23	YA30	YA37	YA44	YA51	YA58	YA65
						4.7nF	5.5nF	7.6nF	10.8nF	15.8nF	33.8nF	47.8nF	100.8nF	220.8nF
	ZB05	0.2				YK9	YK16	YK23	YK30	YK37	YK44	YK51	YK58	YK65
						5.5nF	6.3nF	8.4nF	11.6nF	16.6nF	34.6nF	48.6nF	101.6nF	221.6nF
	ZC05	0.3							YF13	YF18	YF23	YF28	YF33	YF38
									13nF	18nF	36nF	50nF	103nF	223nF
	ZF05	0.6							YL13	YL18	YL23	YL28	YL33	YL38
									16nF	21nF	39nF	53nF	106nF	226nF
9	ZA09	0.1				YA10	YA17	YA24	YA31	YA38	YA45	YA52	YA59	YA66
						4.5nF	5.3nF	7.4nF	10.6nF	15.6nF	33.6nF	47.6nF	100.6nF	220.6nF
	ZB09	0.2				YK10	YK17	YK24	YK31	YK38	YK45	YK52	YK59	YK66
						5.1nF	5.9nF	8nF	11.2nF	16.2nF	34.2nF	48.2nF	101.2nF	221.2nF
14	ZA14	0.1				YA11	YA18	YA25	YA32	YA39	YA46	YA53	YA60	YA67
						4.3nF	5.1nF	7.2nF	10.4nF	15.4nF	33.4nF	47.4nF	100.4nF	220.4nF
	ZB14	0.2				YK11	YK18	YK25	YK32	YK39	YK46	YK53	YK60	YK67
						4.7nF	5.5nF	7.6nF	10.8nF	15.8nF	33.8nF	47.8nF	100.8nF	220.8nF
	ZC14	0.3				YF04	YF07	YF10	YF14	YF19	YF24	YF29	YF34	YF39
						4.8nF	5.6nF	7.7nF	10.9nF	15.9nF	33.9nF	47.9nF	100.9nF	220.9nF
	ZF14	0.6				YL04	YL07	YL10	YL14	YL19	YL24	YL29	YL34	YL39
						5.7nF	6.5nF	8.6nF	11.8nF	16.8nF	34.8nF	48.8nF	101.8nF	221.8nF
18	ZA18	0.1			YA06	YA12	YA19	YA26	YA33	YA40	YA47	YA54	YA61	YA68
					2.4nF	4.1nF	4.9nF	7nF	10.2nF	15.2nF	33.2nF	47.2nF	100.2nF	220.2nF
	ZB18	0.2			YK06	YK12	YK19	YK26	YK33	YK40	YK47	YK54	YK61	YK68
					2.6nF	4.3nF	5.1nF	7.2nF	10.4nF	15.4nF	33.4nF	47.4nF	100.4nF	220.4nF
	ZC18	0.3			YF02	YF05	YF08	YF11	YF15	YF20	YF25	YF30	YF35	YF40
					2.8nF	4.5nF	5.3nF	7.4nF	10.6nF	15.6nF	33.6nF	47.6nF	100.6nF	220.6nF
	ZF18	0.6			YL02	YL05	YL08	YL11	YL15	YL20	YL25	YL30	YL35	YL40
					3.4nF	5.1nF	5.9nF	8nF	11.2nF	16.2nF	34.2nF	48.2nF	100.2nF	221.2nF
26	ZA26	0.1	YA01	YA04	YA07	YA13	YA20	YA27	YA34	YA41	YA48	YA55	YA62	YA69
			620pF	1.15nF	2.35nF	4.05nF	4.85nF	6.95nF	10.15nF	15.15nF	33.15nF	47.15nF	100.15nF	220.15nF
	ZB26	0.2	YK01	YK03	YK07	YK13	YK20	YK27	YK34	YK41	YK48	YK55	YK62	YK69
			770pF	1.3nF	2.5nF	4.2nF	5nF	7.1nF	10.3nF	15.3nF	33.3nF	47.3nF	100.3nF	220.3nF
	ZC26	0.3		YF01	YF03	YF06	YF09	YF19	YF16	YF21	YF26	YF31	YF36	YF41
				1.25nF	2.45nF	4.15nF	4.95nF	7.05nF	10.25nF	15.25nF	33.25nF	47.25nF	100.25nF	220.25nF
	ZF26	0.6		YL01	YL03	YL06	YL09	YL12	YL16	YL21	YL26	YL31	YL36	YL41
				1.5nF	2.7nF	4.4nF	5.2nF	7.3nF	10.5nF	15.5nF	33.5nF	47.5nF	100.5nF	220.5nF
30	ZA30	0.1	YA02	YA04	YA08	YA14	YA21	YA28	YA35	YA42	YA49	YA56	YA63	YA70
			620pF	1.15nF	2.35nF	4.05nF	4.85nF	6.95nF	10.15nF	15.15nF	33.15nF	47.15nF	100.15nF	220.15nF
	ZB30	0.2	YK02	YK04	YK08	YK14	YK21	YK28	YK35	YK42	YK49	YK56	YK63	YK70
			770pF	1.3nF	2.5nF	4.2nF	5nF	7.1nF	10.3nF	15.3nF	33.3nF	47.3nF	100.3nF	220.3nF

- (1) Refer to the attenuation on pages 38-42.
- (2) Refer to the applicability on pages 15, 24, 33 and to the characteristics on page 63.

Example:

Assuming that a CC45 filter and a ZA14 transient protection are selected for all the connector contacts, the combined code can be extracted by finding the intersection of the CC45 **column** with the ZA14 **row**. The combined code is YA11. The typical capacitance of the combined filter is **4.3nF**.

Refer to the design notes (page 92) for estimation of the cutoff frequency (f_{co}) of the combined filter. If the estimated f_{co} is too low, select a filter with lower capacitance.

Codes for homogenous C² Filter combined with Bidirectional Varistors

			Filter Code ¹												
			Cap.												
Working Voltage [VDC]	Transient Protection Code ²	Energy [J]	CS23	CS27	CS32	CS35	CS38	CS41	CS47	CS50	CF52	CF60	CF62	CF66	CF70
			660pF	940pF	2.4nF	3.6nF	5.7nF	7.8nF	13.6nF	19.7nF	25nF	39.8nF	43nF	66nF	94nF
3.3	ZA03	0.1					YB16 7.2nF	YB23 9.3nF	YB30 15.1nF	YB37 21.2nF	YB44 26.5nF	YB51 41.3nF	YB58 44.5nF	YB65 67.5nF	YB72 95.5nF
	ZC03	0.3								YG17 24.7nF	YG22 30nF	YG27 44.8nF	YG32 48nF	YG37 71nF	YG42 99nF
5.6	ZA05	0.1				YB10 4.4nF	YB17 6.5nF	YB24 8.6nF	YB31 14.4nF	YB38 20.5nF	YB45 25.8nF	YB52 40.6nF	YB59 43.8nF	YB66 66.8nF	YB73 94.8nF
	ZC05	0.3							YG13 16.6nF	YG18 22.7nF	YG23 28nF	YG28 42.8nF	YG33 46nF	YG38 69nF	YG43 97nF
9	ZA09	0.1		YB05 3nF	YB11 4.2nF	YB18 6.3nF	YB25 8.4nF	YB32 14.2nF	YB39 20.3nF	YB47 25.6nF	YB53 40.4nF	YB60 43.6nF	YB67 66.6nF	YB74 94.6nF	
14	ZA14	0.1		YB06 2.8nF	YB12 4nF	YB19 6.1nF	YB26 8.2nF	YB33 14nF	YB40 20.1nF	YB48 25.4nF	YB54 40.2nF	YB61 43.4nF	YB68 66.4nF	YB75 94.4nF	
	ZC14	0.3			YG04 4.5nF	YG07 6.6nF	YG10 8.7nF	YG14 14.5nF	YG19 20.6nF	YG24 25.9nF	YG29 40.7nF	YG34 43.9nF	YG39 66.9nF	YG44 94.9nF	
18	ZA18	0.1		YB07 2.6nF	YB13 3.8nF	YB20 5.9nF	YB27 8nF	YB34 13.8nF	YB41 19.9nF	YB49 25.2nF	YB55 40nF	YB62 43.2nF	YB69 66.2nF	YB76 94.2nF	
	ZC18	0.3		YG02 3nF	YG05 4.2nF	YG08 6.3nF	YG11 8.4nF	YG15 14.2nF	YG20 20.3nF	YG25 25.6nF	YG30 40.4nF	YG35 43.6nF	YG40 66.6nF	YG45 94.6nF	
26	ZA26	0.1	YB01 810pF	YB03 1.09nF	YB08 2.55nF	YB18 3.75nF	YB21 5.85nF	YB28 7.95nF	YB35 13.75nF	YB42 19.85nF	YB49 25.15nF	YB56 39.95nF	YB63 43.15nF	YB70 66.15nF	YB77 94.15nF
	ZC26	0.3		YG01 1.19nF	YG03 2.65nF	YG06 3.85nF	YG09 5.95nF	YG12 8.05nF	YG16 13.85nF	YG21 19.95nF	YG26 25.25nF	YG31 40.05nF	YG36 43.25nF	YG41 66.25nF	YG46 94.25nF
30	ZA30	0.1	YB02 810pF	YB04 1.09nF	YB09 2.55nF	YB15 3.75nF	YB22 5.85nF	YB29 7.95nF	YB36 13.75nF	YB43 19.85nF	YB50 25.15nF	YB57 39.95nF	YB64 43.15nF	YB71 66.15nF	YB78 94.15nF

Filter & Transient Protection

- (1) Refer to the attenuation on pages 43-47.
- (2) Refer to the applicability on pages 15, 24, 33 and to the characteristics on page 63.

Example:

Assuming that a CS38 filter and a ZA14 transient protection are selected for all the connector contacts, the combined code can be extracted by finding the intersection of the CS38 **column** with the ZA14 **row**. The combined code is YB19. The typical capacitance of the combined filter is **6.1nF**.

Refer to the design notes (page 92) for estimation of the cutoff frequency (f_{cc}) of the combined filter. If the estimated f_{cc} is too low, select a filter with lower capacitance.

Codes for homogenous LC Filter combined with Bidirectional Varistors

Working Voltage [VDC]	Transient Protection Code ²	Energy [J]	Filter Code ¹										
			Cap.										
			LC28	LC32	LC36	LC43	LC46	LC49	LC52	LC63	LC66	LC73	LC75
			470pF	1nF	1.8nF	4.7nF	6.8nF	10nF	15nF	22nF	33nF	180nF	220nF
3.3	ZA03	0.1					YC16	YC23	YC30	YC37	YC44	YC51	YC58
							8.3nF	11.5nF	16.5nF	23.5nF	34.5nF	181.5nF	221.5nF
	ZB03	0.2					YP16	YP23	YP30	YP37	YP44	YP51	YP58
							9.8nF	13nF	18nF	25nF	36nF	183nF	223nF
5.6	ZA05	0.1				YC10	YC17	YC24	YC31	YC31	YC45	YC52	YC59
						5.5nF	7.6nF	10.8nF	15.8nF	15.8nF	33.8nF	180.8nF	220.8nF
	ZB05	0.2				YP10	YP17	YP24	YP31	YP31	YP45	YP52	YP59
						6.3nF	8.4nF	11.6nF	16.6nF	16.6nF	34.6nF	181.6nF	221.6nF
9	ZA09	0.1				YC11	YC18	YC25	YC32	YC39	YC46	YC53	YC60
						5.3nF	7.4nF	10.6nF	15.6nF	22.6nF	33.6nF	180.6nF	220.6nF
	ZB09	0.2				YP11	YP18	YP25	YP32	YP39	YP46	YP53	YP60
						5.9nF	8nF	11.2nF	16.2nF	23.2nF	34.2nF	181.2nF	221.2nF
14	ZA14	0.1			YC05	YC12	YC19	YC26	YC33	YC40	YC47	YC54	YC61
					2.2nF	5.1nF	7.2nF	10.4nF	15.4nF	22.4nF	33.4nF	180.4nF	220.4nF
	ZB14	0.2			YP05	YP12	YP19	YP26	YP33	YP40	YP47	YP54	YP61
					2.6nF	5.5nF	7.6nF	10.8nF	15.8nF	22.8nF	33.8nF	180.8nF	220.8nF
18	ZA18	0.1			YC06	YC13	YC20	YC27	YC34	YC41	YC48	YC55	YC62
					2nF	4.9nF	7nF	10.2nF	15.2nF	22.2nF	33.2nF	180.2nF	220.2nF
	ZB18	0.2			YP06	YP13	YP20	YP27	YP34	YP41	YP48	YP55	YP62
					2.2nF	5.1nF	7.2nF	10.4nF	15.4nF	22.4nF	33.4nF	180.4nF	220.4nF
26	ZA26	0.1	YC01	YC03	YC07	YC14	YC21	YC28	YC35	YC42	YC49	YC56	YC63
			620pF	1.15nF	1.95nF	4.85nF	6.95nF	10.15nF	15.15nF	22.15nF	33.15nF	180.15nF	220.15nF
	ZB26	0.2	YP01	YP03	YP07	YP14	YP21	YP28	YP35	YP42	YP49	YP56	YP63
			770pF	1.3nF	2.1nF	5nF	7.1nF	10.3nF	15.3nF	22.3nF	33.3nF	180.3nF	220.3nF
30	ZA30	0.1	YC02	YC04	YC08	YC15	YC22	YC29	YC36	YC43	YC50	YC57	YC64
			620pF	1.15nF	1.95nF	4.85nF	6.95nF	10.15nF	15.15nF	22.15nF	33.15nF	180.15nF	220.15nF
	ZB30	0.2	YP02	YP04	YP08	YP15	YP22	YP29	YP36	YP43	YP50	YP57	YP64
			770pF	1.3nF	2.1nF	5nF	7.1nF	10.3nF	15.3nF	22.3nF	33.3nF	180.3nF	220.3nF

- (1) Refer to the attenuation on pages 48-52.
- (2) Refer to the applicability on pages 15, 24, 33 and to the characteristics on page 63.

Example:

Assuming that a LC46 filter and a ZA14 transient protection are selected for all the connector contacts, the combined code can be extracted by finding the intersection of the LC46 column with the ZA14 row. The combined code is YC19. The typical capacitance of the combined filter is 7.2nF.

Refer to the design notes (page 92) for estimation of the cutoff frequency (f_{cc}) of the combined filter. If the estimated f_{cc} is too low, select a filter with lower capacitance.

Codes for homogenous CL Filter combined with Bidirectional Varistors

			Filter Code ¹										
			Cap.										
Working Voltage [VDC]	Transient Protection Code ²	Energy [J]	CL28	CL32	CL36	CL43	CL46	CL49	CL52	CL63	CL66	CL73	CL75
			470pF	1nF	1.8nF	4.7nF	6.8nF	10nF	15nF	22nF	33nF	180nF	220nF
3.3	ZA03	0.1				YD09 6.2nF	YD16 8.3nF	YD23 11.5nF	YD30 16.5nF	YD37 23.5nF	YD44 34.5nF	YD51 181.5nF	YD58 221.5nF
	ZB03	0.2				YR09 7.7nF	YR16 9.8nF	YR23 13nF	YR30 18nF	YR37 25nF	YR44 36nF	YR51 183nF	YR58 223nF
	ZC03	0.3								YI19 27nF	YI24 38nF	YI29 185nF	YI34 225nF
	ZF03	0.6								YT19 32nF	YT24 43nF	YT29 190nF	YT34 230nF
5.6	ZA05	0.1				YD10 5.5nF	YD17 7.6nF	YD24 10.8nF	YD31 15.8nF	YD38 22.8nF	YD45 33.8nF	YD52 180.8nF	YD59 220.8nF
	ZB05	0.2				YR10 6.3nF	YR17 8.4nF	YR24 11.6nF	YR31 16.6nF	YR38 23.6nF	YR45 34.6nF	YR52 181.6nF	YR59 221.6nF
	ZC05	0.3								YI20 25nF	YI25 36nF	YI30 183nF	YI35 223nF
	ZF05	0.6								YT20 28nF	YT25 39nF	YT30 186nF	YT35 226nF
9	ZA09	0.1				YD11 5.3nF	YD18 7.4nF	YD25 10.6nF	YD32 15.6nF	YD39 22.6nF	YD46 33.6nF	YD53 180.6nF	YD60 220.6nF
	ZB09	0.2				YR11 5.9nF	YR18 8nF	YR25 11.2nF	YR32 16.2nF	YR39 23.2nF	YR46 34.2nF	YR53 181.2nF	YR60 221.2nF
14	ZA14	0.1			YD05 2.2nF	YD12 5.1nF	YD19 7.2nF	YD26 10.4nF	YD33 15.4nF	YD40 22.4nF	YD47 33.4nF	YD54 180.4nF	YD61 220.4nF
	ZB14	0.2			YR05 2.6nF	YR12 5.5nF	YR19 7.6nF	YR26 10.8nF	YR33 15.8nF	YR40 22.8nF	YR47 33.8nF	YR54 180.8nF	YR61 220.8nF
	ZC14	0.3				YI04 5.6nF	YI07 7.7nF	YI11 10.9nF	YI16 15.9nF	YI21 22.9nF	YI26 33.9nF	YI31 180.9nF	YI36 220.9nF
	ZF14	0.6				YT04 6.5nF	YT07 8.6nF	YT11 11.8nF	YT16 16.8nF	YT21 23.8nF	YT26 34.8nF	YT31 181.8nF	YT36 221.8nF
18	ZA18	0.1			YD06 2nF	YD13 4.9nF	YD20 7nF	YD27 10.2nF	YD34 15.2nF	YD41 22.2nF	YD48 33.2nF	YD55 180.2nF	YD62 220.2nF
	ZB18	0.2			YR06 2.2nF	YR13 5.1nF	YR20 7.2nF	YR27 10.4nF	YR34 15.4nF	YR41 22.4nF	YR48 33.4nF	YR55 180.4nF	YR62 220.4nF
	ZC18	0.3			YI02 2.4nF	YI05 5.3nF	YI08 7.4nF	YI12 10.6nF	YI17 15.6nF	YI22 22.6nF	YI27 33.6nF	YI32 180.6nF	YI37 220.6nF
	ZF18	0.6			YT02 3nF	YT05 5.9nF	YT08 8nF	YT12 11.2nF	YT17 16.2nF	YT22 23.2nF	YT27 34.2nF	YT32 181.2nF	YT37 221.2nF
26	ZA26	0.1	YD01 620pF	YD03 1.15nF	YD07 1.95nF	YD14 4.85nF	YD21 6.95nF	YD28 10.15nF	YD35 15.15nF	YD42 22.15nF	YD49 33.15nF	YD56 180.15nF	YD63 220.15nF
	ZB26	0.2	YR01 770pF	YR03 1.3nF	YR07 2.1nF	YR14 5nF	YR21 7.1nF	YR28 10.3nF	YR35 15.3nF	YR42 22.3nF	YR49 33.3nF	YR56 180.3nF	YR63 220.3nF
	ZC26	0.3		YI01 1.25nF	YI03 2.05nF	YI06 4.95nF	YI09 7.05nF	YI13 10.25nF	YI18 15.25nF	YI23 22.25nF	YI28 33.25nF	YI33 180.25nF	YI38 220.25nF
	ZF26	0.6		YT01 1.5nF	YT03 2.3nF	YT06 5.2nF	YT09 7.3nF	YT13 10.5nF	YT18 15.5nF	YT23 22.5nF	YT28 33.5nF	YT33 180.5nF	YT38 220.5nF
30	ZA30	0.1	YD02 620pF	YD04 1.15nF	YD08 1.95nF	YD15 4.85nF	YD22 6.95nF	YD29 10.15nF	YD36 15.15nF	YD43 22.15nF	YD50 33.15nF	YD57 180.15nF	YD64 220.15nF
	ZB30	0.2	YR02 770pF	YR04 1.3nF	YR08 2.1nF	YR15 5nF	YR22 7.1nF	YR29 10.3nF	YR36 15.3nF	YR43 22.3nF	YR50 33.3nF	YR57 180.3nF	YR64 220.3nF

Filter & Transient Protection

- (1) Refer to the attenuation on pages 48-52.
- (2) Refer to the applicability on pages 15, 24, 33 and to the characteristics on page 63.

Example:

Assuming that a CL46 filter and a ZA14 transient protection are selected for all the connector contacts, the combined code can be extracted by finding the intersection of the CL46 **column** with the ZA14 **row**. The combined code is YD19. The typical capacitance of the combined filter is **7.2nF**.

Refer to the design notes (page 92) for estimation of the cutoff frequency (f_{co}) of the combined filter. If the estimated f_{co} is too low, select a filter with lower capacitance.

Codes for homogenous Pi Filter combined with Bidirectional Varistors

Working Voltage [VDC]	Transient Protection Code ²	Energy [J]	Filter Code ¹													
			Cap.													
			PP28	PP32	PP36	PP43	PP46	PP49	PP52	PP55	PP62	PP65	PP68	PP71	PP80	
440pF	940pF	2nF	3nF	4.4nF	9.4nF	13.6nF	19.7nF	24nF	44nF	66nF	94nF	440nF				
3.3	ZA03	0.1					YE13 5.9nF	YE20 10.9nF	YE27 15.1nF	YE34 21.2nF	YE34 21.2nF	YE48 45.5nF	YE55 67.5nF	YE62 95.5nF	YE69 221.5nF	
	ZC03	0.3									YJ23 29nF	YJ28 49nF	YJ33 71nF	YJ38 99nF	YJ43 225nF	
5.6	ZA05	0.1					YE14 5.2nF	YE21 10.2nF	YE28 14.4nF	YE35 20.5nF	YE42 24.8nF	YE49 44.8nF	YE56 66.8nF	YE63 94.8nF	YE70 220.8nF	
	ZC05	0.3						YJ10 12.4nF	YJ14 16.6nF	YJ19 22.7nF	YJ24 27nF	YJ29 47nF	YJ34 69nF	YJ39 97nF	YJ44 223nF	
9	ZA09	0.1			YE08 3.6nF	YE15 5nF	YE22 10nF	YE29 14.2nF	YE36 20.3nF	YE43 24.6nF	YE50 44.6nF	YE57 66.6nF	YE64 94.6nF	YE71 220.6nF		
14	ZA14	0.1		YE04 2.4nF	YE09 3.4nF	YE16 4.8nF	YE23 9.8nF	YE30 14nF	YE37 20.1nF	YE44 24.4nF	YE51 44.4nF	YE58 66.4nF	YE65 94.4nF	YE72 220.4nF		
	ZC14	0.3		YJ04 3.9nF	YJ07 5.3nF	YJ11 10.3nF	YJ15 14.5nF	YJ20 20.6nF	YJ25 24.9nF	YJ30 44.9nF	YJ35 66.9nF	YJ40 94.9nF	YJ45 220.9nF			
18	ZA18	0.1		YE05 2.2nF	YE10 3.2nF	YE17 4.6nF	YE24 9.6nF	YE31 13.8nF	YE38 19.9nF	YE45 24.2nF	YE52 44.2nF	YE59 66.2nF	YE66 94.2nF	7366 220.2nF		
	ZC18	0.3		YJ02 2.6nF	YJ05 3.6nF	YJ08 5nF	YJ12 10nF	YJ16 14.2nF	YJ21 20.3nF	YJ26 24.6nF	YJ31 44.6nF	YJ36 66.6nF	YJ41 94.6nF	YJ45 220.6nF		
26	ZA26	0.1		YE02 1.09nF	YE06 2.15nF	YE11 3.15nF	YE18 4.55nF	YE25 9.55nF	YE32 13.75nF	YE39 19.85nF	YE46 24.15nF	YE53 44.15nF	YE60 66.15nF	YE67 94.15nF	YE74 220.15nF	
	ZC26	0.3		YJ01 1.19nF	YJ03 2.25nF	YJ06 2.25nF	YJ09 4.65nF	YJ13 9.65nF	YJ17 13.85nF	YJ22 19.95nF	YJ27 24.25nF	YJ32 44.25nF	YJ37 66.25nF	YJ42 94.25nF	YJ47 220.25nF	
30	ZA30	0.1	YE01 590pF	YE03 1.09nF	YE07 2.15nF	YE12 3.15nF	YE19 4.55nF	YE26 9.55nF	YE33 13.75nF	YE40 19.85nF	YE47 24.15nF	YE54 44.15nF	YE61 66.15nF	YE68 94.15nF	YE75 220.15nF	

- (1) Refer to the attenuation on pages 53-57.
- (2) Refer to the applicability on pages 15, 24, 33 and to the characteristics on page 63.

Example:

Assuming that a PP46 filter and a ZA14 transient protection are selected for all the connector contacts, the combined code can be extracted by finding the intersection of the PP46 column with the ZA14 row. The combined code is YE16. The typical capacitance of the combined filter is 4.8nF.

Refer to the design notes (page 92) for estimation of the cutoff frequency (f_{ce}) of the combined filter. If the estimated f_{ce} is too low, select a filter with lower capacitance.

Other Filter Families

- Audio / MIL-DTL-55116
- Arinc 600
- Arinc 404 / DPX
- DPK / MIL-DTL-83733
- Filter Array
- Feed Through Line Filters
- D-Sub Connectors

Selected Customized Products

- High attenuation filter from 1kHz up to 1GHz
- Very Low Frequency Filter with low profile extension
- Filter & Lightning protected connector
- Avionic Power Source of 115Vac / 400Hz Filtered connector
- Push-Pull LEMO filtered connector
- Filtered Standoff connector
- Cable assembly
- Hermetically Sealed and Filtered D-Sub connector
- Military RJ45 Connector for Ethernet
- RD1 Filtered connector
- Crimp termination filter connector
- D38999 Series III Filter Adaptor

Military AC Connectors

Military Fast Communication Connectors

Design Notes

- Brief introduction to EMC
- EMI Standards
- Selecting Filter topology
- Estimation of Filter Cut Off Frequency
- About Filter performance measuring methods
- Filter performance in non 50Ω system
- Circular Filter Connectors Check List



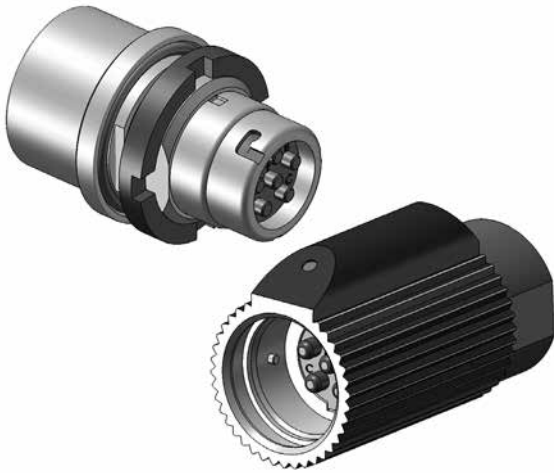

The filtered Audio connectors are identical to MIL-DTL-55116 connectors in the mechanical characteristics of the mating side, material, finish and their capability to withstand harsh environmental conditions.

These connectors are available with 5 or 6 contacts, Receptacles (Long or Short shell style) and Plugs.

The filtered Audio connectors are available with C filter, Pi Filter, with or without grounded contact A. The filters are available with standard performance (as shown in the Attenuation table) or high performance per request.

Additional and non-standard filter types are also available.

The Miniature Audio Connectors VBA series, that meets the VG95351 and VG96934 standards, with 7 and 10 contacts are also available.

Material & Finish

Part	Material & Finish	Part	Material & Finish
Connector Shell and Panel Nut	Stainless Steel (type 303), Passivated and Sand Blasted or Black Nylon overmolded (Plugs)	Contacts	Copper alloy, Gold plate 0.76 µm (30 µInch) Min. over Electroless Nickel
Insulator	Diallyl Phthalate blue	Contacts Termination:	
		PCB tail	Copper Alloy, Flash Gold plated
		Solder Cup	Copper alloy, Tin plated

Environmental and Mechanical Specifications

Parameter	Characteristics	Parameter	Characteristics
Water Immersion	48 hours at 2m of water	Air Pressure	2.5 P.S.I.
Operating Temperature	-55°C to +85°C	Durability	3000 cycles

Mechanical Dimensions

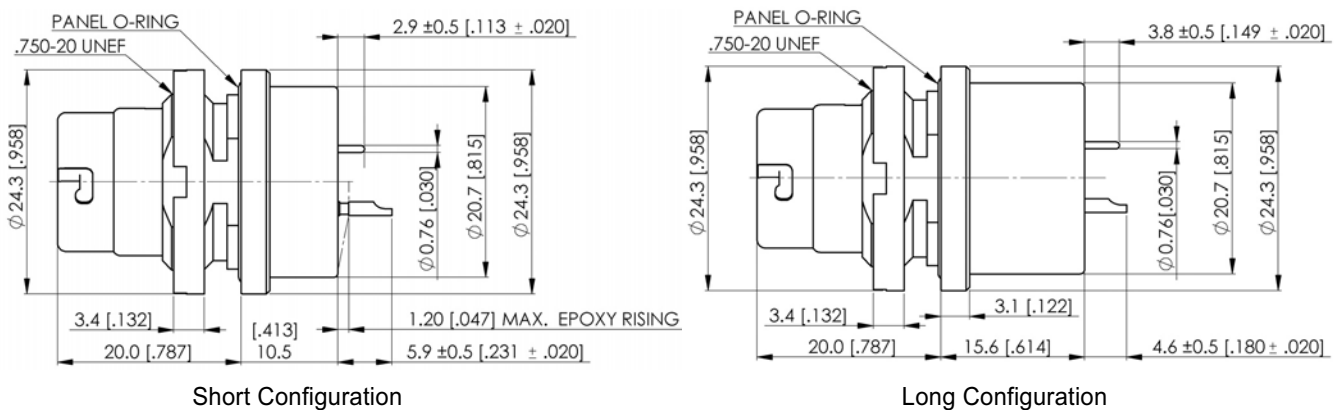

Insert Arrangements (Recept. Front view)

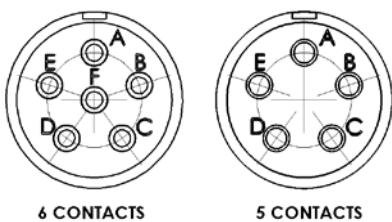

Panel Cutout

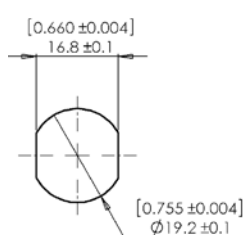

Board Drilling

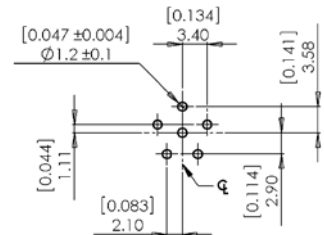

* Dimensions are in Millimeters. Values in brackets are Inches equivalents.
* Dimensions subject to change without prior notice.

How To Order

AC S 6 1 PA 49

AUDIO CONNECTOR

SHELL STYLE
 S- Short
 L- Long
 P- Plug (non-jacketed body, round)
 Q- Plug (black Nylon-jacketed body, with lever button)

No. OF CONTACTS
 5- 5 Contacts
 6- 6 Contacts

TERMINATION STYLE
 1- Solder Cup
 2- PCB Tin Plated
 4- PCB Gold Plated (Default)
 9- Special

FILTER TYPE
 CC - All contacts are C filtered
 CA - Contact A grounded, All other contacts are C filtered
 PP - All contacts are Pi filtered
 PA - Contact A grounded, All other contacts are Pi filtered
 XX - Special

CAPACITANCE PER FILTER CODES (see table below)
 XX - Special

Audio MIL-DTL-55116

Filter Electrical Characteristics

Contact Current Rating	=	3A
Working Voltage	=	200VDC
Dielectric withstanding Voltage	=	500VDC
Min. Insulation Resistance	=	1GΩ
Max. Contact Resistance	=	5mΩ

Minimum Attenuation

Filter	Shell Style	Filter Code (2)	Cap. ±20% [nF]	f _{co} [MHz] Typical (3)	Min. Attenuation [dB] vs. Frequency [MHz] (1)								
					1	5	10	30	50	100	300	500	1000
C	Short & Long	39	1	8	0	0	2	11	18	31	47	39	31
		42	2.2	3.2	0	3	8	19	27	43	46	41	33
		54	4.7	1.6	0	8	14	26	34	54	46	41	35
		58	6.8	0.95	1	12	18	31	39	50	47	43	37
		62	10	0.665	3	15	21	34	46	46	46	41	34
		72	33	0.182	11	25	32	55	46	42	45	42	34
Pi	Short	32	0.94	6.5	0	0	3	14	23	37	77	68	51
		47	3	2.4	0	5	11	30	43	64	65	62	50
		46	4.4	1.6	0	8	15	38	51	77	65	63	54
		48	7.8	0.8	1	14	26	50	67	87	65	64	53
		49	9.4	0.84	1	13	25	49	65	78	65	68	56
	55	20	0.3	7	26	40	69	89	76	67	64	57	
	Long	32	0.94	2.8	0	3	7	20	31	45	75	72	53
		43	3	1.8	0	10	20	40	52	70	64	65	51
		46	4.4	1.6	0	15	27	48	59	80	66	65	57
		48	7.8	0.8	1	25	38	73	73	81	65	66	54
49		9.4	0.84	1	26	40	61	76	82	65	65	55	
55	20	0.35	5	40	54	74	97	78	65	68	57		

(1) Measured in 50Ω system according to MIL-STD -220, no load. For other higher performance, contact sales.
 (2) For other filter options, working voltage or capacitance values use XXXX suffix and contact sales.
 (3) For estimation of the filter cut off frequency in non-50Ω system please refer to the design notes (page 92).

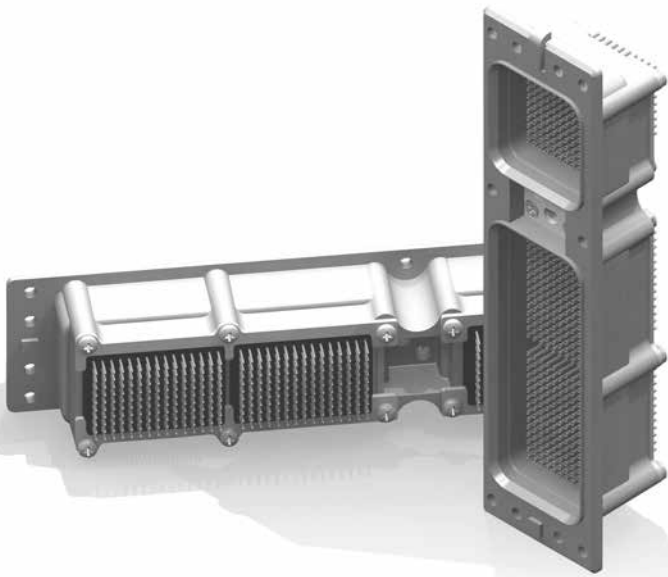

The Arinc 600 Rack & Panel connector series are mainly used in Avionic applications.

Available in both environmental resistant and non-resistant versions and has special low insertion force contacts.

These connectors use Signal and Power contacts of sizes #8, #12, #16, #20, #22 and Coaxial contacts of sizes #1, #5, #8. Triax and Twinax contacts are also available.

The Arinc 600 connectors are available in 3 sizes:

Size 1 - with 3 low profile contact cavities, Size 2 - with 3 wide profile contact cavities and Size 3 - with 6 wide profile contact cavities. The maximum quantity of size #22 contacts is 800.

Each cavity has its own characters in manners of contact arrangement and signal description. Homogenous or selective filters and transient protection can be applied to meet customer specifications.

Compliance with RTCA-DO/160 requirements is available.

Size 1

ARINC 600

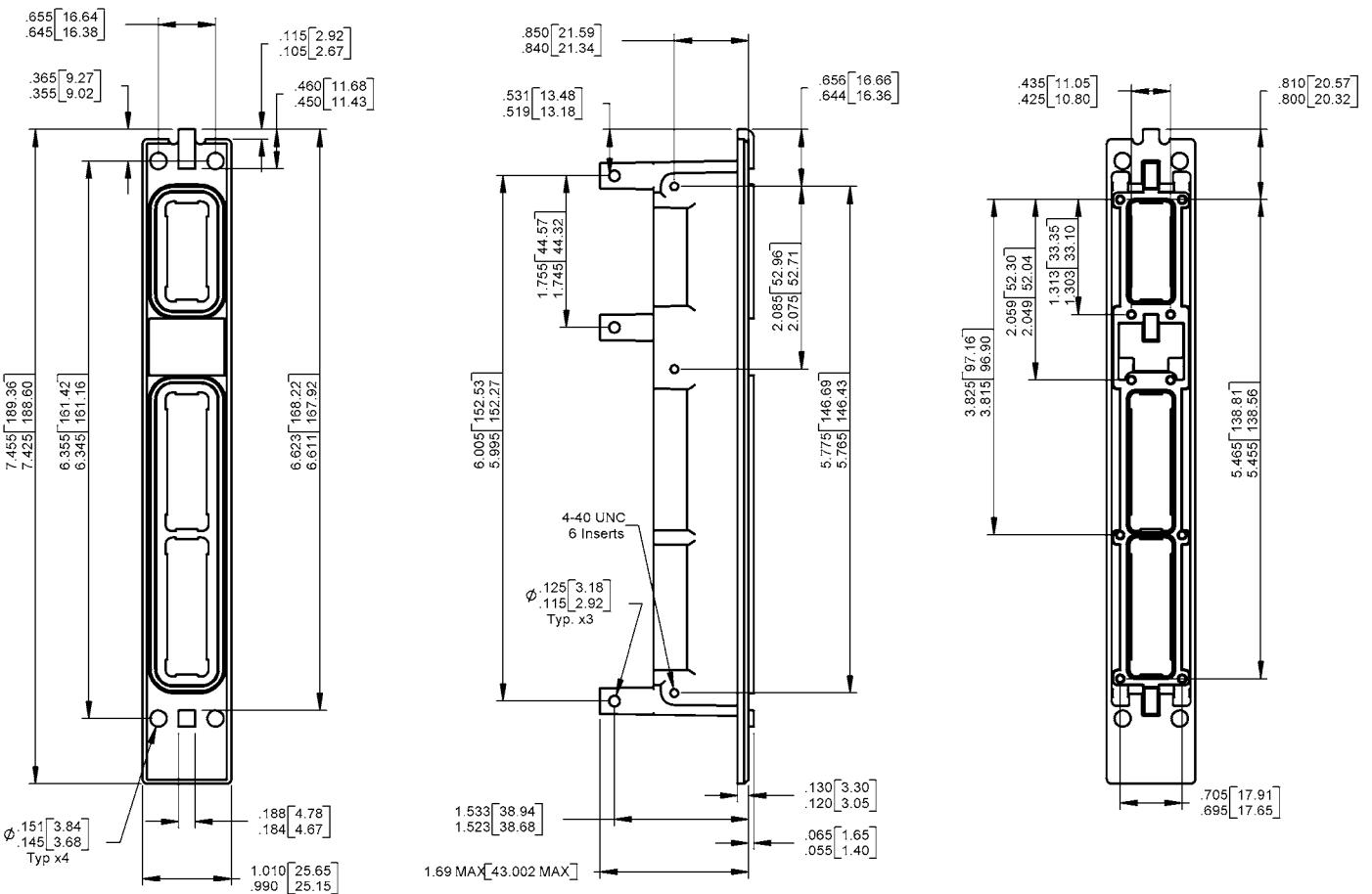

Size 2

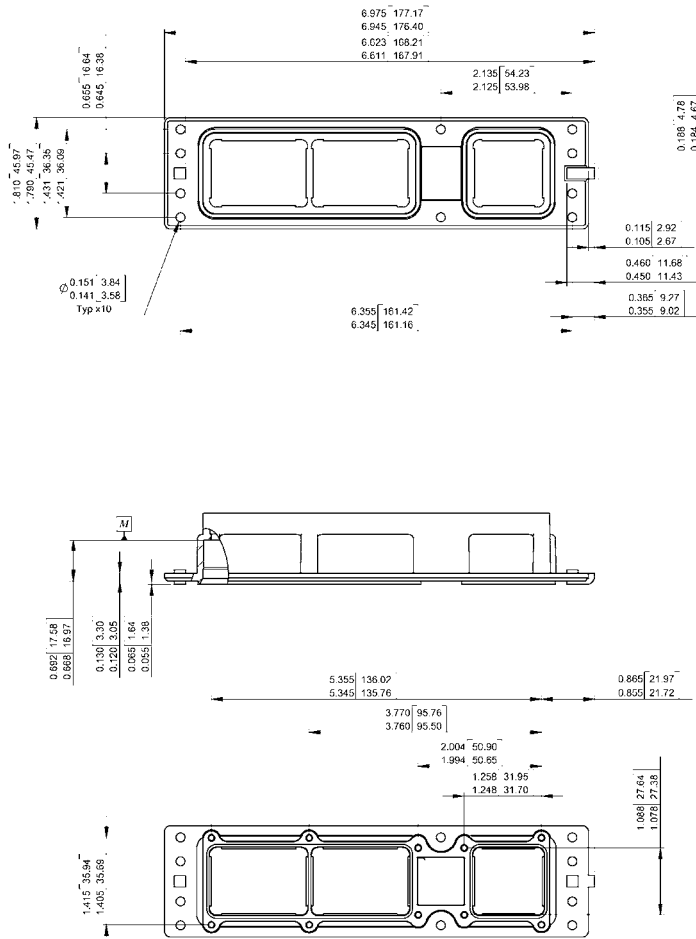

Size 3

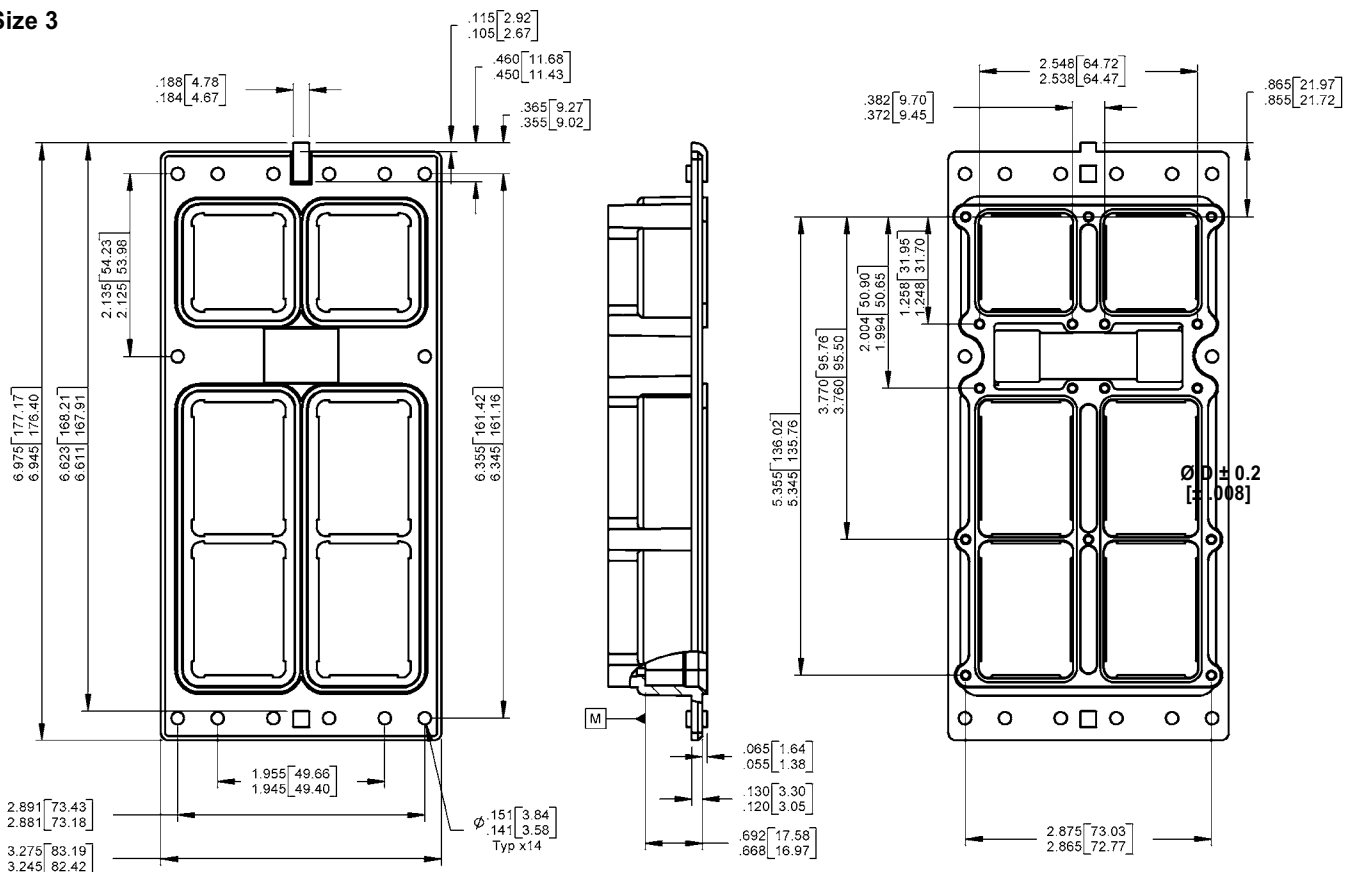

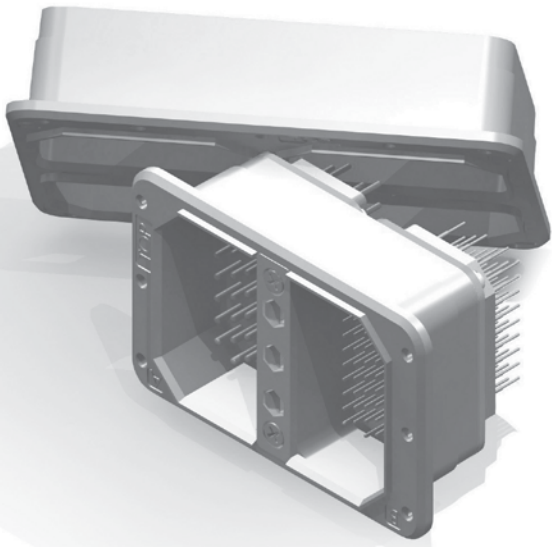

The Arinc 404 / DPX series are one piece shell miniature Rack & Panel connectors that are mainly used for Avionic applications. Available in both environmental resistant and non-resistant versions and in one, two, three and four Gang (contact cavities) versions in Arinc 404 standard shells.

The shells are keystone shaped with 3 hexagonal polarization posts that provide up to 99 unique polarization positions.

These connectors use Signal and Power contacts of sizes #4, #8, #12, #16, #20, #22 and Coaxial contacts of sizes #5, #9, #11.

Each cavity has its own characters in manners of contact arrangement and signal description. Homogenous or selective filters and transient protection can be applied to meet customer specifications.

Compliance with RTCA-DO/160 requirements is available.

Single Gang Series

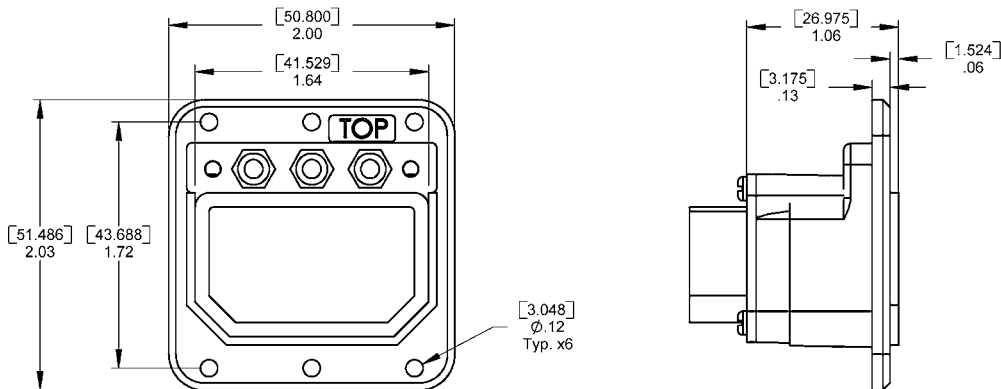

ARINC 404 / DPX
MIL DTL - 81659

Two Gang Series

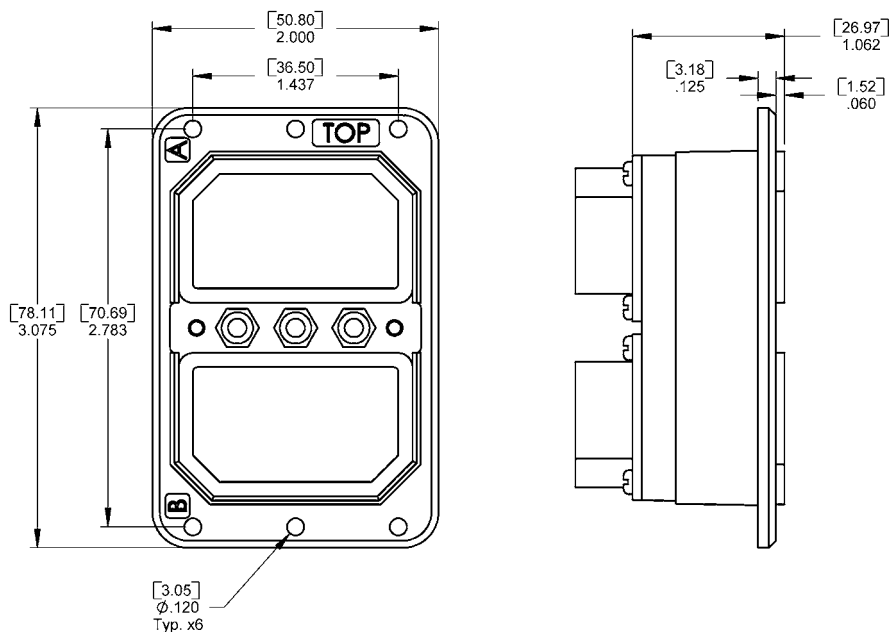

Three Gang Series

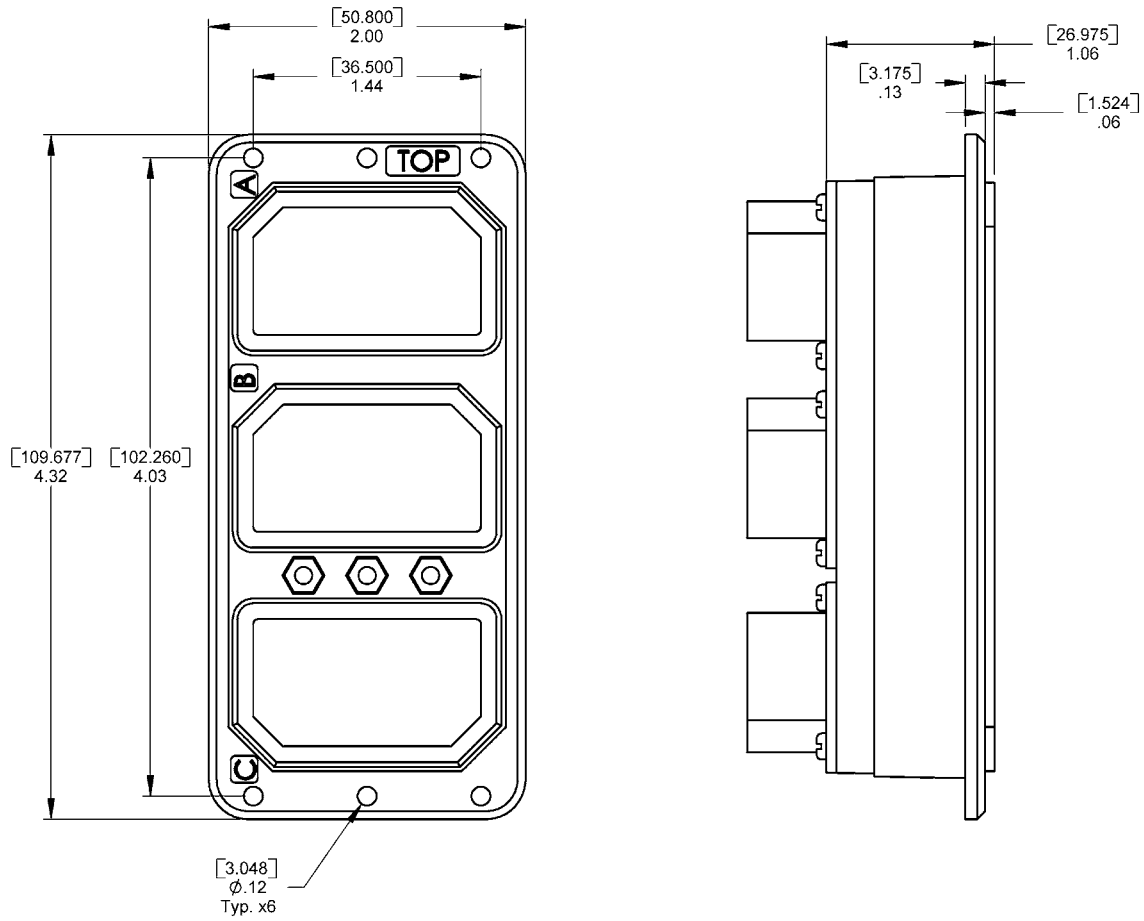

Four Gang Series

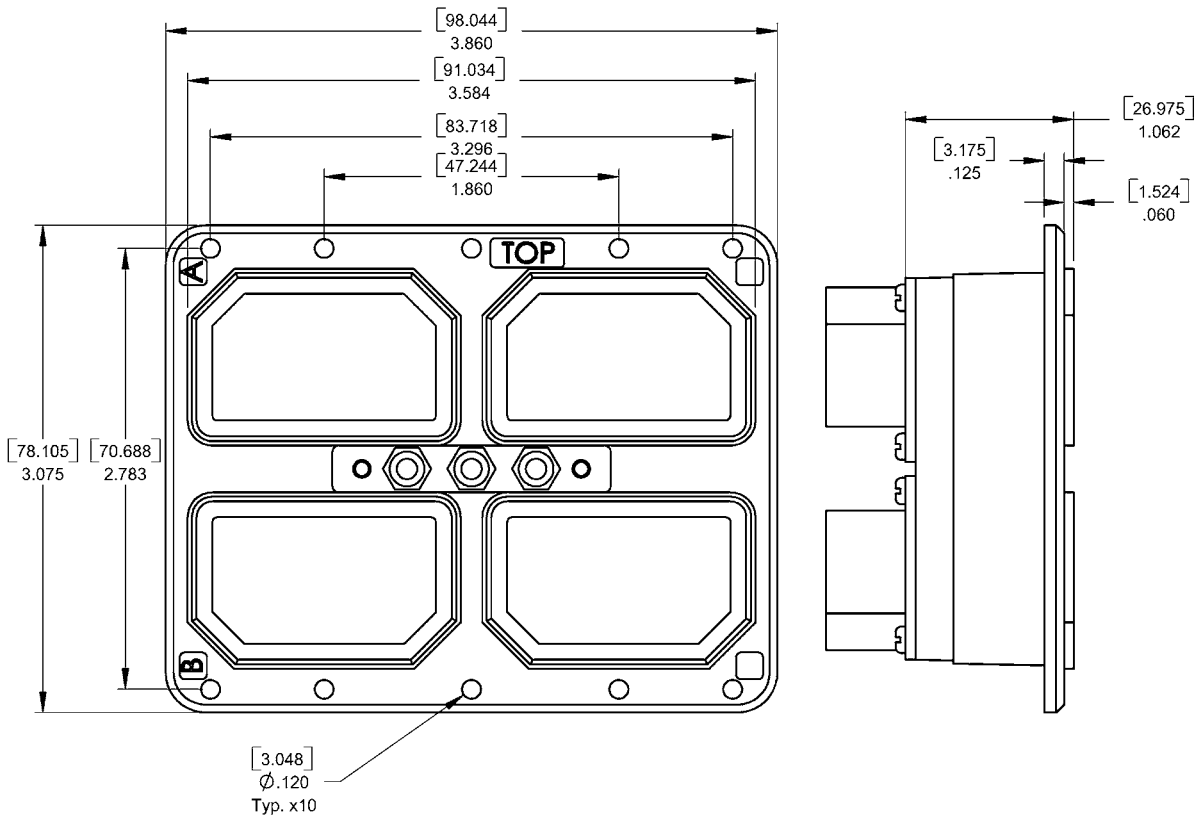

ARINC 404 / DPX
MIL DT4 - 81659



The DPK series rectangular connectors feature high performance environmental resistant and are mainly used for Avionic applications. Available in two shell sizes with a variety of mounting configurations.

These connectors use contacts of sizes #12, #16, #20, #22D. There are 13 contact arrangements available accommodating from 18 to 185 size #22 contacts.

Homogenous or selective filters and transient protection can be applied to meet customer specifications. Compliance with RTCA-DO/160 requirements is available.

MIL-DTL-83733 / DPK

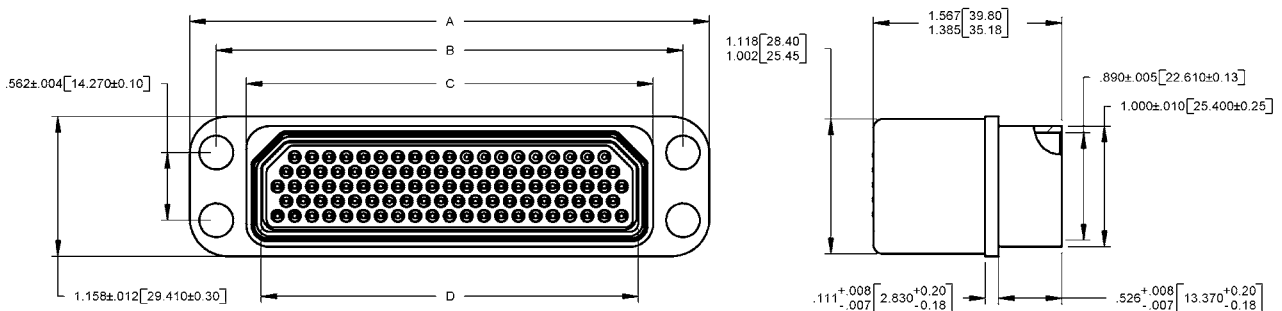

Shell Size	A Max	B Max	C Max	D ± 0.2 [± .008]
DPKA	.979 [24.87]	.596/.590 [15.14/14.99]	.829 [21.06]	.625 [15.88]
DPKB	1.104 [28.05]	.721/.715 [18.03/18.16]	.954 [24.24]	.750 [19.05]

Filter Array

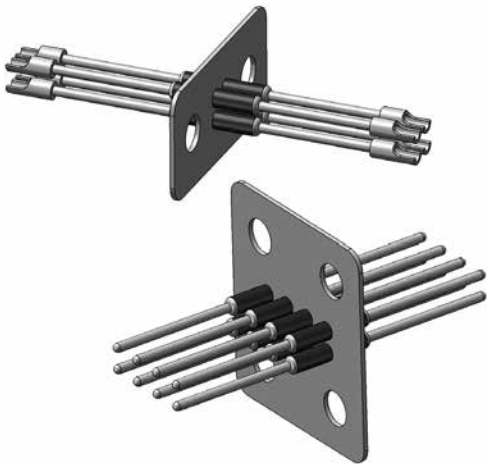

Filter Array, an array of C or Pi Feed-Through filters assembled on metal plate, is a low-cost efficient solution for EMI/RFI problems.

The Filter Array provides EMI protection for signal lines with the applicability to integrate different capacitances. RF Immunity provides standard as well as fully customized Filter Array, while utilizing various filtering topologies and levels on dimensionally customized metal plate.

The connection can be made either by using suitable headers or direct wiring of Feed-Through contacts to allow easy installation so as to pass on reduced costs in comparison with discrete filters.

Feed Through Line Filters

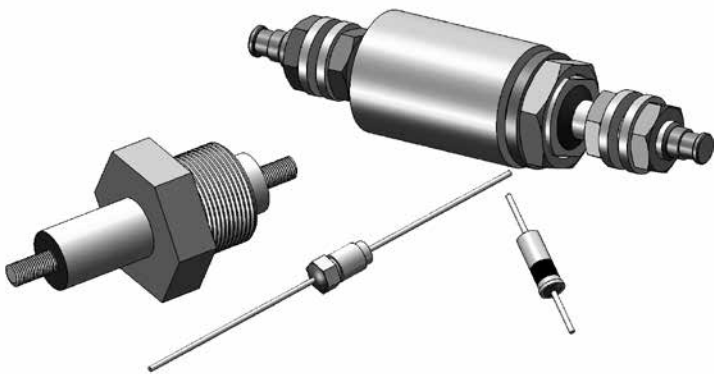

RF Immunity offers a vast variety of Feed-Through Filter line for commercial and military applications. Military and Customized Feed-Through Filter Line is produced to meet most stringent customer's specifications - mechanical, electrical and environmental requirements. This product line can meet few hundreds amperes and few thousand volts requirements as well as various standards such as MIL-STD-28861, MIL-STD-15733, MIL-STD-202 and others. The products can be provided with C, L, PI and T filter topologies and resin or hermetic glass sealing. We can also offer Bolt-In Feed-Through Filter line to be panel installed. The Bolt-In family range supports both signal and power lines - DC and AC - with current of up to hundreds Amperes and DC voltage of up to thousands Volts.

D-Sub Connectors



The D-Sub filtered connectors family features D-Sub STD density, High density, Combo and MDM connectors. We offer standard as well as custom design configurations in form of sealed or special shell design connectors for extreme environmental conditions.

The D-Sub product line also includes adaptors in a variety of sizes and configurations. Our filtering solutions for these families are provided in form of C, L, CL, LC and Pi filters and can also contain transient protection all enclosed in the standard shell dimensions.

Please refer to our D-Sub catalog for more information.

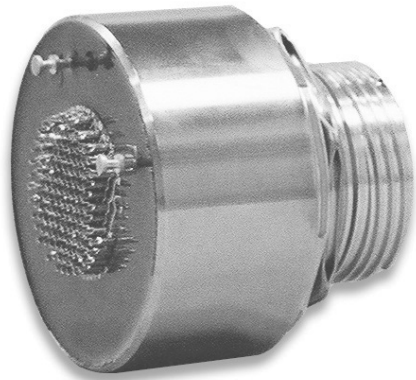

Filter connector for Missile application

Based on D38999 Jam Nut connector with a custom back extension. A power line filter and a signal line filter are enclosed in its housing with a high attenuation filter from 1kHz up to 1GHz

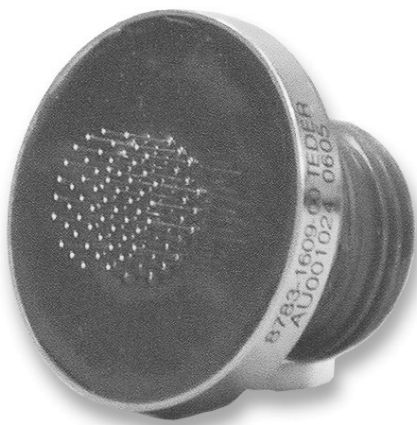

Very Low Frequency Filter with low profile extension for ground mobile application

Based on D38999 Jam Nut connector with a custom low profile back extension. It contains 28V/12A power line filter, double L section filter with $F_{co}=6\text{kHz}$ and a diversity of additional signal filters.



Filtered & Lightning protected connector for HUD application

Designed to meet MIL-STD-461 and RTCA/DO-160E Section 22 standards, the filtered & lightning protected 100 pin, D38999 circular military connector was designated for HUD (Head Up Displays).

The filtering topology includes 3 capacitance levels, according to the customer's pin out requirements. To accommodate the filtering together with the lightning protection array, a unique square shaped extension was designed to be attached to the rear of the connector.

Avionic Power Source of 115Vac / 400Hz Filtered Connector



Based on D38999/20WE06PN, the connector was designed for filtering and providing attenuation of 20dB from 10 kHz and 60dB from 100 kHz on the Power Leads of Avionic equipment. The filter has Pi filter topology combined with Common Mode Choke and withstands working voltages of 1000Vdc & DWV of 1250Vdc.

The filtered connector complies with the environmental requirements of avionic applications, meaning, vibrations, altitude and pressure. Due to space limitations, the termination is a side mounted PCB with soldering holes. This provides a flat back of the connector and saves the space.

In addition, the connector has a unique excentric structure of the back side which is shifted compared to mating side due to customer's panel design.

19 contacts Push-Pull LEMO filtered connector for military communication units



The Lemo 19 pin contacts is a push-pull miniature connector where only 3 out of 19 contacts were required to filter. Utilizing our advanced and innovative technology, RF Immunity successfully incorporated HI filter topology to tackle interferences in tactical frequency range of 670kHz - 100MHz to meet MIL-STD-461.

Another unique feature is the mechanical release of only 3 solder cups, out of 19, in the back part of the connector.

The mechanical shape & dimensions were maintained during the filtering process.

55 cont. Filtered Standoff Connector for Avionic applications



This specially designed filtered connector was developed for use in a highly sophisticated avionic laser system which was required to meet both MIL-STD-461 and strict requirements of RTCA-DO160.

The result is a filtered connector with rear thread interface for PCB mounting. Designed with diversified values of capacitances from 0.94nF to 20nF arranged in PI filter topology plus Common Mode Chokes and TVS units for lightning protection.

In addition, the connector is hermetically sealed per MIL standards.



Cable Assembly

As part of RF Immunity's added value and turnkey solutions in the filter connector field, the company offers cable assembly services. These services include: Design and validation, prototyping for customized cable assembly, full control and warranty over the complete wiring and harnesses with in-process testing to ensure the highest levels of reliability for strictly demanding military applications.



Filtered & Hermetically Sealed custom shaped D-Sub Connectors

The showcased connectors are custom made filtered D-Sub 9 pin contacts and 25 socket contacts with different filtering topologies. In addition to the filtering, the connectors were designed as hermetically sealed units to withstand military sealing standards as low as 10^{-5} cm³/sec Helium at $\Delta P=1$ atm. Developed to meet customer's requirements, a front groove was designed to house an O-Ring providing hermetic sealing against the mounted rear panel surface. Rear and front mount design configurations are applicable. The external mechanical configurations were designed to allow close mounting of the two connectors to meet space constraints on the panel.



MIL RJ45 Connector - Military Filter Connector for Ethernet & Data Lines

The MIL RJ45 Connector introduces the latest technology edge in filtering fast Ethernet protocols (10/100/1000 Base T lines) built to withstand harsh environmental conditions. Based on circular connector D38999 series III shell size 19 with integrated RJ45 mating side mechanism, the MIL RJ45 filtered connector incorporates magnetic and filter components fully intermatable with standard category 5 cables. Designed to maintain Ethernet signal integrity and significant Common Mode rejection at tactical frequency range of 2MHz-100MHz, the MIL RJ45 filtered connector complies with strict MIL environmental standards.

RD1 Aircraft power and data BUS Filter Connector

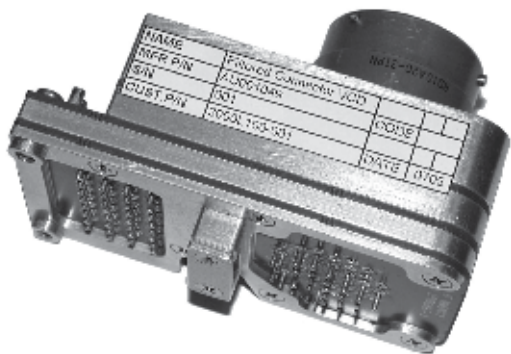

Being tailored for avionic applications, this custom made filter connector is based on a standard 31 pin circular connector able to accommodate any combination of 16 AWG Coax or Twinax contacts.

Retrofitted an existing non-filtered connector to preserve the system performance and mechanical characteristics, the connector's extended housing was designed to meet stringent EMC requirements and withstand avionic extreme environmental conditions.

This connector was designed to incorporate different filter topologies and characteristics for the following signal types: 1) 3 Phase 115VAC/400Hz power supply lines 2) High frequency differential RS422 lines 3) MUX BUS communication lines 4) Discrete lines. All signals were filtered through two filtering levels from PI section to CMC filtering.

In order to incorporate all incoming/outgoing signals, solder cups were designed on the outside surface of the mechanical rear extension.

Filter Connector with crimp termination



Based on MS27497 (D38999 series II), this crimp termination connector was developed in order to meet the request of well-known aircraft manufacturer for maintenance without the need of soldering on aircraft. The connector has extended rear side for accommodating the filter and crimp locking mechanism. The filter was designed to reduce EMI above 3kHz from audio circuits and to withstand lightning strikes per RTCA-DO/160 section 22, level 3. The connector successfully passed all environmental tests according to airborne equipment test procedure.

The crimp termination is available in all other families and series.

D38999 Series III Filter Adaptor



The filter Adaptor is produced for applications wherever adding filter connector is not possible (the equipment is in the field, in action or the connector cannot be unassembled).

This unique solution is also practical for EMC tests, integrations and evaluations.

The connector can integrate selective filtering characteristics for each contact or homogeneous/flat filtering for all contacts. The Adaptor is manufactured from Aluminium and plated with Olive Drab Cadmium. The shown products are Receptacle to Plug structure, but any configuration of style and filtering can be developed.

Since 2012 the D38999 Filter Adaptor is offered as an off the shelf product (see page 13).

Designed for AC (Alternating Current) power lines applications, the filtered MIL-VAC Connectors solve Electro Magnetic Compatibility problems experienced in electrical systems fed from aircrafts and shipboards power generators. RF Immunity's solution cover both CE (Conducted Emission) and RE (Radiated Emission), while offering a reliable protection from incoming interferences riding on power lines known as CS (Conducted Susceptibility).

Our AC connector portfolio presents the most common contact arrangements applicable for working voltage of 230VAC/50Hz, 115VAC/60Hz and 115VAC/400Hz, 1-phase or 3-phase applications with leakage current rate lower than 10mA.

This line of products comes with different mounting options, termination types and diversified mechanical characteristics.

The following products are based on MIL-DTL-38999. Other series and standard connector size are also available.

High to Ultra-High Frequency Pi Filter, up to 2000V_{DC}

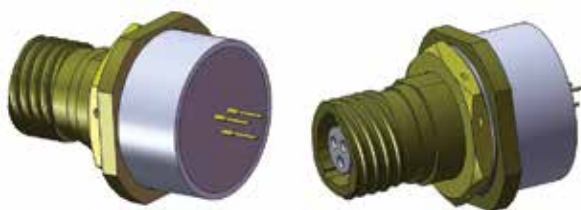

09-98
(3 #20)

Current Rating up to 7.5A

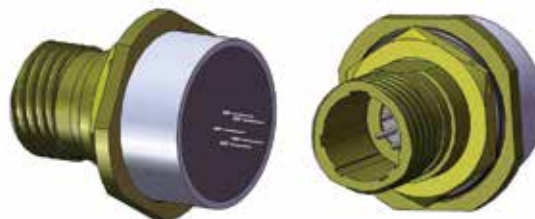

11-05
(5 #20)

Current Rating up to 7.5A

Very-Low to Ultra-High Frequency Pi Filter, up to 2000V_{DC}, Integrated Common Mode Choke.

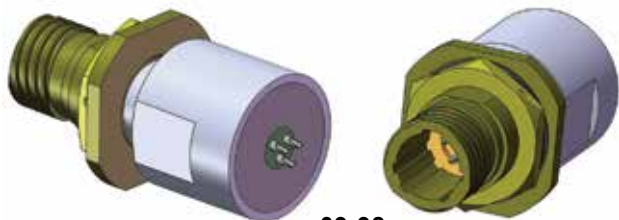

09-98
(3 #20)

Current Rating up to 7.5A



17-06
(6 #12)

Current Rating up to 23A

Very-Low to Ultra-High Frequency Pi Filter, up to 2000V_{DC}, Integrated Common Mode Choke, Cabling Accessories option.



13-04
(4 #16)

Current Rating up to 5A



13-04
(4 #16)

Current Rating up to 13A

*For more off-the-shelf arrangements of Military AC Connectors, contact sales.

Military Filter Connectors for Ethernet & Data Relay Applications

RF Immunity is proud to introduce its latest developments in the product line of military filter connector for Ethernet and fast communication protocols.

This objective achieved whilst meeting the array of requirements typical to this demanding market - namely the highest levels of built-in reliability, the ability to incorporate ever growing data rates with dense packaging options and light-weight products that must withstand the most rugged environments.

MIL-USB CONNECTORS

Based on circular connector D38999/A35 compatible with USB2.0 military application, MIL-USB connector is applicable wherever keyboards, flash memories and other devices are used under harsh environmental conditions. Developed to enable fast data rates as 480Mb/s for USB2.0, the MIL-USB filtered connector presents significant common mode attenuation at tactical frequency range of 2MHz-100MHz while maintaining full intermatability with mating side connector - D38999/26 - A35.

Available in different arrangements and terminations.



MIL-LAN CONNECTOR

Based on circular connector D38999/B35, the MIL-LAN connector designed as a military filter connector, featuring magnetic mechanism, for fast data rate of up to 1GHz (10/100/1000 Base T) applications. Designed to maintain Ethernet signal integrity and significant common mode rejection at tactical frequencies 2MHz-100MHz, the MIL-LAN filtered connector qualifies for strict military standards and reserves full intermatability with mating side plug connector - D38999/26-B35.

Available in different arrangements and terminations.



Brief Introduction to EMC

The concern of designers to product electromagnetic compatibility issues has dramatically increased in the recent years. Many different standards have been developed and released, and all electrical and electronics engineers are aware of different compatibility tests. Unfortunately, there are still a lot of designers that encounter difficulties when dealing with EMC, either with understanding the issue, or in solving the related problems.

So, what is EMC?

ElectroMagnetic Compatibility (EMC) is defined as the ability of a device or system to satisfactorily function (without errors) in the target electromagnetic environmental conditions.

Nowadays, various EMC standards define the permissible electromagnetic interaction between every system and its immediate environment. All electronic systems must be compatible to all other systems in the affected environment, in terms of EMC. This system compatibility must be proven by tests to be certified by the applicable EMC standard.

All these developments had lead to the emergence of a new engineering branch - the EMC engineering.

EMC engineering use analytical methods, design practices, test procedures, and solution hardware and components both to enable the system to function without errors in its target electromagnetic environment, and to prevent it from inflicting errors to any adjacent system. It also enables the system to meet the EMC control specifications limits.

EMC deals with 3 major components:

- The source of interference (noisy system or power supply), also called EMI source.
- The victim of interference (sensitive circuitry), also called EMI victim
- The coupling path.

EMI (Electromagnetic Interference) is defined as the electromagnetic emissions discharged by a device or a system that interfere with the normal operation of other devices or systems.

Electromagnetic compatibility problems are generally solved by identifying at least two of the above mentioned components and eliminating one of them.

Potential sources of electromagnetic compatibility problems include radio transmitters, power lines, electronic circuits, lightnings, lamp dimmers, electric motors, arc welders, solar flares and just about everything that utilizes or creates electromagnetic energy. Potential receptors include radio receivers, electronic circuits, appliances, people, and just about everything that utilizes or can detect electromagnetic energy. The way this electromagnetic energy is transferred from a source to a receptor fall into one of the following four categories.

1. Conductance (electric current)
2. Inductive coupling (magnetic field)
3. Capacitive coupling (electric field)
4. Radiation (electromagnetic field)

The coupling paths are often comprised of a complex combination of these routes, making the path difficult to be identified, even when the source and/or receptor are known. There may be multiple coupling paths, and steps taken to attenuate one may enhance another.

- Conducted noise is coupled between components through interconnecting wires such as power supply and ground lines. Common impedance coupling is caused when currents from two or more circuits flow through the same impedance such as power supply and ground lines.
- Radiated electromagnetic field coupling can be handled in one of the following ways: in the near field, E and H field couplings are handled separately. In the far field, the coupling is handled as a plane wave coupling.
- Electric field coupling is caused by the voltage difference between conductors. The coupling mechanism can be modeled by a capacitor.
- Magnetic field coupling is caused by the current flow in conductors. The coupling mechanism can be modeled by a transformer.

The most common methods used for noise reduction include proper circuit design, shielding, grounding, **filtering**, isolation, separation and orientation, circuit impedance match control, cable design, and other noise cancellation techniques.

RF Immunity gained extensive experience in developing and producing filter and transient protection connectors. We have a variety of off the shelf connectors similar in size to standard connectors, and we have the capacity to develop custom made filtering products that are fully compatible with the customer specifications and enable the customer system to be approved by compatibility tests.

EMI Standards

The requirements for control of EMI characteristics of systems and equipment are defined by specifications and standards.

The specifications and standards define the permissible interaction between the electromagnetic environment on the one hand, and systems and equipment on the other hand. Different standards are applied in different countries. US, European, British, Australian, Japanese and many other standards are in use in the corresponding countries, but they all fall into 2 major groups of EMI standards:

1. Military.
2. Commercial/Industrial.

Each group is divided into sub-groups, each of which deals with different types of equipment and environment: avionic, ground, navy, communications, etc.

The standard tests relate to 1 or both of the following major categories: conducted and radiated.

These 2 categories deal with emission and susceptibility interferences; it is presented as CE - for conducted emission, RE - for radiated emission, CS - conducted susceptibility and RS - for radiated susceptibility. Each section deals with different level of interference as well as different frequency range.

Here in are the details of a few well-known standards:

- A variety of commercial and industrial standards are in use, and in general, they are applicable to certain types of equipment. Few of these standards are listed in the following table.

Equipment	Standard	Description	Test
Household Appliances, Electric Tools and similar Aparatus	EN 55014-1	EMC: Emission	CE, RE
	EN 55014-2	EMC: Immunity	CS, RS
Information Technology Equipment	EN 55022	Radio Disturbance Characteristics - Limits and Methods of Measurement	CE, RE
	EN 55024	Immunity Characteristics - Limits and Methods of Measurement	CS, RS
Testing and Measurement Techniques	EN 61000-4-2	Electrostatic Discharge Requirements	ESD
	EN 61000-4-3	Radiated, RF, Electromagnetic Field Immunity	RS
	EN 61000-4-4	Electrical Fast Transient/Burst Immunity Test	Transient
	EN 61000-4-5	Surge Immunity Tests	Lightning
	EN 61000-4-6	Immunity to Conducted Disturbances, Induced by RF Fields	CS

- EUROCAE ED-14D/RTCA-DO-160D
ENVIROMENTAL CONDITIONS AND TEST PROCEDURES FOR AIRBORNE EQUIPMENT

EUROCAE ED-14D/RTCA-DO-160D ENVIROMENTAL CONDITIONS AND TEST PROCEDURES FOR AIRBORNE EQUIPMENT		
Section	Change	Description
17	-	Voltage Spikes
18	2	Audio Frequency Conducted Susceptibility Power Inputs
19	-	Induced Signal Susceptibility
20	1	Radio Frequency Susceptibility (Radiated and Conducted)
21	-	Emission of Radio Frequency Energy
22	3	Lightning Induced Transient Susceptibility
23	-	Lightning Direct Effects
25	-	Electrostatic Discharge

MIL-STD-461C + MIL-STD-462 Electromagnetic Emission and Susceptibility Requirements for the Control of Electromagnetic Interference			MIL-STD-461D + MIL-STD-462D MIL-STD-461E / F Requirements for the Control of Electromagnetic Interference Characteristics of Subsystems and Equipment				
MIL - STD - 461C			MIL-STD-461D / E / F		461D	461E	461F
Requirement	Description	Frequency	Requirement	Description	Frequency	Frequency	Frequency
CE01	Power and Interconnecting Leads	up to 15kHz	CE101	Power Leads	30Hz - 10kHz	30Hz - 10kHz	30Hz - 10kHz
CE03	Power and Interconnecting Leads	15 kHz- 50 MHz	CE102	Power Leads	10kHz - 10MHz	10kHz - 10MHz	10kHz - 10MHz
CE06	Antenna Terminals	10 kHz- 26 GHz	CE106	Antenna Terminal	10kHz - 40GHz	10kHz - 40GHz	10kHz - 40GHz
CE07	Power Leads, Spikes, Time Domain						
CS01	Power Leads	30 Hz- 50 kHz	CS101	Power Leads	30Hz - 50kHz	30Hz - 150kHz	30Hz - 150kHz
CS02	Power and Interconnecting Control Leads	50 kHz- 400 MHz					
CS03	Intermodulation	15 kHz- 10 GHz	CS103	Antenna Port, Intermodulation	15kHz - 10GHz	15kHz - 10GHz	15kHz - 10GHz
CS04	Rejection of Undesired Signals	30 Hz- 20 GHz	CS104	Antenna Port, Rejection of Undesired Signals	30Hz - 20GHz	30Hz - 20GHz	30Hz - 20GHz
CS05	Cross Modulation	30 Hz - 20 GHz	CS105	Antenna Port, Cross-Modulation	30Hz - 20GHz	30Hz - 20GHz	30Hz - 20GHz
CS06	Spikes, Power Leads		CS106	Transients, Power Leads			
CS07	Squelch Circuits						
CS09	Structure (Common Mode) Current	60 Hz- 100 kHz	CS109	Structure Current	60Hz - 100kHz	60Hz - 100kHz	60Hz - 100kHz
			CS114	Bulk Cable Injection	10kHz - 400MHz	10kHz - 200MHz	10kHz - 200MHz
			CS115	Bulk Cable Injection, Impulse Excitation			
CS10	Damped Sinusoidal Transients, Pins and Terminals	10 kHz- 100 MHz	CS116	Damp Sinusoidal Transients, Cables and Power Leads	10kHz - 100MHz	10kHz - 100MHz	10kHz - 100MHz
CS11	Damped Sinusoidal Transients, Cables	10 kHz- 100 MHz					
RE01	Magnetic Field	30 Hz- 50 kHz	RE101	Magnetic Field	30Hz - 100kHz	30Hz - 100kHz	30Hz - 100kHz
RE02	Electric Field	14 kHz- 10 GHz	RE102	Electric Field	10kHz - 18GHz	10kHz - 18GHz	10kHz - 18GHz
RE03	Spurious & Harmonics, Radiated Technique		RE103	Antenna Spurious and Harmonic Outputs	10kHz - 40GHz	10kHz - 40GHz	10kHz - 40GHz
RS01	Magnetic Field	30 Hz- 50 kHz	RS101	Magnetic Field	30Hz - 100kHz	30Hz - 100kHz	30Hz - 100kHz
RS02	Magnetic and Electric Fields						
RS03	Electric Field	14 kHz- 40 GHz	RS103	Electric Field	10kHz - 40GHz	10kHz - 40GHz	2MHz - 40GHz
RS05	Electromagnetic Pulse Field Transient		RS105	Transient Electromagnetic Field			

MIL-STD-461 Radiated Emission and Susceptibility Requirements

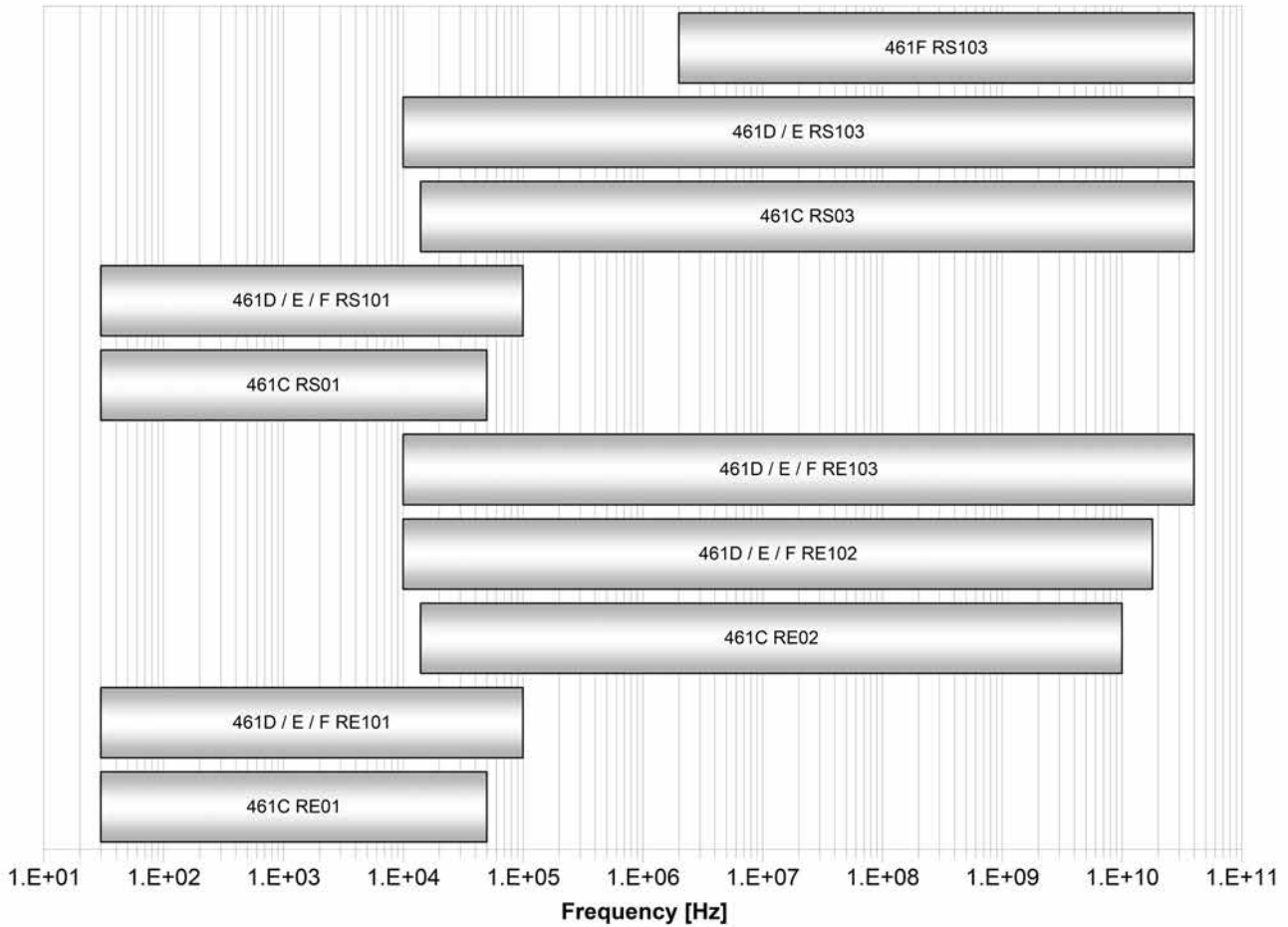

MIL-STD-461 Conducted Emission and Susceptibility Requirements

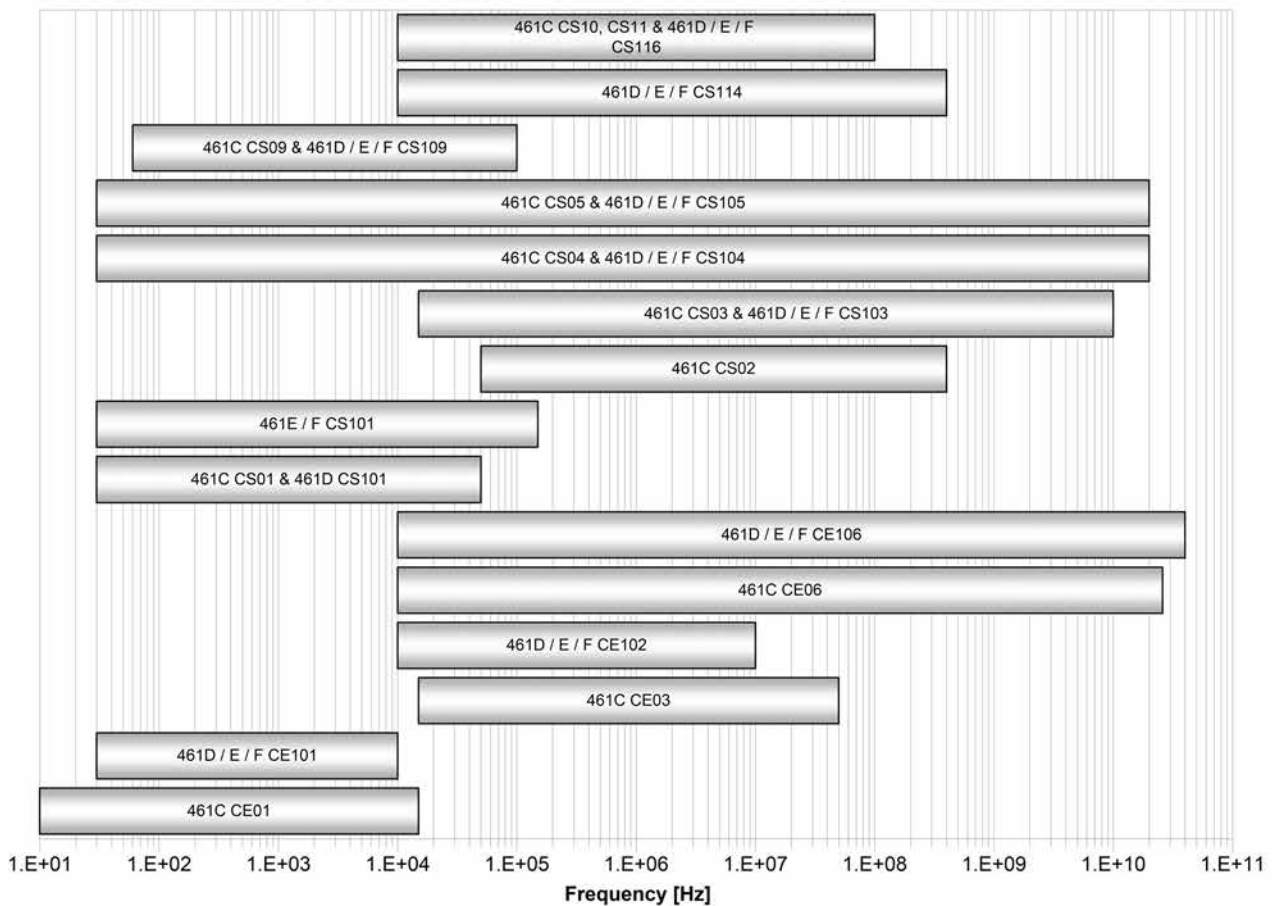

Power Leads Characteristics

While designing a Filtered and/or Transient Protected Connector, the characteristics of power leads contacts might be critical. By defining the power leads characteristics correctly, the connector and its characteristics will be designed appropriately. Therefore, in any known case of power leads characteristics, the relevant standard or test procedure must be considered, mentioned or described. Herein are parts of the most common standards that define power leads characteristics.

MIL-STD-461 - Requirements for the Control of Electromagnetic Interference Characteristics of Subsystems and Equipment

MIL-STD-461C CS06, conducted susceptibility, spikes, power leads

Applicability. This Requirement is applicable to equipment and subsystem AC and DC power leads, including grounds and neutrals which are not grounded internally to the equipment or subsystem.

Limits. The test sample shall not exhibit any malfunction, degradation of performance, or deviation from specified indications, beyond the tolerances indicated in the individual equipment or subsystem specification, when the test spikes having the waveform shown on the following figure are applied to the AC and DC power input leads for a period of not less than 1 minute at each phase position, and for a total test period not exceeding 15 minutes in duration. The values of E() and t() are given below. Each spike shall be superimposed on the powerline voltage waveform.

Part	Spike	E	t
2, 3	1: All services	200V	10µs ± 20%
	2. Air Force and Navy	200V	0.15µs ± 20%
4	1: Army	100V	10µs ± 20%
	2. Navy	400V	5µs ± 20%
5, 6, 7		400V	5µs ± 20%

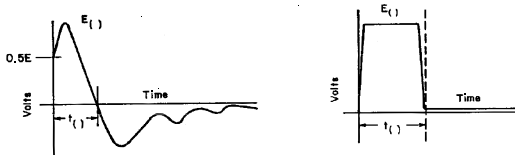

NOTE: The test sample shall be subjected to the spike(s) with the waveform shown and with the specified voltage(s) and pulsewidth(s).

MIL-STD-461F CS106, conducted susceptibility, transients, power leads

Applicability. This requirement is applicable to submarine and surface ship equipment and subsystem AC and DC input power leads, not including grounds and neutrals.

Limit. The EUT shall not exhibit any malfunction, degradation of performance, or deviation from specified indications, beyond the tolerances indicated in the individual equipment or subsystem specification, when subjected to a test signal with voltage levels as specified in the following figure.

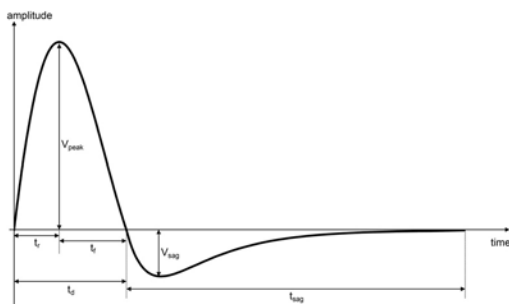

Where:

V_{peak} = 400 volt peak

t_r = 1.5µsec, ± 0.5µsec

t_f = 3.5µsec, ± 0.5µsec

t_d = 5.0µsec, ± 22%

V_{sag} ≤ 120 volt peak (maximum)

t_{sag} ≤ 20µsec

MIL-STD-461D/E/F CS116, conducted susceptibility, damped sinusoidal transients, cables and power leads, 10kHz to 100MHz.

Applicability. This Requirement is applicable to all interconnecting cables, including power cables, and individual high side power leads. Power returns and neutrals need not be tested individually.

Limits. The EUT shall not exhibit any malfunction, degradation of performance, or deviation from specified indications, beyond the tolerances indicated in the individual equipment or subsystem specification, when subjected to a signal having the waveform shown in figure CS116-1 and having a maximum current as specified in figure CS116-2. The pulses shall be applied for a period of five minutes.

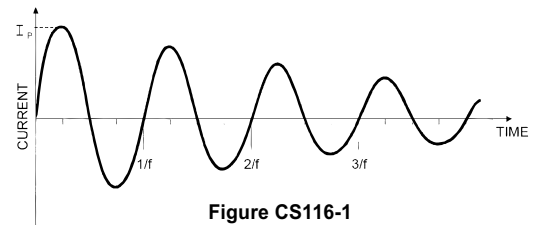

NOTES: 1. Normalized waveform: $e^{-Q\pi t} / Q \sin(2\pi f t)$

Where:

f = Frequency (Hz)

t = Time (sec)

Q = Damping factor, 15 ± 5

2. Damping factor (Q) shall be determined as follows:

$$Q = \frac{\pi(N-1)}{\ln(I_P/I_N)}$$

Where:

Q = Damping factor

N = Cycle number (i.e. N = 2, 3, 4, 5, ...)

I_P = Peak current at 1st cycle

I_N = Peak current at cycle closest to 50% decay

ln = Natural log

3. I_P as specified in figure CS116-2

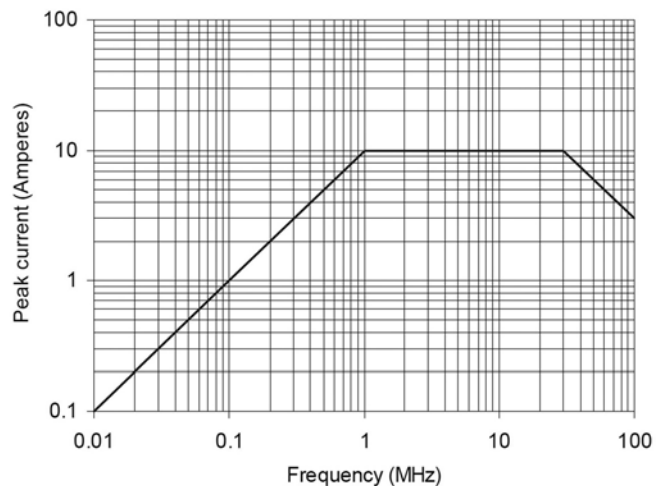
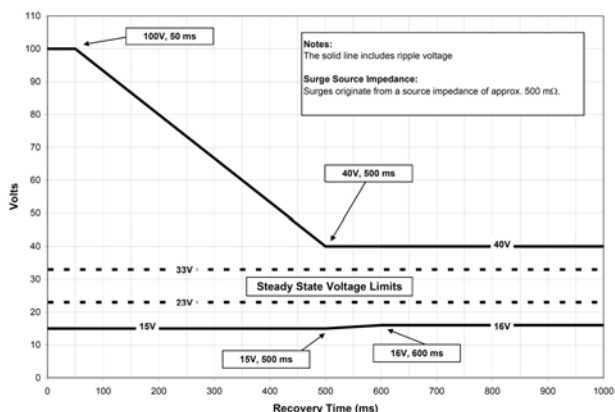

Figure CS116-2

MIL-STD-1275 - Characteristics of 28VDC Electrical Systems in Military Vehicles

This standard covers the limits of steady state and transient voltage characteristics 28VDC electrical power systems for military ground vehicles. The following figures represents MIL-STD-1275D Generator-only Mode:



Envelope of Surges

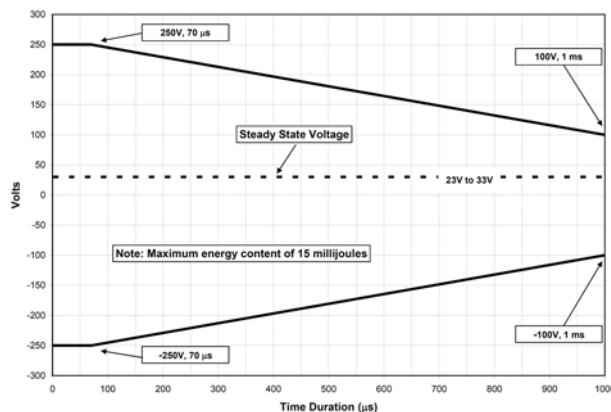

Envelope of Spikes

MIL-STD-704 - Aircraft Electric Power Characteristics

This standard establishes the requirements and characteristics of aircraft electric power provided at the input terminals of electric utilization equipment. Electromagnetic interference and voltage spikes are not covered by this standard. The following figures represents MIL-STD-704F:

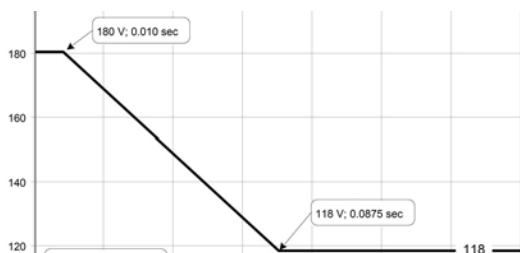

Normal 400Hz AC Voltage Transient

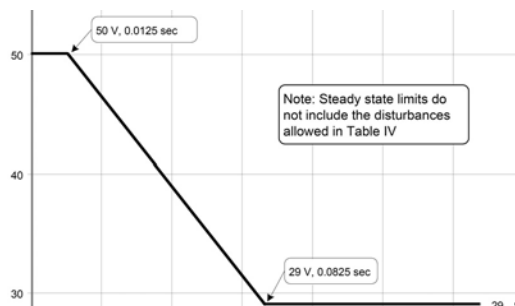

Normal Voltage Transients for 28 volts DC system

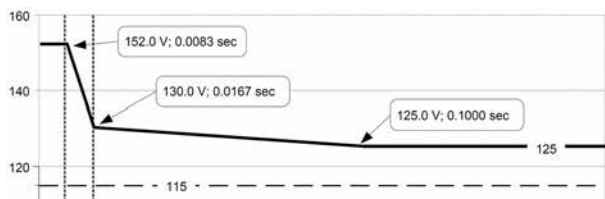

Normal 60Hz Voltage Transient

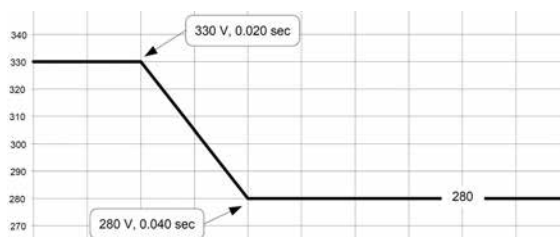

Normal Voltage Transient for 270 volts DC system

MIL-STD-1399 - Interface Standard for Shipboard Systems, Electric Power, Alternating Current

Section 300A establishes electrical interface characteristics for shipboard equipment utilizing AC electric power to ensure compatibility between user equipment and the electric power system.

Classification. Types of shipboard electric power to be supplied from the electric power system are as follows:

Power Classification		Voltage Transients (>1ms)		Voltage Spike (<1ms)					
		Tolerance	Recovery Time	Peak Value	Wave Shape				
Type I	440V or 115V 60Hz ungrounded	±16%	2s	±2,500V (440V sys) ±1,000V (115V sys)					
						440V or 115V 400Hz ungrounded	±16%	2s	±2,500V (440V sys) ±1,000V (115V sys)

The RTCA/DO-160 - Environmental Conditions and Test Procedures for Airborne Equipment

The RTCA/DO-160 defines: "a series of minimum standard environmental test conditions and applicable test procedures for airborne equipment". Over the recent years, it has become to the most common standard for defining "Lightning Induced Transient Susceptibility" tests. The following sections and figures represents RTCA/DO-160E:

Section 16 - Input Power

Section 16 defines "the test conditions and procedures for AC and DC electrical power applied to the terminals of the EUT".

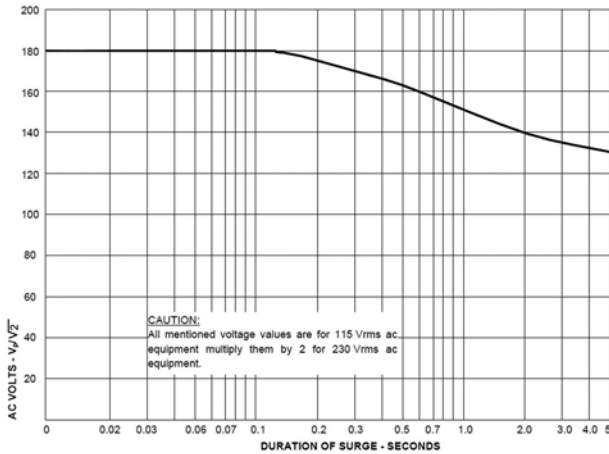

Envelope of AC Abnormal Voltage Surges

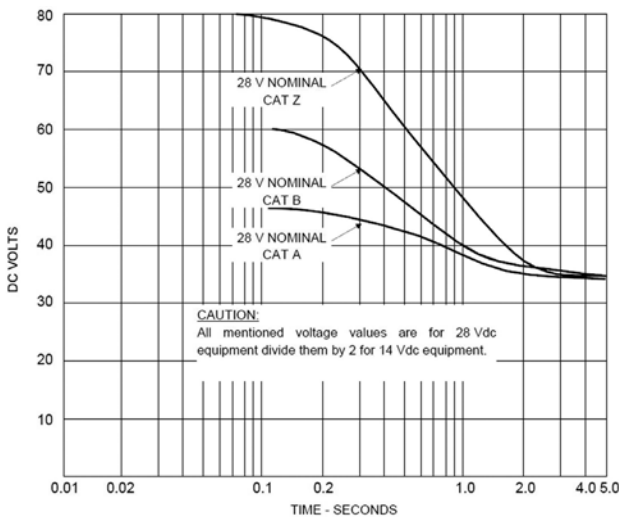

Typical Abnormal DC Surge Voltage Characteristics

Section 17 - Voltage Spike

Section 17 determines "whether the equipment can withstand the effects of voltage spikes arriving at the equipment on its power leads, either AC or DC".

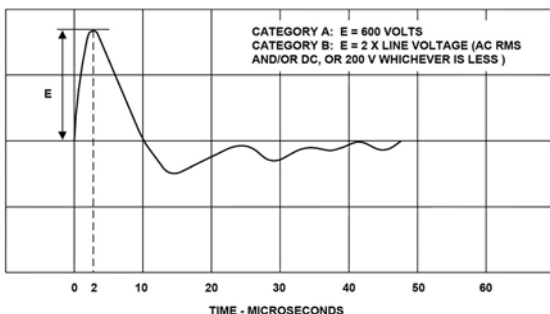

Voltage Spike Waveform

Section 22 - Lightning Induced Transient Susceptibility

Section 22 "apply idealized waveforms to verify the capability of equipment to withstand effects of lightning induced electrical transients".

Section 22 defines two groups of test, the pin injection tests and the cable bundle tests. The required tests are described by category designation which consists of five characters:

A, B or Z	1 to 5 or Z	Z or X	Z or X	Z or X
Pin Injection Test Waveform Set	Pin Injection Test Level	Cable Bundle Test Waveform Set	Cable Bundle Single and Multiple Stroke Test Level	Cable Bundle Multiple Burst Test Level

Z indicates that the waveform set, the test configuration or the levels applied are different from the designated and the tests are conducted at voltage and/or current levels other than specified in the RTCA/DO-160E. In such case, the specific test conditions and levels shall be described.

The following table shows the **Pin Injection Test Requirements** according to the RTCA/DO-160E:

Waveform Set	Test Type	Test Levels	Waveform Nos.	Notes
A	Pin Injection	1 to 5	3, 4	Waveform 3 is applied at 1.0MHz (±20%)
B	Pin Injection	1 to 5	3, 5A	Waveform 3 is applied at 1.0MHz (±20%)

The following table shows the **Test Levels for Pin Injection** according to the RTCA/DO-160E:

Level	Waveforms					
	3		4		5A	
	Voc	Isc	Voc	Isc	Voc	Isc
1	100	4	50	10	50	50
2	250	10	125	25	125	125
3	600	24	300	60	300	300
4	1500	60	750	150	750	750
5	3200	128	1600	320	1600	1600

Where V_{oc} is the Peak Open Circuit Voltage (Volts) and I_{sc} is the Peak Short Circuit Current (Amps).

Waveform 3

Waveform 3 is defined as 1MHz decaying sine or cosine/damped oscillatory wave as shown in the next figure:

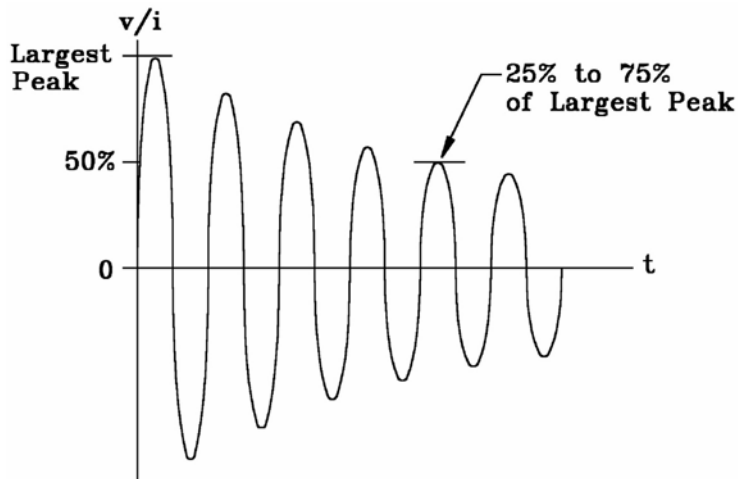

Waveform 4

Waveform 4 is defined as decaying exponential pulse as described below:

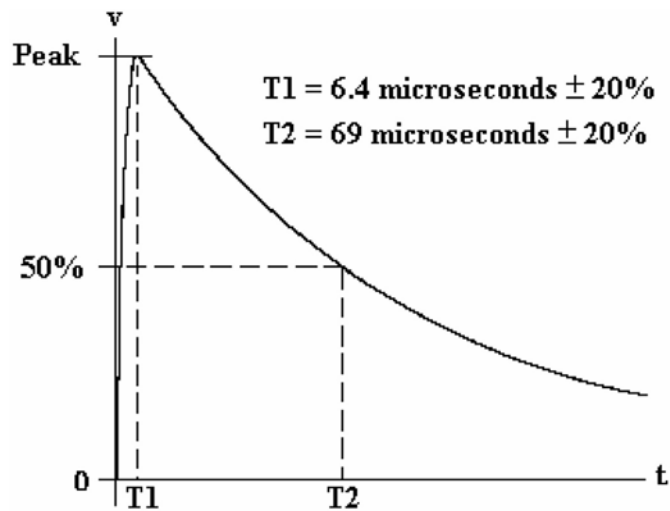

Waveform 5

Waveform 5 is defined as decaying exponential pulse as described below:

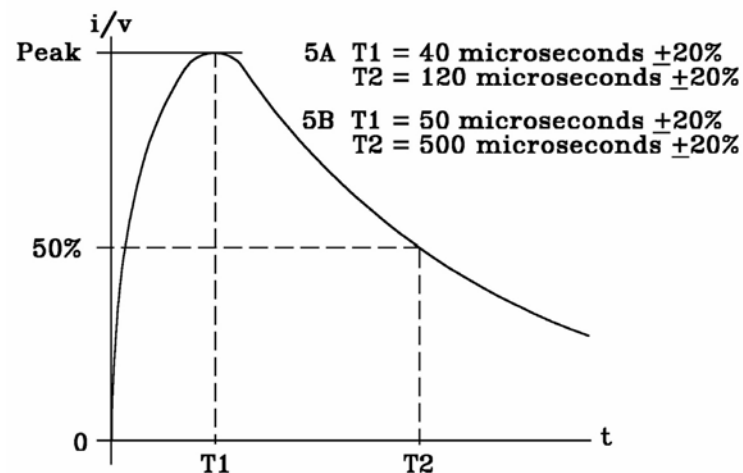

Selecting Filter Topology

Low pass passive filters are most commonly used to reduce EMI. There are several basic topologies of these filters -

C and C², L, LC, CL, π, Double π (or Hi - Filter). Selecting the wrong filter topology may result in system oscillation and malfunction. Selecting the right filter topology is critical to significant EMI reduction and best system performance. The available RF Immunity filter topologies, performances and applications are described in the following table.

Note that an "In" indicates the mating side and an "Out" indicates the rear side (termination) connector rear end.

Filter Topology Name	Filter Schema	Application	Theoretical f_{co} (Cut off Frequency)	Theoretical Insertion Loss
C And C ²		<ul style="list-style-type: none"> The best performance is achieved when used with high impedance load and source Theoretical slope: -20 db/dec 	$f_{co} = \frac{1}{\pi RC}$	
L		<ul style="list-style-type: none"> The best performance achieved when used with low impedance load and source Theoretical slope: -20 db/dec 	$f_{co} = \frac{R}{\pi L}$	
LC		<ul style="list-style-type: none"> The best performance is achieved when used with high impedance load and low impedance source Theoretical slope: -40 db/dec 	$f_{co} = \frac{1}{\pi\sqrt{LC}}$	
CL		<ul style="list-style-type: none"> The best performance is achieved when used with low impedance load and high impedance source Theoretical slope: -40 db/dec 	$f_{co} = \frac{1}{\pi\sqrt{LC}}$	
Pi		<ul style="list-style-type: none"> The best performance is achieved when used with high impedance load and source Theoretical slope: -60 db/dec 	$f_{co} = \frac{1}{\pi\sqrt{2LC}}$	
Hi		<ul style="list-style-type: none"> The best performance is achieved when used with high impedance load and source Theoretical slope: -120 db/dec 	$f_{co} = \frac{1}{\pi\sqrt{2LC}}$	

Estimation of filter cut off frequency

Once the filter topology is selected, the filter Cut Off Frequency can be determined.

The filter cut off frequency is defined as the -3 db attenuation frequency. Attenuation -3 db means that half of the transmitted power is dissipated across the filter. The -3 db cut off frequency is considered to be the highest operation limit of the low pass filter range. The filter will attenuate dramatically all signals with frequency above the cut off frequency.

If the selected cut off frequency will be too low in comparison to the signal frequency and rise time, the filter will distort the signal shape.

If it will be too high, undesired high frequency noise will be a part of the signal shape. Therefore the selection of the proper cut off frequency is crucial to the signal integrity.

To make the proper selection of the filter cut off frequency, the designer must estimate the spectrum of the signal.

The data pulse usually used in electronic systems is trapezoid in shape, with finite rise and fall times.

Single trapezoid

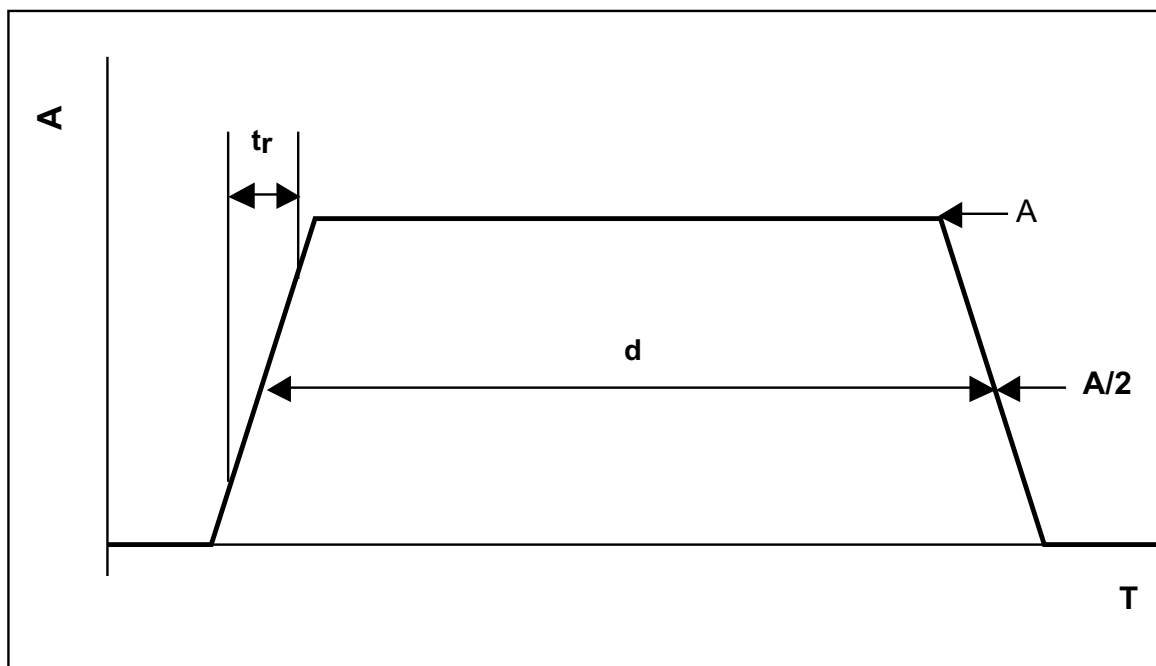

- **A** - the pulse amplitude
- **d** - the pulse duration; is the time interval in which the pulse value is higher than 50% of the amplitude
- **t_r** - the pulse rise time; is the required time for the signal to go from 10% to 90% of its amplitude.

Analyzing the pulse using the Fourier method, the following frequency domain graph is obtained.

The graph can help designers in estimating the spectrum of trapezoidal pulses.

Spectrum of trapezoidal data pulse

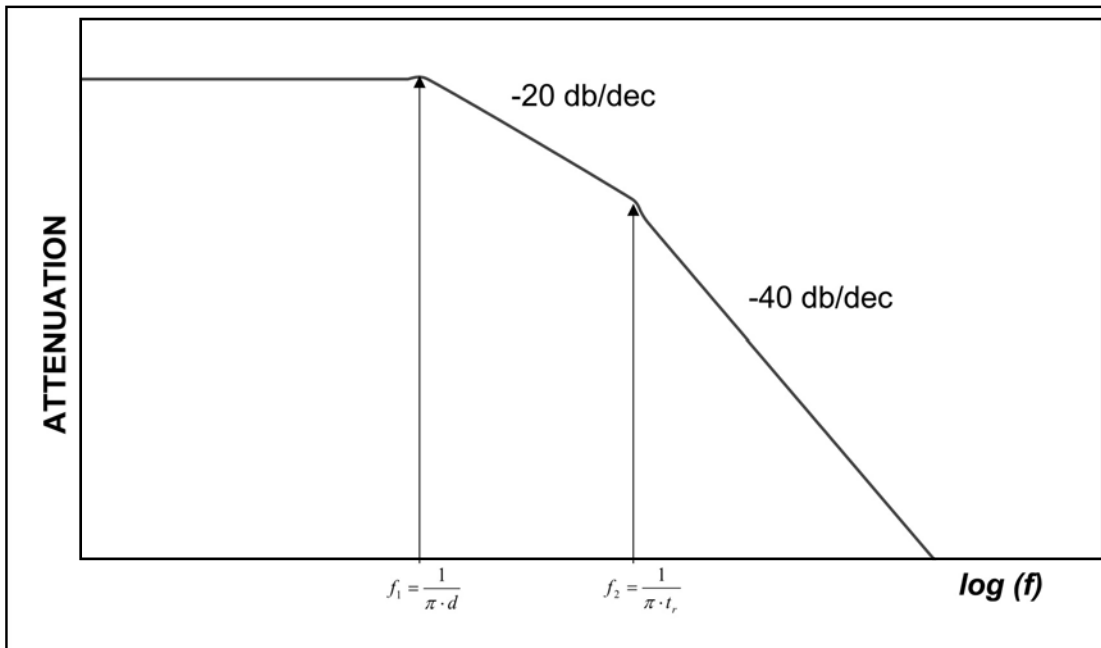

f_1 - the first corner frequency ; f_2 - the second corner frequency

Please note, that the amplitude (dB) of the spectrum is different for a single data pulse and for a data pulse train, but the corner frequencies remain the same:

$$f_1 = \frac{1}{\pi \cdot d} \quad ; \quad f_2 = \frac{1}{\pi \cdot t_r}$$

The proper filter cut off frequency can be estimated by the following rule of thumb:

$$f_{co} = 10 \cdot f_2$$

where f_{co} is filter cut off frequency.

If an estimation of the cut off frequency is based on f_1 instead of f_2 , and/or the coefficient is selected smaller than 10; the resulting filtered signal could be distorted.

However in many cases the designer uses devices with very fast rise and fall times (t_r & t_f) while the signal duration (d) is very long compared to the transition times. The t_r is not a critical factor in these cases. Slowing down the transition times (t_r & t_f) at those designs is possible and actually can be a very good idea. So the estimated cut off frequency of the filter can be determined as follows:

$$f_{co} = (2 \div 3) \cdot f_2$$

When using both the filter and the transient protection on the similar signal line, the approximation of the common cut off frequency can be calculated using the equation of the C Filter presented on page 75 and assigning the total capacitance of the filter and the transient protection to that equation.

$$f_{co} = \frac{1}{\pi R C_T} \quad ; \quad C_T = C_F + C_{TP}$$

C_T - Total Capacitance

C_F - Typical Capacitance of the Filter

C_{TP} - The Capacitance of Transient Protection

About Filter Performance Measuring Methods

S-parameters measurements are commonly in use to express the insertion loss of single-ended contacts in filtered connector. While measuring insertion loss of balanced filter, Mixed-mode S-parameter should be the method in use.

Since differential signals are becoming more common in military and avionic applications, RF immunity constantly develops and manufactures solutions for these types of signals. By using differential filtering topologies and balanced components, the EMI couple in the common-mode and cancel in differential mode. RF immunity has the abilities to measure the insertion loss of single-ended and balanced filters, according to signals descriptions and customer requirements, by these two following methods:

1. Single-ended lines - S-parameters (Scattering parameters) per MIL-STD-220 under 50Ω source and load impedance, no-load. This method is in use for two-port network models. The measuring range starts at 100kHz and ends at 1.8GHz.
2. Balanced lines (differential pairs) - Mixed-mode S-parameter. By using Mixed-mode S-parameter, both common mode insertion loss and differential mode insertion loss can be measured correctly. This method ensures that no differential degradation is occurring.

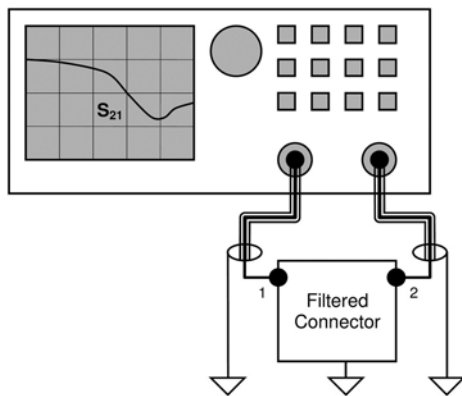

1. S-parameters
S₂₁ - common mode insertion loss

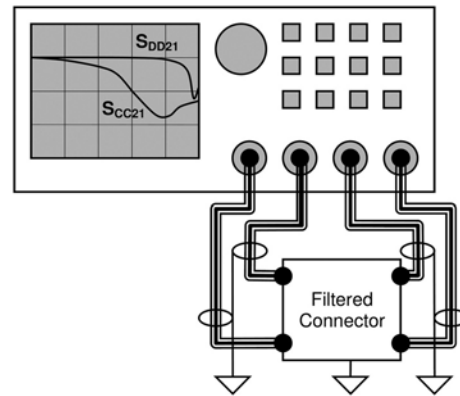

2. Mixed-mode S-parameter
S_{CC21} - common mode insertion loss
S_{DD21} - differential mode insertion loss

Filter performance in non-50Ω system

If your system is not 50Ω matched, you can use the following formula for predicting the filter performance when used with other sources and/or load impedances.

$$\text{Attenuation [db]} = 20 \log \left[1 + \frac{Z_s Z_L}{Z_{12}(Z_s + Z_L)} \right]$$

Z_S - Source Impedance

Z_L - Load Impedance

Z₁₂ - Transfer Impedance

The transfer impedance Z₁₂ can be calculated using the following graph:

Attenuation VS. Transfer Impedance in 50Ω System

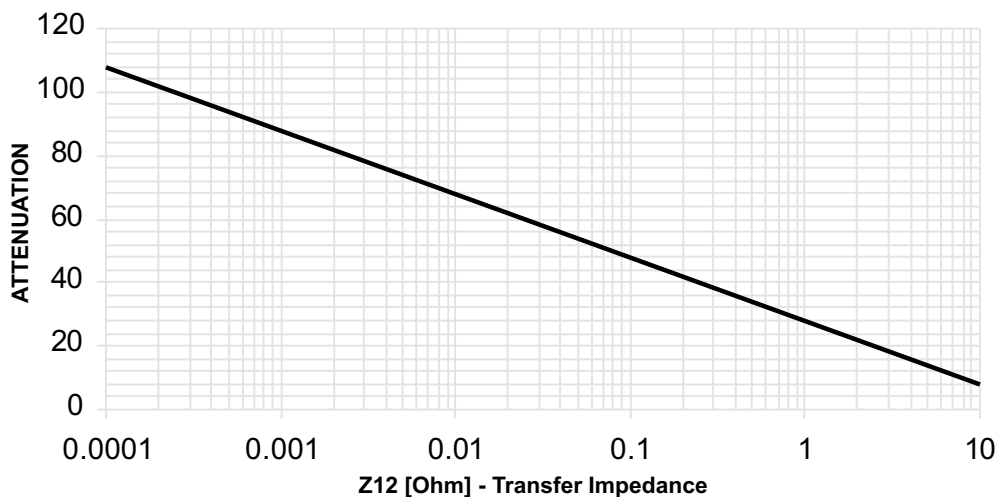

* Filter Performance at non-50Ω System.

Circular Filter Connectors Check List

Basically, the easiest way to define Filter Connector is to follow the HTO (How To Order) pages. However, additional information of the specific connector/system application could be helpful for our engineers to either support your request or recommend for "of the shelf" product and/or customized solution.

The next form will help you to describe properly your needs; mechanically, environmentally, electrically, the predicted or already measured interferences and, thus, will give us the tools to learn, check and response to your request correctly. In case that additional information is available, please feel free to share it with us.

This form is also available on our website: <http://www.rfimmunity.com>

1. General Description

R.F. Immunity P/N (based on HTO): _____

Cross Reference Connector P/N

or Filter Connector P/N (if exists): _____

2. Connector Description

Family:	<input type="checkbox"/> MIL-DTL-38999 <input type="checkbox"/> MIL-DTL-26482 <input type="checkbox"/> MIL-DTL-83723 <input type="checkbox"/> Other:
Series:	<input type="checkbox"/> Series I <input type="checkbox"/> Series II <input type="checkbox"/> Series III <input type="checkbox"/> Other:
Shell Style:	<input type="checkbox"/> Jam Nut Receptacle <input type="checkbox"/> Plug <input type="checkbox"/> Wall Mount Receptacle <input type="checkbox"/> Rear Wall Mount Receptacle <input type="checkbox"/> Box Mount Receptacle <input type="checkbox"/> Rear Box Mount Receptacle <input type="checkbox"/> Other:
Material & Finish	<input type="checkbox"/> Aluminum Alloy, Electroless Nickel Plating <input type="checkbox"/> Aluminum Alloy, Olive Drab Cadmium Plating <input type="checkbox"/> Aluminum Alloy, Zinc Cobalt Plating <input type="checkbox"/> Stainless steel, Passivated, Corrosion Resistant, Without Firewall Capability <input type="checkbox"/> Other:
Shell Size:	<input type="checkbox"/> 08/09 <input type="checkbox"/> 10/11 <input type="checkbox"/> 12/13 <input type="checkbox"/> 14/15 <input type="checkbox"/> 16/17 <input type="checkbox"/> 18/19 <input type="checkbox"/> 20/21 <input type="checkbox"/> 22/23 <input type="checkbox"/> 24/25 <input type="checkbox"/> Other:
Insert Arrangement: (Two Digits)	(Please use our lists for each family or consult us for other arrangements)
Contact Type: (Gender)	<input type="checkbox"/> Pin <input type="checkbox"/> Socket <input type="checkbox"/> Other (Please mention wherever Coaxial, Twinax or Optical contact are in use)
Termination:	<input type="checkbox"/> Solder Cup <input type="checkbox"/> Crimp (requires extended shell) <input type="checkbox"/> PCB Tail (Tin Plated) <input type="checkbox"/> PCB Tail (Gold Plated) <input type="checkbox"/> Long PCB Tail (Tin Plated) <input type="checkbox"/> Long PCB Tail (Gold Plated) <input type="checkbox"/> Other:
Polarization:	<input type="checkbox"/> N <input type="checkbox"/> A <input type="checkbox"/> B <input type="checkbox"/> C <input type="checkbox"/> D
Sealing:	<input type="checkbox"/> Standard (Up to 10 ⁻³ cc/s @ Δ P = 1atm) <input type="checkbox"/> Hermetic (Up to 10 ⁻⁵ cc/s @ Δ P = 1atm)
Potting:	<input type="checkbox"/> Covered Teeth by Epoxy Cast (default) <input type="checkbox"/> Exposed Teeth (only if required) <input type="checkbox"/> Other:

Circular Filter Connectors Check List

3. Electrical Characteristics for Homogeneous Filtered and/or Protected Connector

Working Voltage [V _{DC}]:	<input type="checkbox"/> 50	<input type="checkbox"/> 100	<input type="checkbox"/> 200	<input type="checkbox"/> 250	<input type="checkbox"/> 500	<input type="checkbox"/> 1000	<input type="checkbox"/> Other:	
Filter Type:	<input type="checkbox"/> C	<input type="checkbox"/> C ²	<input type="checkbox"/> L	<input type="checkbox"/> LC	<input type="checkbox"/> CL	<input type="checkbox"/> Pi (π)	<input type="checkbox"/> Hi (2π)	<input type="checkbox"/> Other:
Capacitance:								
Energy [Joule]:	<input type="checkbox"/> 0.1	<input type="checkbox"/> 0.2	<input type="checkbox"/> 0.3	<input type="checkbox"/> 0.6	<input type="checkbox"/> Other:			

4. Electrical Characteristics for Special Filter (Please write contacts numbers separated by commas, for example: 1-4, 7-10)

Contacts Number:								1-4, 7-10
Signal Description:								RS-422
Operation Frequency [Hz]:								200kHz
Current Rating [A]:								2A
Working Voltage [V _{DC} / V _{AC}]:								±15V _{DC}
Filter Type:								C
Capacitance:								470pF
Energy [Joule]:								0.1J

5. Predicted or Measured Interference Level

Interference Level [dB] per Frequency [Hz]:	[dB] @	[kHz]	[dB] @	[kHz]
	[dB] @	[MHz]	[dB] @	[MHz]

6. EMC Standards & Requirements

(Please specify in particular Conducted Susceptibility and Transients Requirements)

7. Additional Information

Check List

Terms and Conditions

RF Immunity

RF Immunity Ltd. ("Seller")'s Standard Terms and Conditions of Sale are an integral part of Seller's Quotation and/or final Order Confirmation and/or Acknowledgment of Purchaser's Order. Purchaser shall note these Standard Terms and Conditions on receipt of the Quotation and/or Order Acknowledgment and expressly accepts them by placing the order with Seller.

1. DEFINITIONS

"Seller" shall refer to RF Immunity Ltd. or any entity that owns or is owned or controlled directly or indirectly by RF Immunity Ltd. "Purchaser" shall refer to the entity that receives and accepts Seller's Quotation, and/or Order Acknowledgment. "Product" and "products" include goods/services sold to Purchaser by Seller.

2. OFFER TO SELL

Seller's Quotation is an offer to sell its product on the terms and conditions stated herein, and is not an acceptance of any offer or the confirmation of an existing agreement. The quoted prices in the Quotation are fixed and valid for the time period shown on the front of the Quotation and/or as specifically identified herein. All prices quoted are exclusive of taxes, insurance, freight charges or other incidental expenses, which are the responsibility of Purchaser. No reference herein to Purchaser's purchase order or any other document prepared by, or communication with Purchaser shall constitute Seller's acceptance of any term or condition therein which varies from these Terms and Conditions.

3. ACCEPTANCE AND CONFLICTING TERMS

Seller's Standard Terms and Conditions of Sale may not be contradicted by evidence of any prior agreement or of a contemporaneous oral agreement and may only be explained, supplemented, modified, altered, waived or superseded by a writing signed by both parties. These Standard Terms and Conditions, together with those of Purchaser's terms that are not inconsistent with them and do not: (i) require Seller to take any action beside the supply of its product and finished product test data; (ii) impose restrictions on Seller's activities in addition to those imposed directly by government statutes, or (iii) add to Seller's obligations, shall constitute the agreement between Purchaser and Seller (the "Additional Purchase Terms"). Terms imposing any different or additional obligations are expressly rejected. Seller may send written confirmation of the purchase order (the "Order Acknowledgment") but Seller hereby objects to and rejects any additional terms (other than additional terms that meet the requirements of Additional Purchase Terms) or different terms, including those contained in Purchaser's purchase order, unless Seller expressly identifies and agrees to such terms in writing in the Order Acknowledgment. These Standard Terms and Conditions together with the Additional Purchase Terms constitute the parties' agreement ("Agreement"). These Standard Terms and Conditions shall govern any changes made to the requirements of the Agreement. It is Seller's intent that its Quotation be treated as an offer. However, if Purchaser's purchase order or any other correspondence from Purchaser is deemed to be an offer, Seller's acceptance of Purchaser's offer is expressly conditioned on assent to these Standard Terms and Conditions.

4. PAYMENTS

Payment is due as stated on Seller's Invoice or, if not stated thereon, net 30 days from the date that Products were delivered. Purchaser agrees to pay interest at 18% per annum (1.5% per delayed month) on all invoices not paid in full by the due date. Seller reserves the right to alter Purchaser's credit limit, if any, at any time, or to require payment for any order prior to delivery. Purchaser's failure to make any payments requested by Seller shall give Seller the option to cancel this Agreement or to delay delivery without otherwise affecting Seller's rights hereunder. Payment shall be made in the currency specified by Seller. As partial payment of sums due Seller may accept any check or tender of payment without entering into an accord and satisfaction, without waiver, and without prejudice to Seller's right to full payment of the remainder due or to become due hereunder notwithstanding any terms or conditions endorsed on or stated in any communication related to such check or tender. Seller may apply any payment tendered by Purchaser to any amount owed to Seller by Purchaser whether under this Agreement or otherwise.

All orders under 1000\$, excluding blanket order arrangement spreads, will be surcharged with Money Transfer Commission of 25\$.

5. INSPECTION AND ACCEPTANCE OF GOODS

Purchaser must check any Order Acknowledgment and immediately inform Seller in writing of any error or anomaly within three 3 days of receipt of Order Confirmation.

6. DELIVERIES

Seller's obligation with respect to each item and delivery date shall be separate and distinct. Delivery dates are to be treated as estimates only. Seller reserves the right to adjust shipment schedules from time to time with notice to Purchaser. Seller's failure to make delivery of any item or to meet any delivery date shall not affect either party's obligation with respect to any remaining items or deliveries specified in this Agreement. Purchaser should confirm the suitability of Seller's standard manufacturing lead times when placing orders. With respect to each delivery obligation contained in this Agreement: (i) Tender of a shipment to any licensed carrier shall constitute delivery to Purchaser; (ii) Seller shall use its commercially reasonable efforts to deliver in accord with the schedule specified

in this Agreement. Any delivery not in dispute shall be paid for in accordance with that order's terms to Purchaser, regardless of any dispute as to the other delivered or undelivered goods. Seller is not obligated to package goods for outside storage. Deliveries of up to ten percent (10%) above or below quantities specified in the order shall be accepted by Purchaser and the invoice price will be adjusted accordingly. Unless otherwise specified by Seller, delivery is made at Purchaser's risk and expense, Ex-works at RF Immunity's site, Prat 2 St. Yavne, Israel (Shipping point). The delivery is regarded as complete once the Product leaves Seller's facility. At the written request of the Purchaser, Seller will insure the delivery at Purchaser's expense. Unless specifically instructed by Purchaser, Seller will select an appropriate method of forwarding and routing the Product.

7. INSPECTION OF PRODUCTS, CLAIMS FOR DEFECTS

Purchaser shall inspect the Product it receives within thirty (30) days after delivery or within the period required by applicable law, whichever is shorter. Seller must be notified promptly in writing of any non-conformance. With respect to defects discoverable upon reasonable inspection, all claims are waived if not made within thirty (30) days from date delivered. In the event of any claim by Purchaser regarding the quality of the Product delivered, such Product must be promptly offered to Seller for examination. Seller shall have no obligation to replace or provide credit for Product claimed to be defective unless Seller receives representative samples of the Product and is provided an opportunity to examine the Product at a place convenient to the Seller. Purchaser's right to reject Product shall at all times be limited to that portion of the Product actually defective. No Product may be returned without Seller's prior written authorization and return material authorization number. All Products for return must be freight prepaid by Purchaser. In the event the returned products were examined and determined by the seller as defective, the seller will bear the freight expenses back to purchaser after replacing the defect ones.

8. TITLE RISK OF LOSS

Unless otherwise agreed by the parties in writing, risk of loss or damage to the Product shall pass to Purchaser upon delivery to a common carrier. After Seller's delivery of the Products to the common carrier, all charges of freight, handling and insurance are the responsibility of the Purchaser. Purchaser assumes all risk of loss or damage after delivery of the Products to the carrier; any claims for loss or damage shall be made by Purchaser directly with the carrier. Purchaser shall take title to the Product upon Seller's receipt of payment for the Product delivered.

9. LIMITED WARRANTY

Seller warrants that at the time of delivery the Products sold hereunder shall be free from defects in materials and workmanship and shall conform to Seller's specifications, and, if applicable, acceptance criteria to which Seller has agreed in writing. Purchaser retains sole responsibility for determining whether the Products are fit for the intended use, and for suitability of qualification and acceptance criteria. Seller's Limited Warranty does not cover damage due to natural wear and tear, insufficient maintenance, chemical or electrolytic influences, defective wiring work or installation. Seller's Limited Warranty is void if Purchaser or third parties carry out modifications or repairs on the Product without the prior written agreement of Seller. Claims for defects must be received by Seller in writing within one (1) year from Seller's delivery of Product on which the claim is based or such longer period as required by applicable law. Purchaser's exclusive remedy will be limited to repair, replacement at Seller's facilities, or refund for Products which Seller verifies as defective. Seller shall determine which remedy shall apply in its sole discretion. Seller will retain all replaced parts. Except for the warranty set forth in this Section 9, unless otherwise required by applicable law, SELLER MAKES NO WARRANTY, EXPRESS OR IMPLIED, AND EXPRESSLY DISCLAIMS ANY WARRANTY OF MERCHANTABILITY OR FITNESS FOR PARTICULAR PURPOSE.

10. LIMITATION OF LIABILITY AND INSURANCE

NO CLAIM BY PURCHASER OF ANY KIND FOR DAMAGES SHALL BE GREATER IN AMOUNT THAN THE PURCHASE PRICE OF THE PRODUCT IN RESPECT OF WHICH SUCH DAMAGES ARE CLAIMED. SELLER SHALL, TO THE MAXIMUM EXTENT PERMITTED BY APPLICABLE LAW, NOT BE LIABLE FOR ANY INCIDENTAL, CONSEQUENTIAL, OR OTHER DAMAGES, INCLUDING, BUT NOT LIMITED TO, LOSS OF BUSINESS OR PROFIT, BASED ON ANY ALLEGED DESIGN OR MANUFACTURING DEFECT, NEGLIGENCE, BREACH OF WARRANTY, STRICT LIABILITY, INDEMNITY, OR ANY OTHER REASON OR LEGAL THEORY ARISING OUT OF THE USE OR HANDLING OF THE PRODUCT OR ITS PERFORMANCE HEREUNDER, TO THE EXTENT THAT SUCH LIABILITY EXTENDS SELLER'S OBLIGATIONS BEYOND THE PRICE PAID TO SELLER FOR THE PRODUCT ON WHICH SUCH CLAIM IS BASED. SELLER SHALL NOT BE LIABLE FOR ANY DIRECT OR CONSEQUENTIAL DAMAGES ARISING FROM DELIVERY DELAY, WHETHER OR NOT ARISING FROM SELLER'S NEGLIGENCE, OR FROM TRANSIT LOSS OR DAMAGE. SELLER IS NOT OBLIGED TO OBTAIN OR MAINTAIN ANY INSURANCE NOT REQUIRED BY APPLICABLE LAW. FOR PURPOSES OF THIS SECTION, SELLER SHALL INCLUDE SELLER'S AFFILIATES INCLUDING ITS PARENT COMPANY TEDER ELECTROMECHANICAL ENGINEERING, A LIMITED LIABILITY COMPANY UNDER THE ISRAELI LAW.