

PCB TERMINAL BLOCKS GENERAL CATALOGUE

Edition 1

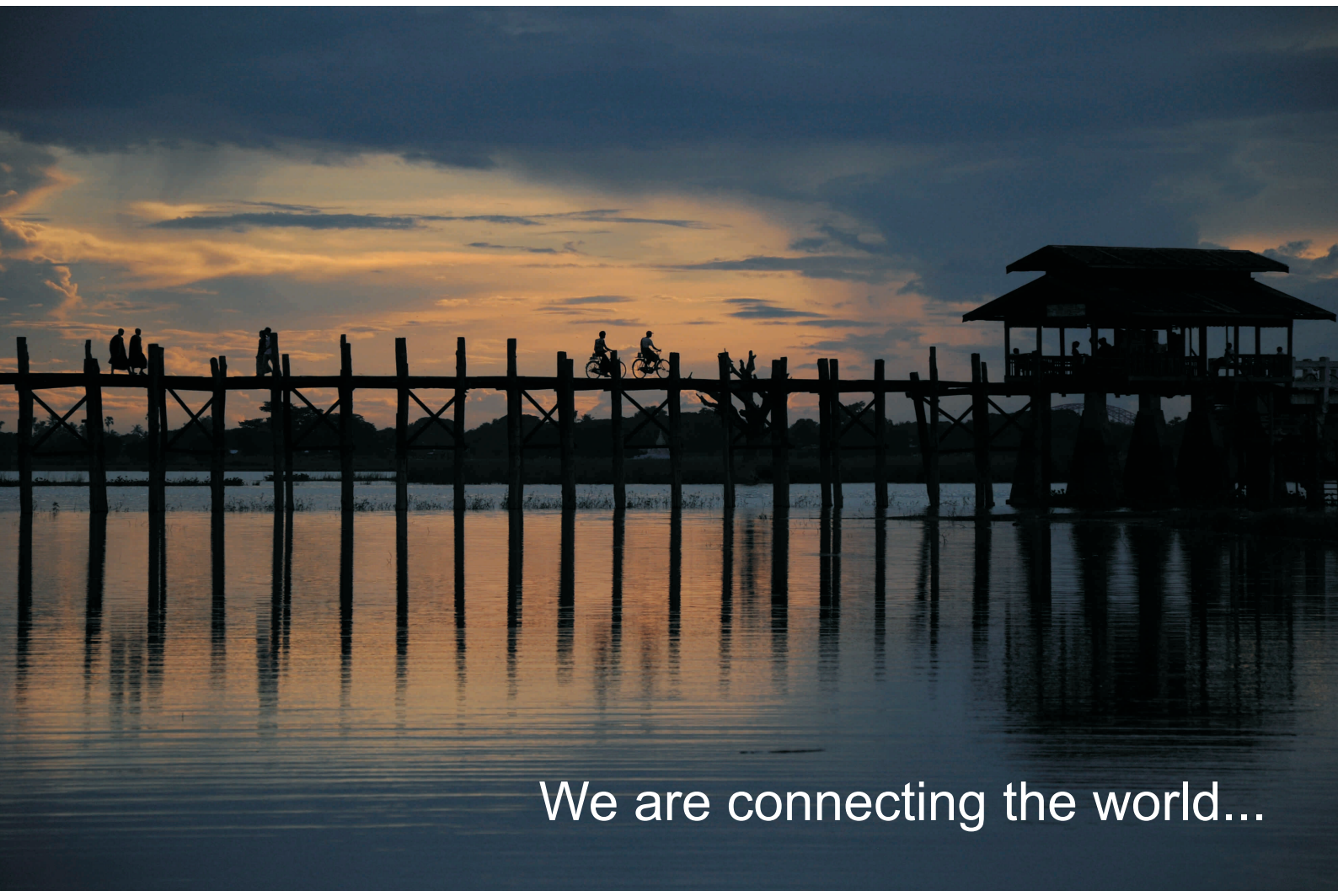

We are connecting the world...

Screw Clamp Terminal Block

3-10

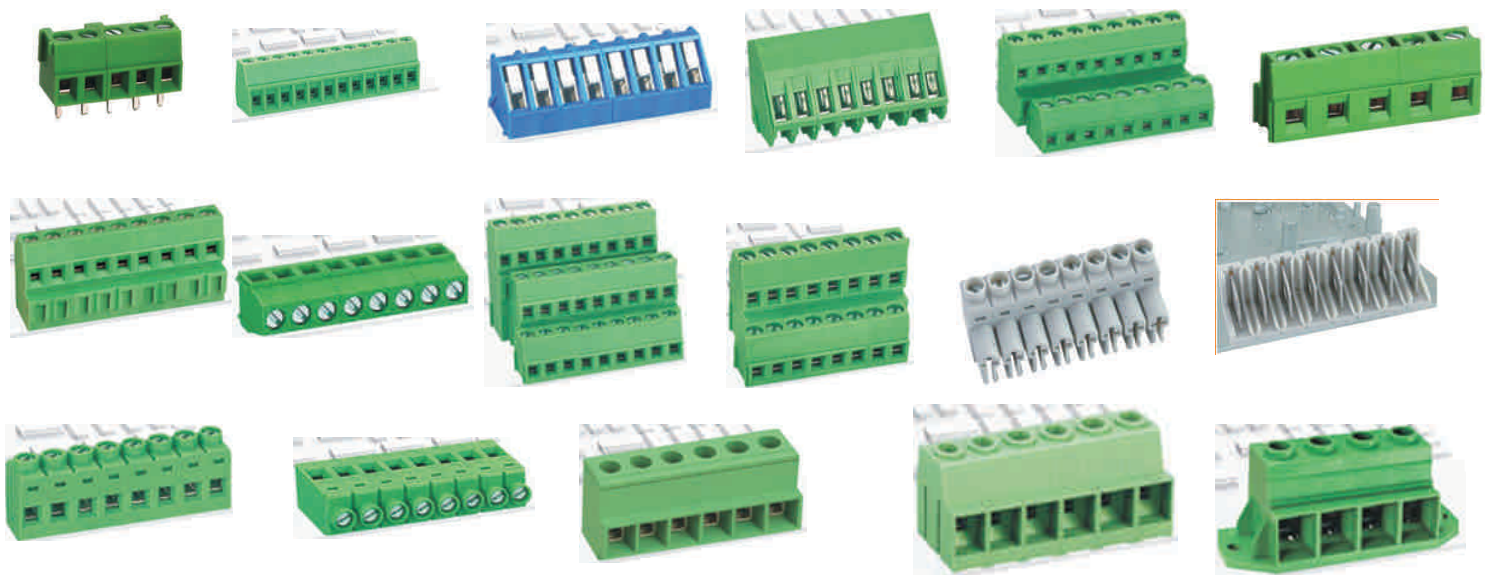

Wire Protector Terminal Block

11-14



Spring Terminal Block

15-21

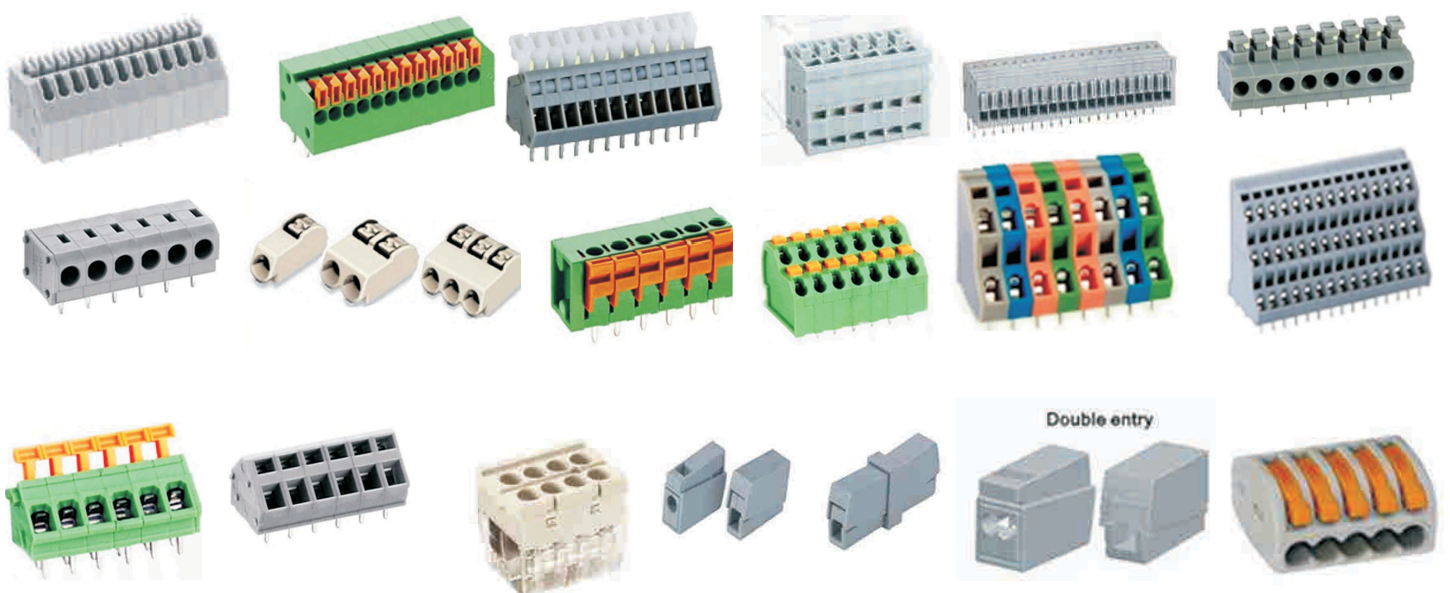

Double entry

Transformer Terminal Block

21-22



Fuse Terminal Block

23



Ceramic Terminal Block

24



DIN Rail Terminal Block Screw

25

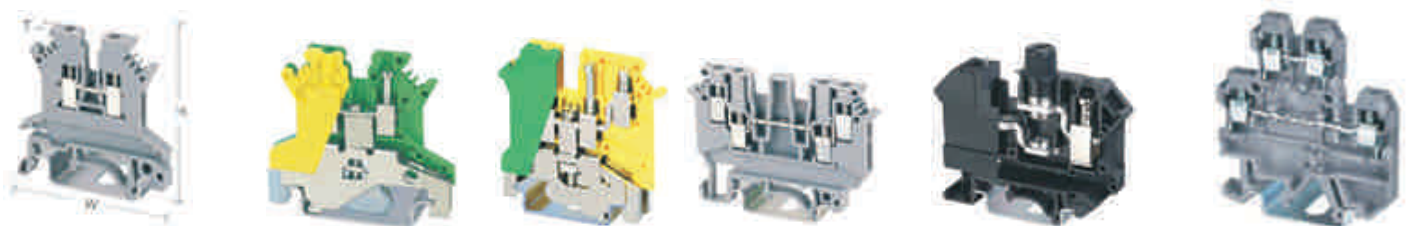

DIN Rail Ter. Block Spring and Interface Mould Housing

26



Series C09 12419 - 2,54mm Screw Clamp Terminal Block, Hor. Conductor

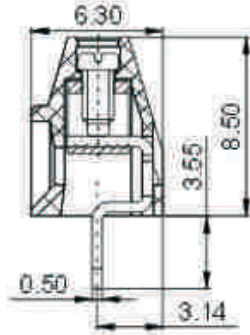

SM C09 12419 XX SS4

XX - CONTACT NO: 2-24

Contact: Brass+Tin, Green, PCB Straight
Rated Current: 8A (VDE), Rated Voltage: 130V (VDE)
Ambient Temperature: -40°C~+105°C

Series C09 13514 - 3,50mm Screw Clamp Terminal Block, Hor. Conductor
Series C09 13814 - 3,80mm Screw Clamp Terminal Block, Hor. Conductor

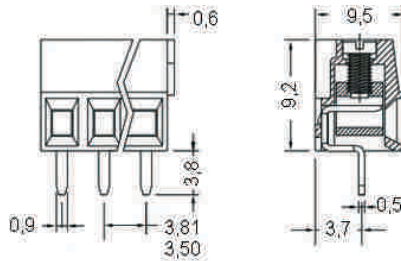

SM C09 13514 XX SS4
SM C09 13814 XX SS4

XX - CONTACT NO: 2-24

Contact: Brass+Tin, Green, PCB Straight
Rated Current: 20A (VDE), Rated Voltage: 300V (VDE)
Ambient Temperature: -40°C~+105°C

Series C09 13514 - 3,50mm Screw Clamp Terminal Block, Ver. Conductor
Series C09 13814 - 3,81mm Screw Clamp Terminal Block, Ver. Conductor

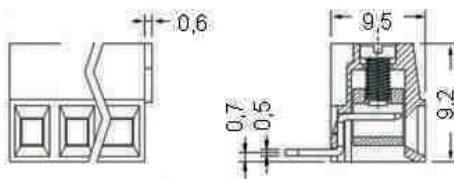

SM C09 13514 XX RS4
SM C09 13814 XX RS4

XX - CONTACT NO: 2-24

Contact: Brass+Tin, Green, PCB Right
Rated Current: 20A (VDE), Rated Voltage: 300V (VDE)
Ambient Temperature: -40°C~+105°C

Series C09 135381 - 3,50mm Screw Clamp Terminal Block, Hor. Conductor
Series C09 138381 - 3,81mm Screw Clamp Terminal Block, Hor. Conductor

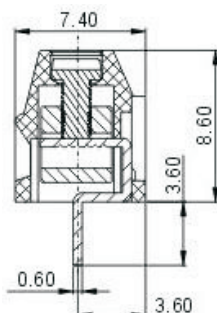

SM C09 135381 XX SS4
SM C09 138381 XX SS4

XX - CONTACT NO: 2-24

Contact: Brass+Tin, Green, PCB Straight
Rated Current: 20A (VDE), Rated Voltage: 300V (VDE)
Ambient Temperature: -40°C~+105°C

Series C09 135381 - 3,50mm Screw Clamp Terminal Block, Hor. Conductor
Series C09 138381 - 3,81mm Screw Clamp Terminal Block, Hor. Conductor

SM C09 135381 XX SS4-H
SM C09 138381 XX SS4-H

XX - CONTACT NO: 2-24

Contact: Brass+Tin, Green, PCB Straight
Rated Current: 20A (VDE), Rated Voltage: 300V (VDE)
Ambient Temperature: -40°C~+105°C

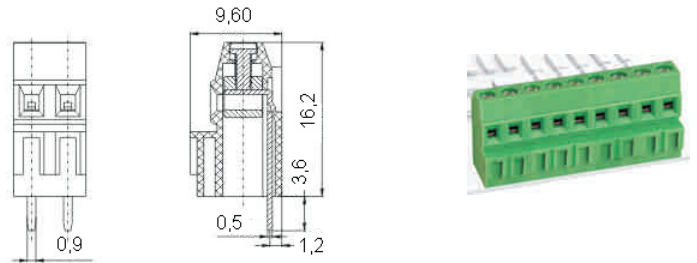

Series C09 135381 - 3,50mm Screw Clamp Terminal Block, Hor. Conductor
Series C09 138381 - 3,81mm Screw Clamp Terminal Block, Hor. Conductor

SM C09 135381 XX SS4-A
SM C09 138381 XX SS4-A

XX - CONTACT NO: 2-24

Contact: Brass+Tin, Green, PCB Straight
Rated Current: 20A (VDE), Rated Voltage: 300V (VDE)
Ambient Temperature: -40°C~+105°C

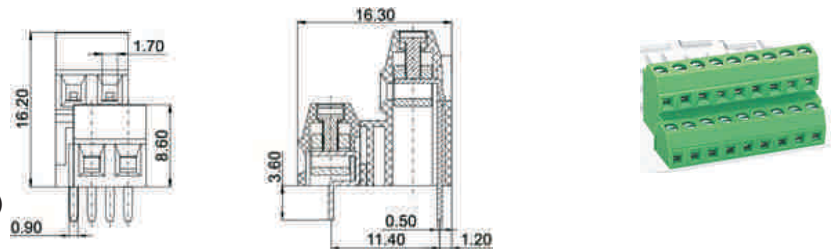

Series C09 135381 - 3,50mm Screw Clamp Terminal Block, Hor. Conductor
Series C09 138381 - 3,81mm Screw Clamp Terminal Block, Hor. Conductor

SM C09 135381 XX SS4-B
SM C09 138381 XX SS4-B

XX - CONTACT NO: 2-24

Contact: Brass+Tin, Green, PCB Straight
Rated Current: 20A (VDE), Rated Voltage: 300V (VDE)
Ambient Temperature: -40°C~+105°C

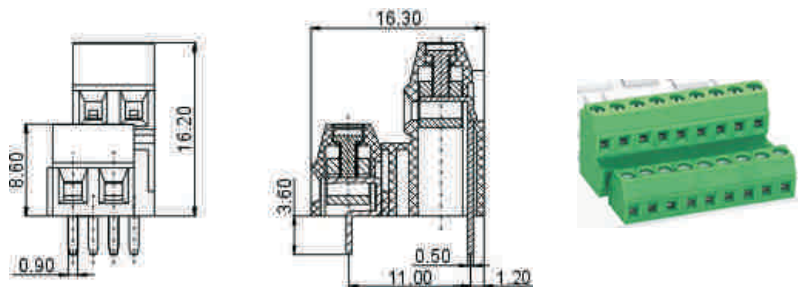

Series C09 1507 - 5,00mm Screw Clamp Terminal Block, Hor. Conductor
Series C09 1587 - 5,08mm Screw Clamp Terminal Block, Hor. Conductor
Series C09 1757 - 7,50mm Screw Clamp Terminal Block, Hor. Conductor
Series C09 1107 - 10,00mm Screw Clamp Terminal Block, Hor. Conductor

SM C09 1507 XX SS4
SM C09 1587 XX SS4
SM C09 1757 XX SS4
SM C09 1107 XX SS4

XX - CONTACT NO: 2-24

Contact: Brass+Tin, Green, PCB Straight
Rated Current: 18A (VDE), Rated Voltage: 250V (VDE)
Ambient Temperature: -40°C~+105°C



Series C09 1507 - 5,00mm Screw Clamp Terminal Block, Ver. Conductor
 Series C09 1587 - 5,08mm Screw Clamp Terminal Block, Ver. Conductor
 Series C09 1757 - 7,50mm Screw Clamp Terminal Block, Ver. Conductor
 Series C09 1107 - 10,00mm Screw Clamp Terminal Block, Ver. Conductor

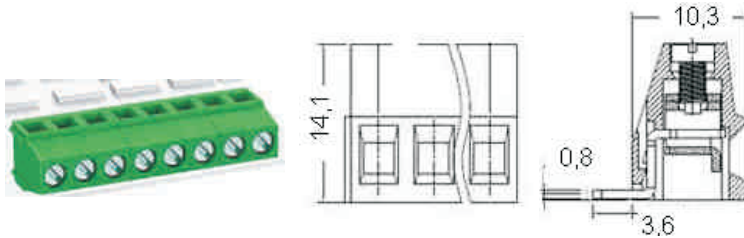

SM C09 1507 XX RS4
 SM C09 1587 XX RS4
 SM C09 1757 XX RS4
 SM C09 1107 XX RS4

XX - CONTACT NO: 2-24

Contact: Brass+Tin, Green, PCB Right
 Rated Current: 18A (VDE), Rated Voltage: 250V (VDE)
 Ambient Temperature: -40°C~+105°C

Series C09 1509 - 5,00mm Screw Clamp Terminal Block, Hor. Conductor
 Series C09 1589 - 5,08mm Screw Clamp Terminal Block, Hor. Conductor
 Series C09 1109 - 10,00mm Screw Clamp Terminal Block, Hor. Conductor

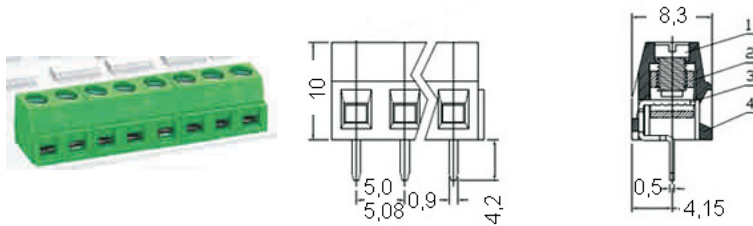

SM C09 1509 XX SS4
 SM C09 1589 XX SS4
 SM C09 1109 XX SS4

XX - CONTACT NO: 2-24

Contact: Brass+Tin, Green, PCB Straight
 Rated Current: 15A (VDE), Rated Voltage: 250V (VDE)
 Ambient Temperature: -40°C~+105°C

Series C09 15009 - 5,00mm Screw Clamp Terminal Block, Hor. Conductor
 Series C09 15809 - 5,08mm Screw Clamp Terminal Block, Hor. Conductor

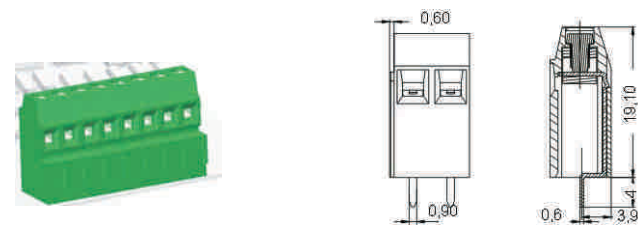

SM C09 15009 XX SS4-H
 SM C09 15809 XX SS4-H

XX - CONTACT NO: 2-24

Contact: Brass+Tin, Green, PCB Straight
 Rated Current: 15A (VDE), Rated Voltage: 250V (VDE)
 Ambient Temperature: -40°C~+105°C

Series C09 15009 - 5,00mm Screw Clamp Terminal Block, Hor. Conductor
 Series C09 15809 - 5,08mm Screw Clamp Terminal Block, Hor. Conductor

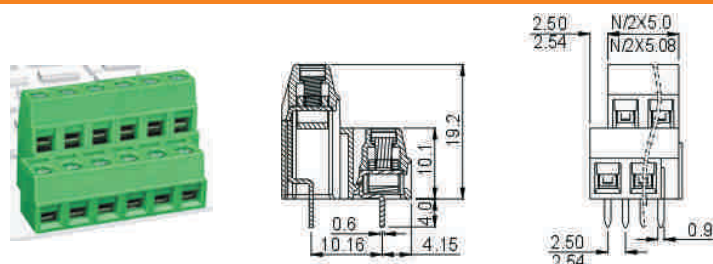

SM C09 15009 XX SS4-A
 SM C09 15809 XX SS4-A

XX - CONTACT NO: 2-24

Contact: Brass+Tin, Green, PCB Straight
 Rated Current: 15A (VDE), Rated Voltage: 250V (VDE)
 Ambient Temperature: -40°C~+105°C

Series C09 15009 - 5,00mm Screw Clamp Terminal Block, Hor. Conductor
Series C09 15809 - 5,08mm Screw Clamp Terminal Block, Hor. Conductor

SM C09 15009 XX SS4-B
SM C09 15809 XX SS4-B

XX - CONTACT NO: 2-24

Contact: Brass+Tin, Blue, PCB Straight
Rated Current:: 15A (VDE), Rated Voltage: 250V (VDE)
Ambient Temperature: -40°C~+105°C

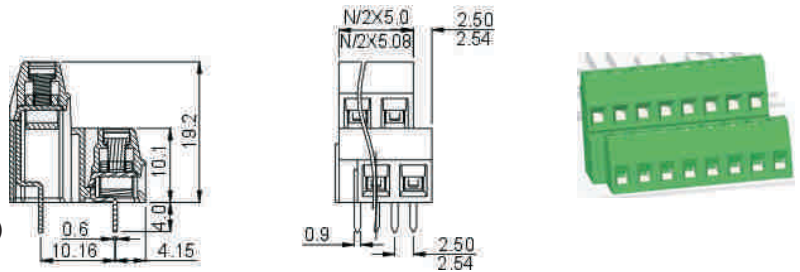

Series C09 15010 - 5,00mm Screw Clamp Terminal Block, Hor. Conductor
Series C09 15810 - 5,08mm Screw Clamp Terminal Block, Hor. Conductor

SM C09 15010 XX SS4-H
SM C09 15810 XX SS4-H

XX - CONTACT NO: 2-24

Contact: Brass+Tin, Green, PCB Straight
Rated Current:: 18A (VDE), Rated Voltage: 250V (VDE)
Ambient Temperature: -40°C~+105°C



Series C09 15010 - 5,00mm Screw Clamp Terminal Block, Hor. Conductor
Series C09 15810 - 5,08mm Screw Clamp Terminal Block, Hor. Conductor

SM C09 15010 XX SS4-A
SM C09 15810 XX SS4-A

XX - CONTACT NO: 2-24

Contact: Brass+Tin, Green, PCB Straight
Rated Current:: 18A (VDE), Rated Voltage: 250V (VDE)
Ambient Temperature: -40°C~+105°C

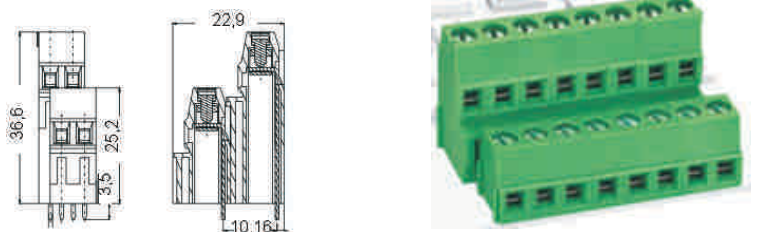

Series C09 15010 - 5,00mm Screw Clamp Terminal Block, Hor. Conductor
Series C09 15810 - 5,08mm Screw Clamp Terminal Block, Hor. Conductor

SM C09 15010 XX SS4-B
SM C09 15810 XX SS4-B

XX - CONTACT NO: 2-24

Contact: Brass+Tin, Green, PCB Straight
Rated Current:: 18A (VDE), Rated Voltage: 250V (VDE)
Ambient Temperature: -40°C~+105°C

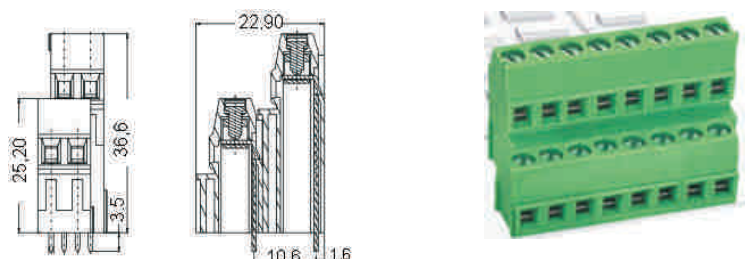

Series C09 15010 - 5,00mm Screw Clamp Terminal Block, Hor. Conductor
Series C09 15810 - 5,08mm Screw Clamp Terminal Block, Hor. Conductor

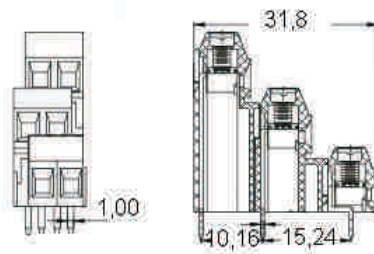

SM C09 15010 XX SS4-A3
SM C09 15810 XX SS4-A3

XX - CONTACT NO: 2-24

Contact: Brass+Tin, Green, PCB Straight
Rated Current: 18A (VDE), Rated Voltage: 250V (VDE)
Ambient Temperature: -40°C~+105°C

Series C09 15013 - 5,00mm Screw Clamp Terminal Block, 45° Conductor
Series C09 15813 - 5,08mm Screw Clamp Terminal Block, 45° Conductor

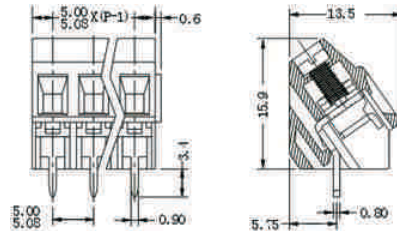
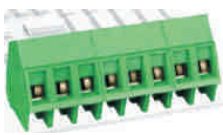

SM C09 15013 XX VS4
SM C09 15813 XX VS4

XX - CONTACT NO: 2-24

Contact: Brass+Tin, Green, PCB 45° Angle
Rated Current: 18A (VDE), Rated Voltage: 250V (VDE)
Ambient Temperature: -40°C~+105°C

Series C09 15016 - 5,00mm Screw Clamp Terminal Block, Hor. Conductor
Series C09 17516 - 7,50mm Screw Clamp Terminal Block, Hor. Conductor
Series C09 11016 - 10,00mm Screw Clamp Terminal Block, Hor. Conductor

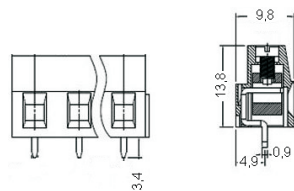

SM C09 15016 XX SS4
SM C09 17516 XX SS4
SM C09 11016 XX SS4

XX - CONTACT NO: 2-24

Contact: Brass+Tin, Green, PCB Straight
Rated Current: 18A (VDE), Rated Voltage: 250V (VDE)
Ambient Temperature: -40°C~+105°C

Series C09 15016 - 5,00mm Screw Clamp Terminal Block, Ver. Conductor
Series C09 17516 - 7,50mm Screw Clamp Terminal Block, Ver. Conductor
Series C09 11016 - 10,00mm Screw Clamp Terminal Block, Ver. Conductor



SM C09 15016 XX RS4
SM C09 17516 XX RS4
SM C09 11016 XX RS4

XX - CONTACT NO: 2-24

Contact: Brass+Tin, Green, PCB Straight
Rated Current: 18A (VDE), Rated Voltage: 250V (VDE)
Ambient Temperature: -40°C~+105°C

Series C09 15017 - 5,00mm Screw Clamp Terminal Block, Hor. Conductor
 Series C09 15817 - 5,08mm Screw Clamp Terminal Block, Hor. Conductor
 Series C09 17517 - 7,50mm Screw Clamp Terminal Block, Hor. Conductor
 Series C09 17617 - 7,62mm Screw Clamp Terminal Block, Hor. Conductor

SM C09 15017 XX SS4
 SM C09 15817 XX SS4
 SM C09 17517 XX SS4
 SM C09 17617 XX SS4

XX - CONTACT NO: 2-24

Contact: Brass+Tin, Green, PCB Right
 Rated Current:: 20A (VDE), Rated Voltage: 250V (VDE)
 Ambient Temperature: -40°C~+105°C

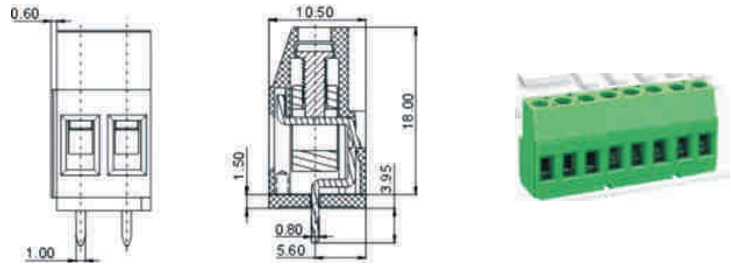

Series C09 15021 - 5,00mm Screw Clamp Terminal Block, 45° Conductor

SM C09 15021 XX VS2

XX - CONTACT NO: 2-24

Contact: Brass+Tin, Blue, PCB 45° Angle
 Rated Current:: 18A (VDE), Rated Voltage: 250V (VDE)
 Ambient Temperature: -40°C~+105°C

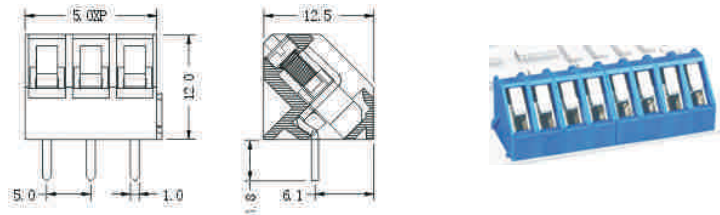

Series C09 15026 - 5,00mm Screw Clamp Terminal Block, Hor. Conductor

SM C09 15026 XX SS4

XX - CONTACT NO: 2-24

Contact: Brass+Tin, Green, PCB Straight
 Rated Current:: 24A (VDE), Rated Voltage: 250V (VDE)
 Ambient Temperature: -40°C~+105°C

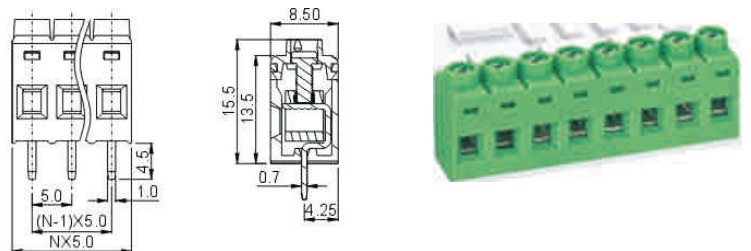

Series C09 15026 - 5,00mm Screw Clamp Terminal Block, Ver. Conductor

SM C09 15026 XX RS4

XX - CONTACT NO: 2-24

Contact: Brass+Tin, Green, PCB Right
 Rated Current:: 24A (VDE), Rated Voltage: 250V (VDE)
 Ambient Temperature: -40°C~+105°C

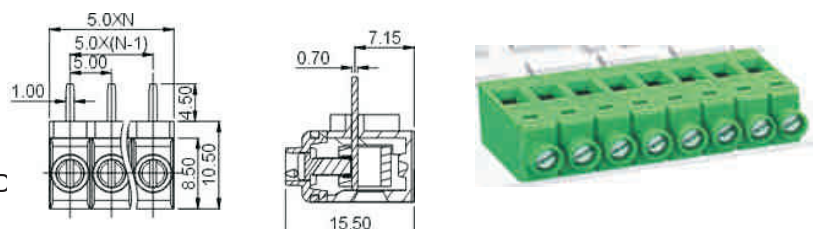

Series C09 15026 - 5,00mm Screw Clamp Terminal Block

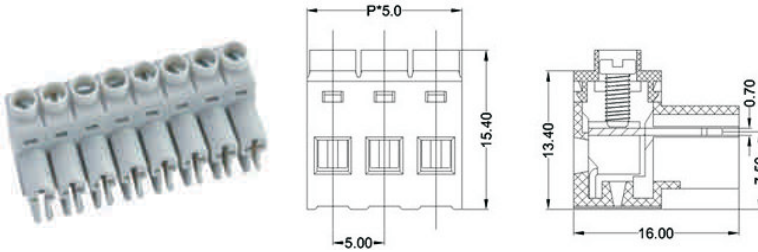

SM C09 15026 XX T

XX - CONTACT NO: 2-24

Contact: Brass+Tin, Grey,
Rated Current: 24A (VDE), Rated Voltage: 250V (VDE)
Ambient Temperature: -40°C~+105°C

Series C09 15026 - 5,00mm Screw Clamp Terminal Block

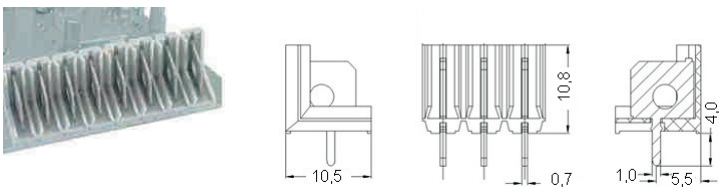

SM C09 15026 XX L

XX - CONTACT NO: 2-24

Contact: Brass+Tin, Grey
Rated Current: 24A (VDE), Rated Voltage: 250V (VDE)
Ambient Temperature: -40°C~+105°C

Series C09 11630 - 10,16mm Screw Clamp Terminal Block, Hor. Conductor

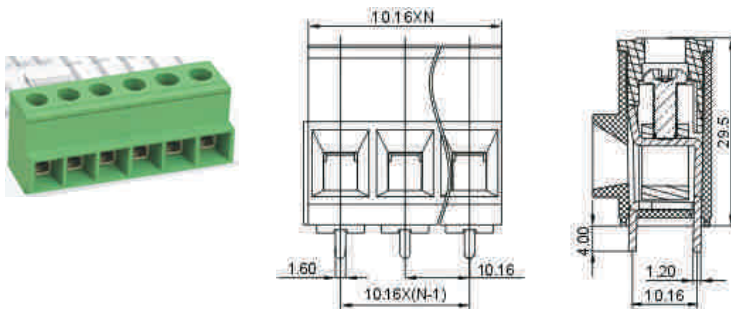

SM C09 11630 XX SS4

XX - CONTACT NO: 2-24

Contact: Brass+Tin, Green, PCB Straight
Rated Current: 57A (VDE), Rated Voltage: 750V (VDE)
Ambient Temperature: -40°C~+105°C

Series C09 11631 - 10,16mm Screw Clamp Terminal Block, Hor. Conductor

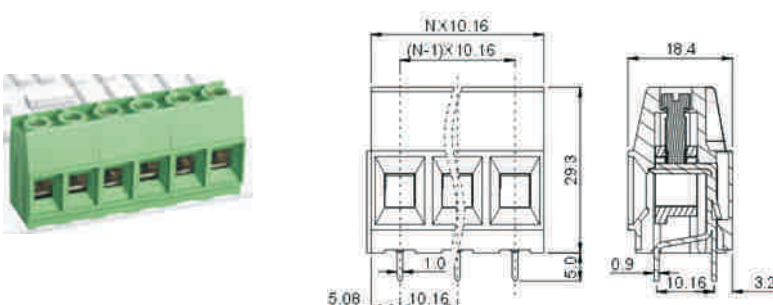

SM C09 11631 XX SS4

XX - CONTACT NO: 2-24

Contact: Brass+Tin, Green, PCB Straight
Rated Current: 65A (VDE), Rated Voltage: 1000V (VDE)
Ambient Temperature: -40°C~+105°C

Series C09 11532 - 15,00mm Screw Clamp Terminal Block, Hor. Conductor

SM C09 11532 XX SS4

XX - CONTACT NO: 2-24

Contact: Brass+Tin, Green, PCB Straight
Rated Current:: 115A (VDE), Rated Voltage: 1000V (VDE)
Ambient Temperature: -40°C~+105°C

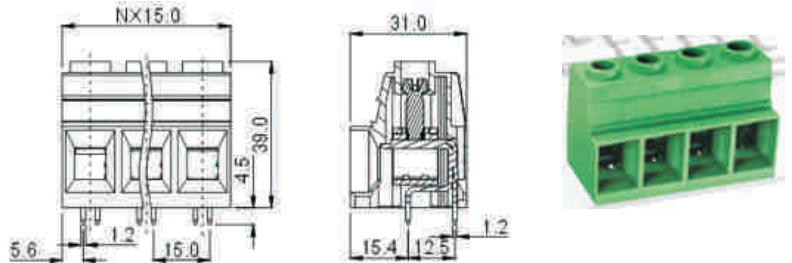

Series C09 11532 - 15,00mm Screw Clamp Terminal Block, Ver. Conductor

SM C09 11532 XX SS4-W

XX - CONTACT NO: 2-24

Contact: Brass+Tin, Green, PCB Straight
Rated Current:: 115A (VDE), Rated Voltage: 1000V (VDE)
Ambient Temperature: -40°C~+105°C

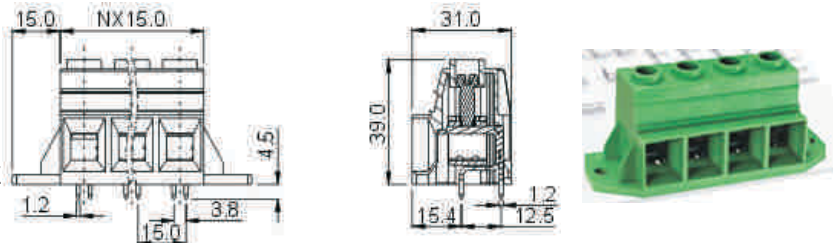

Series C09 11634 - 10,16mm Screw Clamp Terminal Block, Hor. Conductor

SM C09 11634 XX SS4

XX - CONTACT NO: 2-24

Contact: Brass+Tin, Green, PCB Straight
Rated Current:: 65A (VDE), Rated Voltage: 1000V (VDE)
Ambient Temperature: -40°C~+105°C

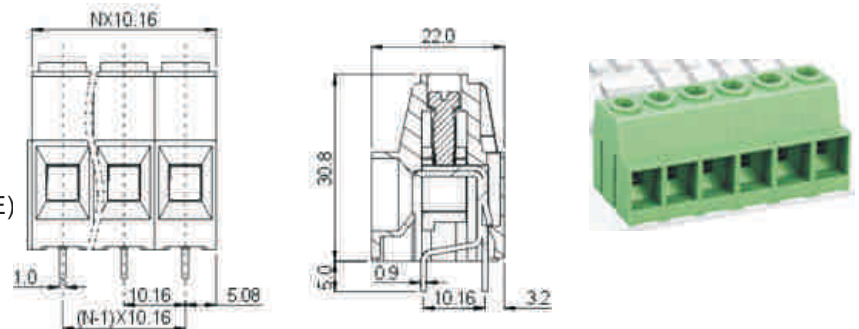

Series C09 19536 - 9,50mm Screw Clamp Terminal Block, Hor. Conductor

SM C09 19536 XX SS4

XX - CONTACT NO: 2-24

Contact: Brass+Tin, Green, PCB Straight
Rated Current:: 26A (VDE), Rated Voltage: 750V (VDE)
Ambient Temperature: -40°C~+105°C

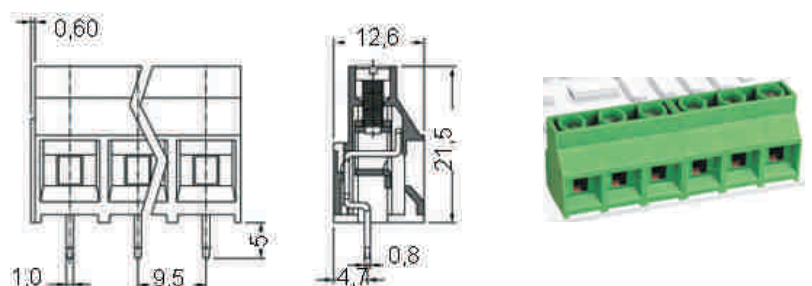

Series C09 2355 - 3,50mm Wire Protector Terminal Block, Hor. Conductor
Series C09 2705 - 7,00mm Wire Protector Terminal Block, Hor. Conductor

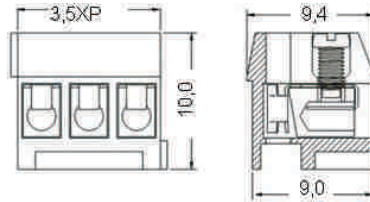
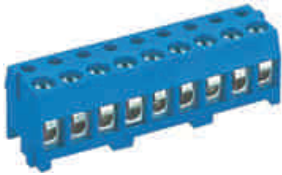

SM C09 2355 XX HW2
SM C09 2705 XX HW2

XX - CONTACT NO: 2-24

Contact: Brass+Tin, Blue, Header Mounted
Rated Current:: 8A (VDE), Rated Voltage: 250V (VDE)
Ambient Temperature: -40°C~+105°C

Series C09 2355 - 3,50mm Header for Wire Protector Terminal Block

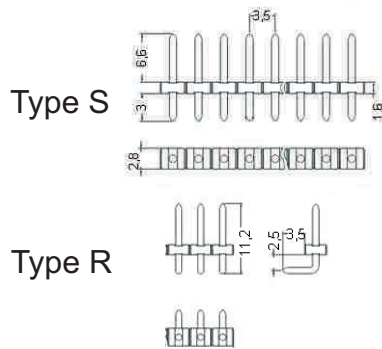

SM C09 2355 XX S
SM C09 2355 XX R

XX - CONTACT NO: 2-24

Contact: Brass+Tin
Rated Current:: 12A (VDE), Rated Voltage: 250V (VDE)
Ambient Temperature: -40°C~+105°C

Series C09 23512 - 3,50mm Wire Protector Terminal Block, Ver. Conductor
Series C09 23612 - 3,96mm Wire Protector Terminal Block, Ver. Conductor

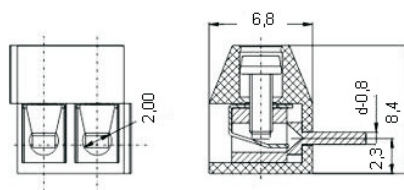

SM C09 23512 XX RW4
SM C09 23612 XX RW4

XX - CONTACT NO: 2-24

Contact: Brass+Tin, Green, PCB Right
Rated Current:: 10A (VDE), Rated Voltage: 130V (VDE)
Ambient Temperature: -40°C~+105°C

Series C09 23512 - 3,50mm Wire Protector Terminal Block, Hor. Conductor
Series C09 23612 - 3,96mm Wire Protector Terminal Block, Hor. Conductor

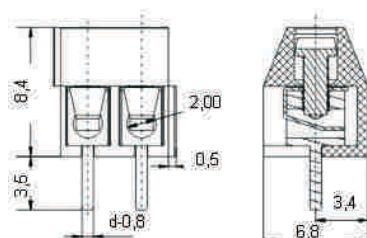

SM C09 23512 XX SW4
SM C09 23612 XX SW4

XX - CONTACT NO: 2-24

Contact: Brass+Tin, Green, PCB Straight
Rated Current:: 10A (VDE), Rated Voltage: 130V (VDE)
Ambient Temperature: -40°C~+105°C

Series C09 2502 - 5,00mm Wire Protector Terminal Block, Ver. Conductor
 Series C09 2582 - 5,08mm Wire Protector Terminal Block, Ver. Conductor
 Series C09 2102 - 10,00mm Wire Protector Terminal Block, Ver. Conductor

SM C09 2502 XX RW3
 SM C09 2582 XX RW3
 SM C09 2102 XX RW3

XX - CONTACT NO: 2-24

Contact: Brass+Tin, Black, PCB Right
 Rated Current:: 17.5A (VDE), Rated Voltage: 250V (VDE)
 Ambient Temperature: -40°C~+105°C

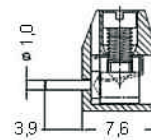
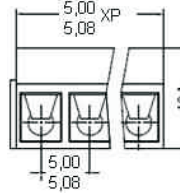

Series C09 2502 - 5,00mm Wire Protector Terminal Block, Hor. Conductor
 Series C09 2582 - 5,08mm Wire Protector Terminal Block, Hor. Conductor
 Series C09 2102 - 10,00mm Wire Protector Terminal Block, Hor. Conductor

SM C09 2502 XX SW3
 SM C09 2582 XX SW3
 SM C09 2102 XX SW3

XX - CONTACT NO: 2-24

Contact: Brass+Tin, Black, PCB Straight
 Rated Current:: 17.5A (VDE), Rated Voltage: 250V (VDE)
 Ambient Temperature: -40°C~+105°C

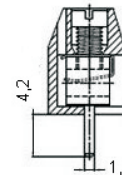
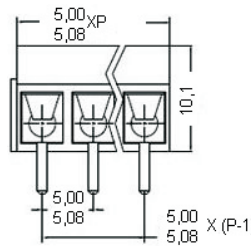

Series C09 2503 - 5,00mm Wire Protector Terminal Block, Hor. Conductor
 Series C09 2753 - 7,50mm Wire Protector Terminal Block, Hor. Conductor
 Series C09 2103 - 10,00mm Wire Protector Terminal Block, Hor. Conductor

SM C09 2503 XX SW3
 SM C09 2753 XX SW3
 SM C09 2109 XX SW3

XX - CONTACT NO: 2-24

Contact: Brass+Tin, Black, PCB Straight
 Rated Current:: 20A (VDE), Rated Voltage: 450V (VDE)
 Ambient Temperature: -40°C~+105°C

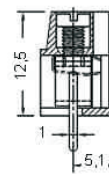
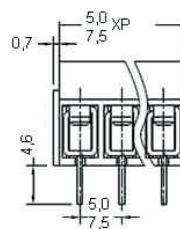

Series C09 2505 - 5,00mm Wire Protector Terminal Block, Ver. Conductor
 Series C09 2105 - 10,00mm Wire Protector Terminal Block, Ver. Conductor

SM C09 2505 XX HW3
 SM C09 2105 XX HW3

XX - CONTACT NO: 2-24

Contact: Brass+Tin, Black, Header Mounted
 Rated Current:: 12A (VDE), Rated Voltage: 250V (VDE)
 Ambient Temperature: -40°C~+105°C

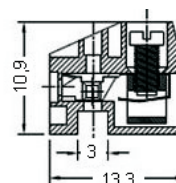
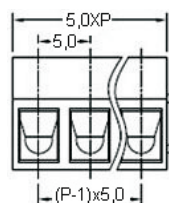

Series C09 2505 - 5,00mm Header for Wire Protector Terminal Block

Series C09 2105 - 10,00mm Header for Wire Protector Terminal Block

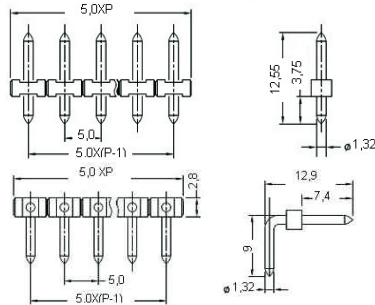

SM C09 2505 XX R
SM C09 2505 XX S
SM C09 2105 XX R
SM C09 2105 XX S

XX - CONTACT NO: 2-24

Contact: Brass+Tin
Rated Current: 12A (VDE), Rated Voltage: 250V (VDE)
Ambient Temperature: -40°C~+105°C

Series C09 2506 - 5,00mm Wire Protector Terminal Block - Hor. Conductor

Series C09 2756 - 7,50mm Wire Protector Terminal Block - Hor. Conductor

Series C09 2106 - 10,00mm Wire Protector Terminal Block - Hor. Conductor

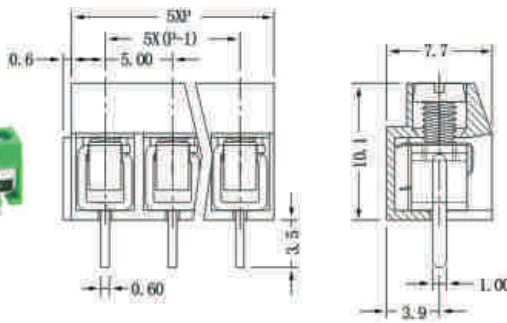
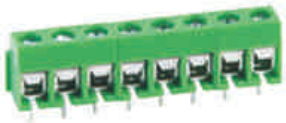

SM C09 2506 XX SW4
SM C09 2756 XX SW4
SM C09 2106 XX SW4

XX - CONTACT NO: 2-24

Contact: Brass+Tin, Green, PCB Straight
Rated Current: 18A (VDE), Rated Voltage: 450V (VDE)
Ambient Temperature: -40°C~+105°C

Series C09 25018 - 5,00mm Wire Protector Terminal Block, Ver. Conductor

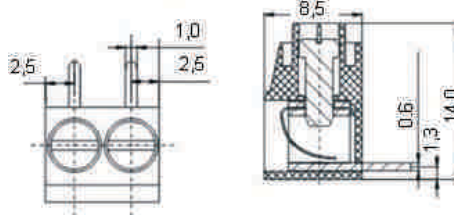
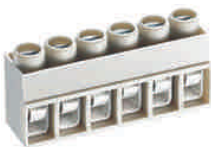

SM C09 25018 XX RW1

XX - CONTACT NO: 2-24

Contact: Brass+Tin, Grey, PCB Right
Rated Current: 22A (VDE), Rated Voltage: 250V (VDE)
Ambient Temperature: -40°C~+105°C

Series C09 25018 - 5,00mm Wire Protector Terminal Block, Hor. Conductor

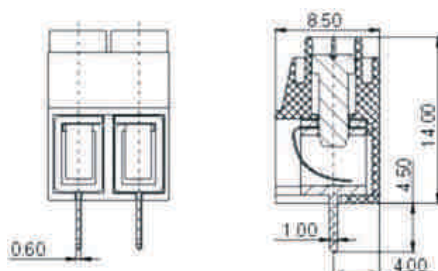

SM C09 25018 XX SW1

XX - CONTACT NO: 2-24

Contact: Brass+Tin, Grey, PCB Straight
Rated Current: 22A (VDE), Rated Voltage: 250V (VDE)
Ambient Temperature: -40°C~+105°C

Series C09 25020 - 5,00mm Wire Protector Terminal Block, Hor. Conductor

SM C09 25020 XX SW3

XX - CONTACT NO: 2-24

Contact: Brass+Tin, Black, PCB Straight
Rated Current: 22A (VDE), Rated Voltage: 250V (VDE)
Ambient Temperature: -40°C~+105°C

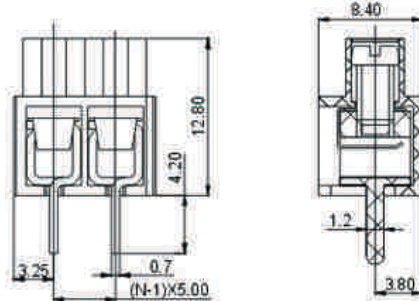

Series C09 25022 - 5,00mm Wire Protector Terminal Block, Hor. Conductor
Series C09 21022 - 10,00mm Wire Protector Terminal Block, Hor. Conductor

SM C09 25022 XX SW3
SM C09 21022 XX SW3

XX - CONTACT NO: 2-24

Contact: Brass+Tin, Black, PCB Straight
Rated Current: 20A (VDE), Rated Voltage: 300V (VDE)
Ambient Temperature: -40°C~+105°C

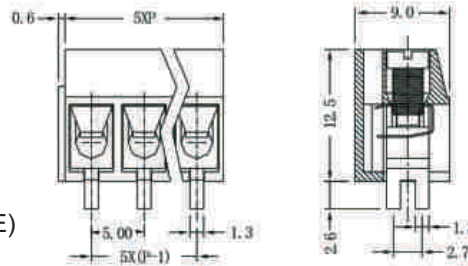

Series C09 25023 - 5,00mm Wire Protector Terminal Block, Hor. Conductor
Series C09 21023 - 10,00mm Wire Protector Terminal Block, Hor. Conductor

SM C09 25023 XX SW1
SM C09 21023 XX SW1

XX - CONTACT NO: 2-24

Contact: Brass+Tin, Grey, PCB Straight
Rated Current: 24A (VDE), Rated Voltage: 450V (VDE)
Ambient Temperature: -40°C~+105°C

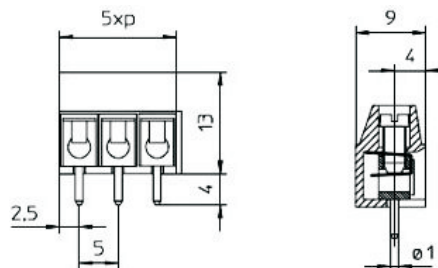

Series C09 250320 - 5,00mm Wire Protector Terminal Block, 45° Conductor
Series C09 210320 - 10,00mm Wire Protector Terminal Block, 45° Conductor

SM C09 250320 XX VW3
SM C09 210320 XX VW3

XX - CONTACT NO: 2-24

Contact: Brass+Tin, Black, PCB 45° Angle
Rated Current: 20A (VDE), Rated Voltage: 300V (VDE)
Ambient Temperature: -40°C~+105°C

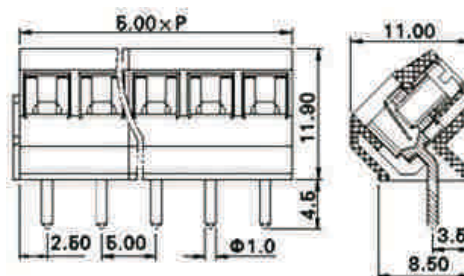

Series C09 3252 - 2,50mm Spring Terminal Block, Ver. Conductor
Series C09 3502 - 5,00mm Spring Terminal Block, Ver. Conductor

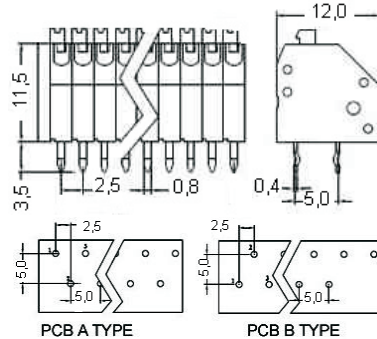

SM C09 3252 XX SC1Y
SM C09 3502 XX SC1Y

XX - CONTACT NO: 2-24
Y - A: Typee A; B: Typee B

Contact: Brass+Tin, Grey, PCB Straight
Rated Current:: 7A (IEC), Rated Voltage: 250V (IEC)
Ambient Temperature: -40°C~+105°C

Series C09 3243 - 2,54mm Spring Terminal Block, Hor. Conductor

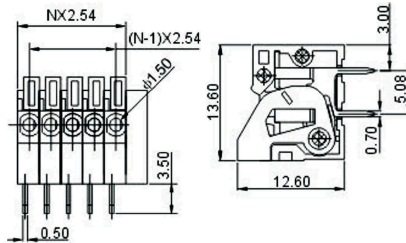
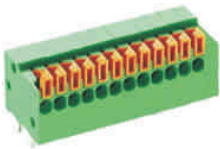

SM C09 3243 XX RC4

XX - CONTACT NO: 2-24

Contact: Brass+Tin, Green, PCB Right
Rated Current:: 6A (IEC), Rated Voltage: 130V(IEC)
Ambient Temperature: -40°C~+105°C

Series C09 3243 - 2,54mm Spring Terminal Block, Ver. Conductor

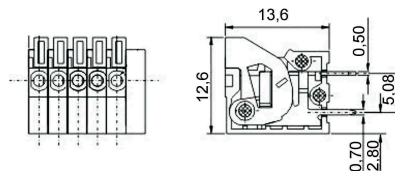
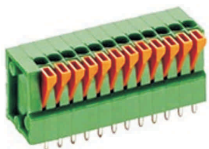

SM C09 3243 XX SC4

XX - CONTACT NO: 2-24

Contact: Brass+Tin, Green, PCB Straight
Rated Current:: 6A (IEC), Rated Voltage: 130V(IEC)
Ambient Temperature: -40°C~+105°C

Series C09 3258 - 2,50mm Spring Terminal Block, Hor. Conductor
Series C09 3248 - 2,54mm Spring Terminal Block, Hor. Conductor

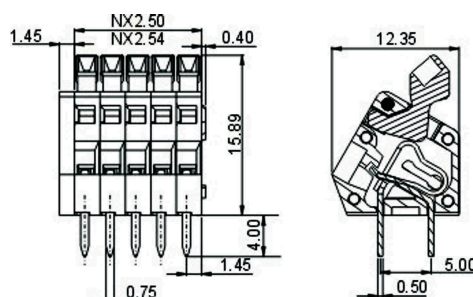
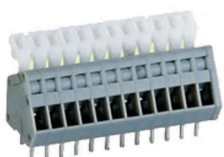

SM C09 3258 XX SC1
SM C09 3248 XX SC1

XX - CONTACT NO: 2-24

Contact; Brass+Tin, Grey, PCB Right
Rated Current:: 6A (IEC), Rated Voltage: 130V (IEC)
Ambient Temperature: -40°C~+105°C

Series C09 32416 - 2,54mm Spring Terminal Block, Hor. Conductor

SM C09 32416 XX SC1

XX - CONTACT NO: 2-24

Contact: Brass+Tin, Grey, PCB Straight
Rated Current: 6A (IEC), Rated Voltage: 130V (IEC)
Ambient Temperature: -40°C~+105°C

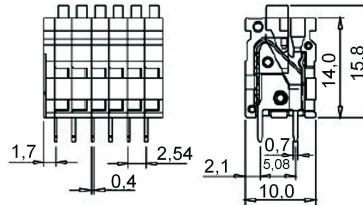

Series C09 32416 - 2,54mm Spring Terminal Block, Ver. Conductor

SM C09 32416 XX RC1

XX - CONTACT NO: 2-24

Contact: Brass+Tin, Grey, PCB Right
Rated Current: 6A (IEC), Rated Voltage: 130V (IEC)
Ambient Temperature: -40°C~+105°C

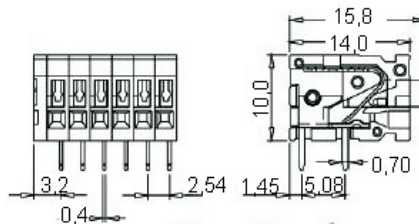

Series C09 3351 - 3,50mm Spring Terminal Block, Hor. Conductor

Series C09 3381 - 3,81mm Spring Terminal Block, Hor. Conductor

Series C09 3501 - 5,00mm Spring Terminal Block, Hor. Conductor

Series C09 3581 - 5,08mm Spring Terminal Block, Hor. Conductor

SM C09 3351 XX SC1

SM C09 3381 XX SC1

SM C09 3501 XX SC1

SM C09 3581 XX SC1

XX - CONTACT NO: 2-24

Contact: Brass+Tin, Grey, PCB Straight
Rated Current: 15A (IEC), Rated Voltage: 250V (IEC)
Ambient Temperature: -40°C~+105°C

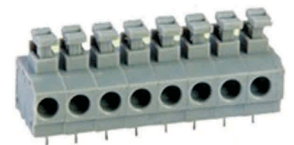
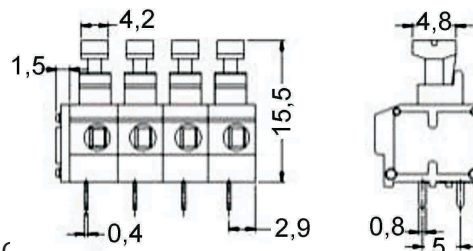

Series C09 3351R - 3,50mm Spring Terminal Block, Hor. Conductor

Series C09 3381R - 3,81mm Spring Terminal Block, Hor. Conductor

Series C09 3501R - 5,00mm Spring Terminal Block, Hor. Conductor

Series C09 3581R - 5,08mm Spring Terminal Block, Hor. Conductor

SM C09 3351R XX SC1

SM C09 3381R XX SC1

SM C09 3501R XX SC1

SM C09 3581R XX SC1

XX - CONTACT NO: 2-24

Contact: Brass+Tin, Grey, PCB Straight
Rated Current: 15A (IEC), Rated Voltage: 250V (IEC)
Ambient Temperature: -40°C~+105°C

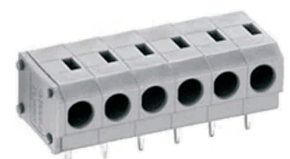
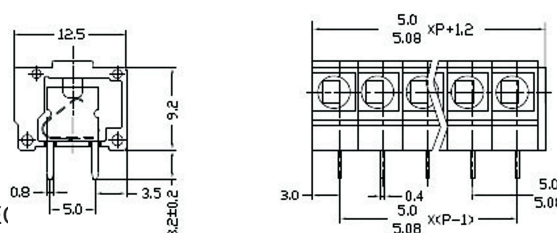

Series C09 3352 - 3,50mm Spring Terminal Block, Ver. Conductor
Series C09 3702 - 7,00mm Spring Terminal Block, Ver. Conductor

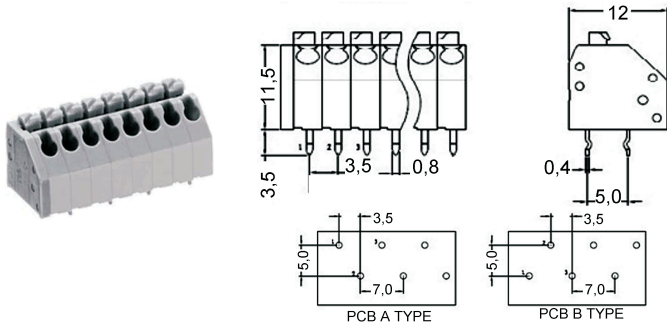

SM C09 3352 XX SC1Y
SM C09 3702 XX SC1Y

XX - CONTACT NO: 2-24
Y - A: Typee A; B: Typee B

Contact: Brass+Tin, Grey, PCB Straight
Rated Current:: 7A (IEC), Rated Voltage: 250V (IEC)
Ambient Temperature: -40°C~+105°C

Series C09 34045 - 4,00mm Spring Terminal Block, Hor. Conductor

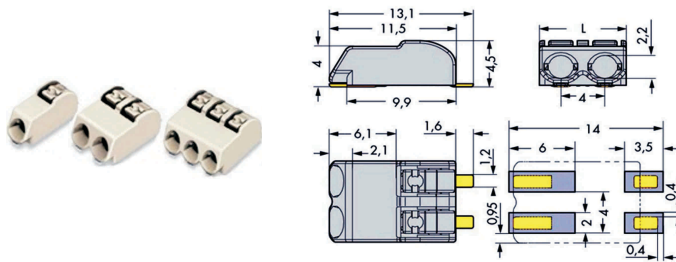

SM C09 34045 XX DCZ

XX - CONTACT NO: 2-24
Z - Colour = 3:Black, 6:Red, 8:White
Contact: Brass+Tin, SMT
Rated Current:: 9A, Rated Voltage: 300V
Ambient Temperature: -40°C~+105°C

Series C09 3584 - 5,08mm Spring Terminal Block, Hor. Conductor
Series C09 3764 - 7,62mm Spring Terminal Block, Hor. Conductor

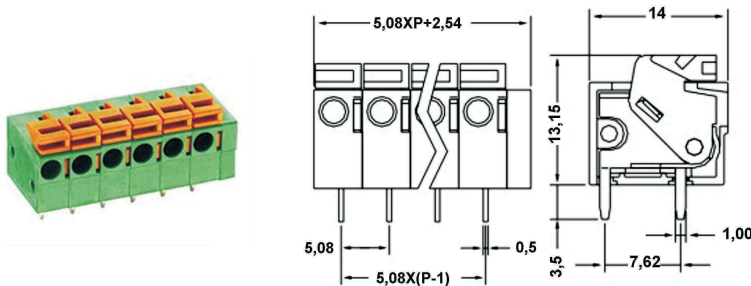

SM C09 3584 XX RC4
SM C09 3764 XX RC4

XX - CONTACT NO: 2-24

Contact: Brass+Tin, Green, PCB Right
Rated Current:: 15A (IEC), Rated Voltage: 250V (IEC)
Ambient Temperature: -40°C~+105°C

Series C09 3584 - 5,08mm Spring Terminal Block, Ver. Conductor
Series C09 3764 - 7,62mm Spring Terminal Block, Ver. Conductor

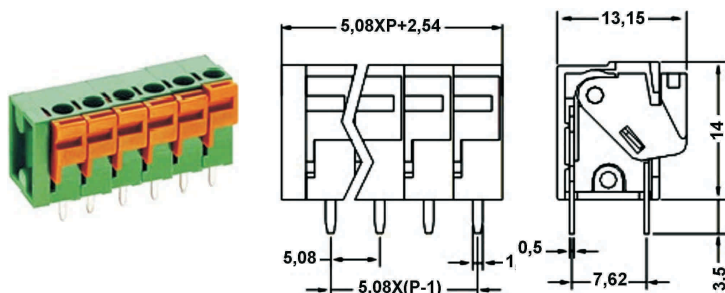

SM C09 3584 XX SC4
SM C09 3764 XX SC4

XX - CONTACT NO: 2-24

Contact; Brass+Tin, Green, PCB Straight
Rated Current:: 15A (IEC), Rated Voltage: 250V (IEC)
Ambient Temperature: -40°C~+105°C

Series C09 3509 - 5,00mm Spring Terminal Block, 45° Conductor

SM C09 3509 XX VC4-D

XX - CONTACT NO: 2-24

Contact: Brass+Tin, Green, PCB 45° Angle
Rated Current: 12A (IEC), Rated Voltage: 450V (IEC)
Ambient Temperature: -40°C~+105°C

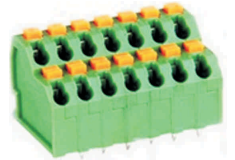
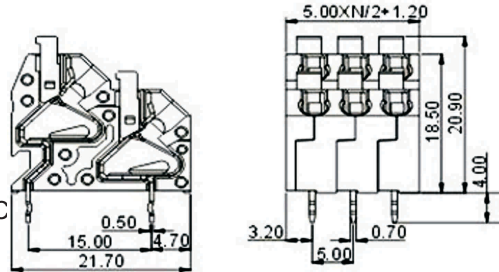

Series C09 3508 - 5,00mm Spring Terminal Block, 45° Conductor Series C09 3588 - 5,08mm Spring Terminal Block, 45° Conductor

SM C09 3508 XX VC1-D
SM C09 3588 XX VC1-D

XX - CONTACT NO: 2-24

Contact: Brass+Tin, Grey, PCB 45° Angle
Rated Current: 18A (IEC), Rated Voltage: 400V (IEC)
Ambient Temperature: -40°C~+105°C

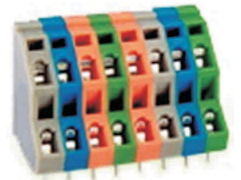
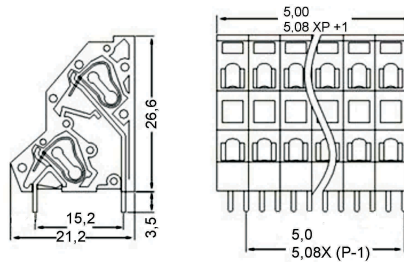

Series C09 3508 - 5,00mm Spring Terminal Block, 45° Conductor Series C09 3588 - 5,08mm Spring Terminal Block, 45° Conductor

SM C09 3508 XX VC1-T
SM C09 3588 XX VC1-T

XX - CONTACT NO: 2-24

Contact: Brass+Tin, Grey, PCB 45° Angle
Rated Current: 18A (IEC), Rated Voltage: 400V (IEC)
Ambient Temperature: -40°C~+105°C

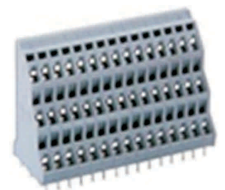
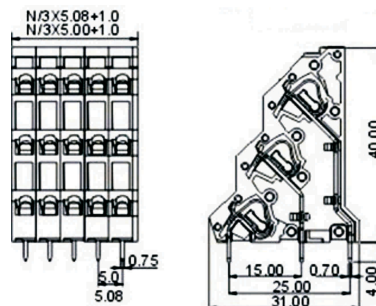

Series C09 3509 - 5,00mm Spring Terminal Block, Ver. Conductor

SM C09 3508 XX SC3

XX - CONTACT NO: 2-24

Contact: Brass+Tin, Black, PCB Straight
Rated Current: 18A (IEC), Rated Voltage: 400V (IEC)
Ambient Temperature: -40°C~+105°C

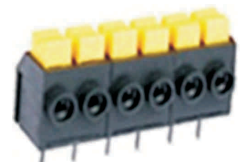
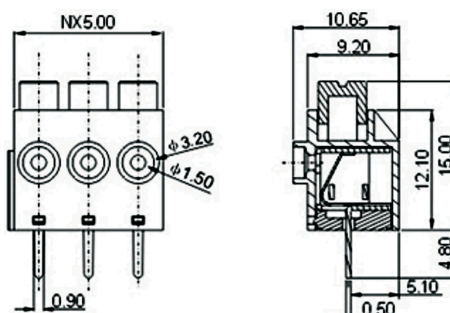

Series C09 35012 - 5,00mm Spring Terminal Block, Ver. Conductor
Series C09 35812 - 5,08mm Spring Terminal Block, Ver. Conductor

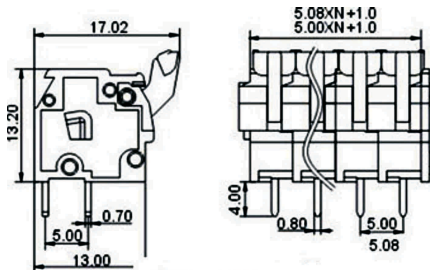
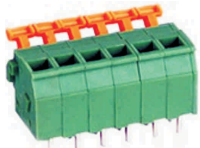

SM C09 35012 XX SC4
SM C09 35812 XX SC4

XX - CONTACT NO: 2-24

Contact: Brass+Tin, Green, PCB Straight
Rated Current:: 18A (IEC), Rated Voltage: 400V (IEC)
Ambient Temperature: -40°C~+105°C

Series C09 35013 - 5,00mm Spring Terminal Block, 45° Conductor
Series C09 35813 - 5,08mm Spring Terminal Block, 45° Conductor

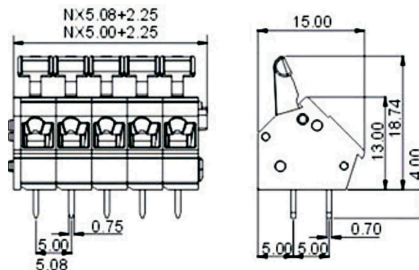
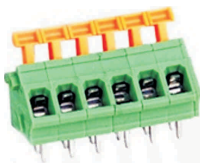

SM C09 35013 XX VC4
SM C09 35813 XX VC4

XX - CONTACT NO: 2-24

Contact: Brass+Tin, Green, PCB 45°Angle
Rated Current:: 18A (IEC), Rated Voltage: 400V (IEC)
Ambient Temperature: -40°C~+105°C

Series C09 35014 - 5,00mm Spring Terminal Block, 45° Conductor
Series C09 35814 - 5,08mm Spring Terminal Block, 45° Conductor

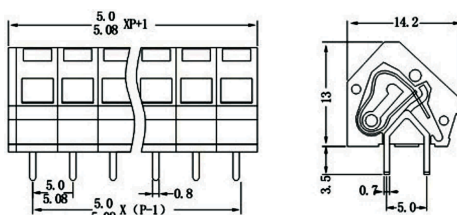

SM C09 35014 XX VC1
SM C09 35814 XX VC1

XX - CONTACT NO: 2-24

Contact: Brass+Tin, Grey, PCB 45°Angle
Rated Current:: 18A (IEC), Rated Voltage: 400V (IEC)
Ambient Temperature: -40°C~+105°C

Series C09 3586 - 5,08mm Spring Terminal Block, 45° Conductor
Series C09 3766 - 7,62mm Spring Terminal Block, 45° Conductor

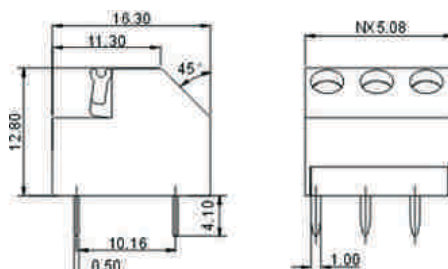

SM C09 3586 XX VC1
SM C09 3766 XX VC1

XX - CONTACT NO: 2-24

Contact: Brass+Tin, Grey, PCB 45°Angle
Rated Current:: 15A (IEC), Rated Voltage: 250V (IEC)
Ambient Temperature: -40°C~+105°C

Series C09 33018 - 3,00mm Spring Terminal Block

SM C09 33018 XX WC1

XX - CONTACT NO: 2,3,4,5,8

Contact: Brass+Tin, Green, Wire to Wire
Rated Current:: 18A (IEC), Rated Voltage: 400V (IEC)
Ambient Temperature: -40°C~+105°C
Strip Length: 10-13mm

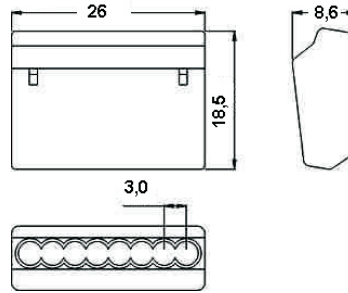

Series C09 38020 01 Spring Terminal Block

SM C09 38020 01 WC1

Contact: Brass+Tin, Grey, Wire to Wire
Rated Current:: 24A (IEC), Rated Voltage: 450V (IEC)
Ambient Temperature: -40°C~+105°C

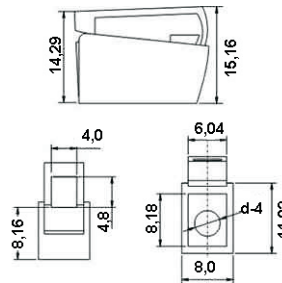

Series C09 39521 01 Spring Terminal Block - Double entry

SM C09 39521 02 WC1

Contact: Brass+Tin, Grey, Wire to Wire
Rated Current:: 24A (IEC), Rated Voltage: 450V (IEC)
Ambient Temperature: -40°C~+105°C

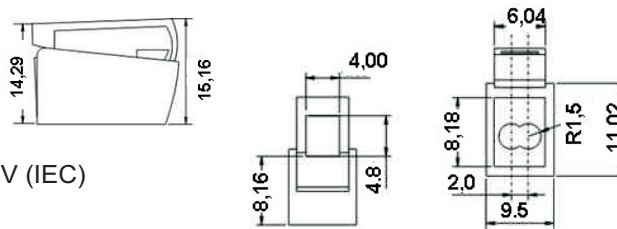

Series C09 38022 - Spring Terminal Block

SM C09 38022 01 WC1

Contact: Brass+Tin, Grey, Wire to Wire
Rated Current:: 24A (IEC), Rated Voltage: 450V (IEC)
Ambient Temperature: -40°C~+105°C

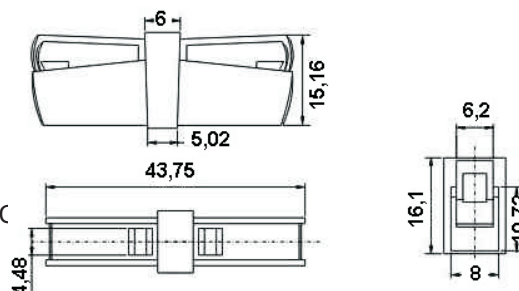

Series C09 35630 - 5,60mm Spring Terminal Block

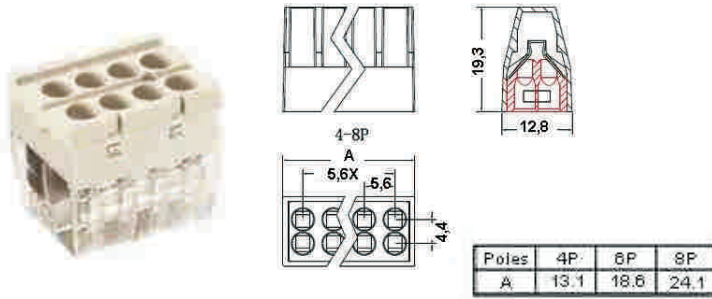

SM C09 35630 XX WC

XX - CONTACT NO: 2,4,6,8

Contact: Brass+Tin, Green, Wire to Wire
Rated Current: 24A (IEC), Rated Voltage: 400V (IEC)
Ambient Temperature: -40°C~+105°C
Strip length: 8-9mm

Series C09 35034- 5,00mm Spring Terminal Block



SM C09 35034 XX WC

XX - CONTACT NO: 2,3,5

Contact: Brass+Tin, Green, Wire to Wire
Rated Current: 24A (IEC), Rated Voltage: 400V (IEC)
Ambient Temperature: -40°C~+105°C
Strip length: 8-9mm

- Series C09 77601 - 7,62mm Barrier Terminal Block
- Series C09 78201 - 8,25mm Barrier Terminal Block
- Series C09 79501 - 9,50mm Barrier Terminal Block
- Series C09 71001 - 10,00mm Barrier Terminal Block

Type: central pin

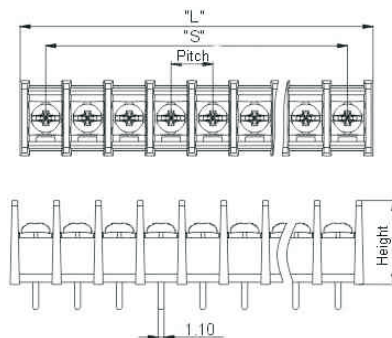

- SM C09 77601 XX Y, 15A
- SM C09 78201 XX Y, 20A
- SM C09 79501 XX Y, 25A
- SM C09 71001 XX Y, 32A
- SM C09 71101 XX Y, 32A

XX - CONTACT NO: 0 2-24
Y - C-Central pin, S-Side pin

Type: side pin



Solder pins: Brass, 1,0t/0,8t, Tin-Plated
Housing: Pa66 UL94V-0

SM C09 71020 03 1

Pitch: 10,00mm
300V/15A 0,50-4,00mm²



SM C09 71222 03 1

Pitch: 12,00mm
300V/15A 0,50-4,00mm²



SM C09 71022 02

Pitch: 10,00mm
300V/10A 0,50-6,00mm²



SM C09 71023 02

Pitch: 10,00mm
300V/10A-4,00mm²



SM C09 710210 XX

Pitch: 8,00; 10,00; 12,00mm
13,50; 14,50; 16,50mm

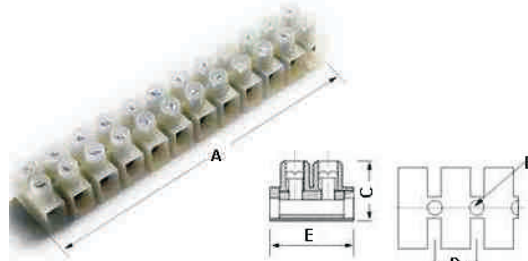

SM C09 710211 XX Y

Bakelite Materials
Pitch: 10,00; 12,00mm



Y - 1 = 5A;4mm²
Y - 2 = 6A;6mm²
Y - 3 = 15A;12mm²
Y - 4 = 30A;16mm²

SM C09 71021 02

Pitch: 10,00mm
300V/10A 4,00mm²



SM C09 71025 02

Pitch: 10,00mm
450V/24A 4,00mm²



SM C09 71025 02

Pitch: ---
250V/13A 0,50-2,50mm²



SM C09 75824 XX SY
SM C09 77624 XX SY
SM C09 71024 XX SY
Pitch: 5,08; 7,62; 10,16mm
300V/20A

SM C09 75824 XX RY
SM C09 77624 XX RY
SM C09 71024 XX RY
Pitch: 5,08; 7,62; 10,16mm
300V/20A

Y: Type
Type A: faston 6,3mm
Type B: faston 4,8mm
Type C: faston 2,8mm



Y: Type
Type A: faston 6,3mm
Type B: faston 4,8mm
Type C: faston 2,8mm



SM C09 71012 02

Pitch: 10,50mm
750V/24A 4,00-10,0mm²



SM C09 71917 01

Pitch: 19,00mm
750V/57A 4,00-10,00mm²



SM C09 71215 01

Pitch: 12,50mm
250V/24A 0,50-4,00mm²



SM C09 77514 XX

Pitch: 7,50mm
450V/32A 0,50-4,00mm²



SM C09 71313 01

Pitch: 13,00mm
250V/32A 0,75-4,00mm²



SM C09 77512 XX

Pitch: 7,50mm
250V/24A 0,50-2,50mm²



SM C09 71511 01

Pitch: 15,00mm
750V/41A 0,50-6,00mm²



SM C09 77510 XX

Pitch: 7,5mm
750V/32A 0,50-4,00mm²



SM C09 7751-description

Pitch: 4,50mm



SM C09 79517 03

Pitch: 9,50mm
250V/24A 0,5-2,5mm²



SM C09 77514 01

Pitch: 13,00mm
250V/10A 0,5-4,00mm²



SM C09 71918 01

Pitch: 13,00mm
750V/57A 4,0-10,00mm²



SM C09 775415 XX

Current: 15A; Wire Size:1,5mm²
3P/4P/5P/6P/8P/10P/12P



SM C09 710425 XX

Current: 25A; Wire Size:2,5mm²
3P/4P/5P/6P/8P/10P/12P



SM C09 710435 XX

Current: 35A; Wire Size:2,5mm²
3P/4P/5P/6P/8P/10P/12P



SM C09 715445 XX

Current: 45A; Wire Size:4mm²
3P/4P/5P/6P/8P/10P/12P



SM C09 715460 XX

Current: 60A; Wire Size:14mm²
3P/4P/5P/6P/12P



SM C09 7194100 XX

Current: 100A; Wire Size:22mm²
3P/4P/6P



SM C09 710510 03 Cer

Pitch: 10,00mm
450V/30A 0,20-4,00mm²



SM C09 711512 XX Cer

Pitch: 11,50mm
450V/24A 4,00mm²



SM C09 712513 XX Cer

Pitch: 12,50mm
450V/48A 0,20-6,00mm²



SM C09 714514 XX Cer

Pitch: 14,00mm
450V/57A 10,00mm²



SM C09 717517 03 Cer

Pitch: 17,00mm
450V/60A 10,00mm²



SM C09 718518 02 Cer

Pitch: 18,50mm
450V/60A 10,00mm²



SM C09 UK Series

Wire Size: 1.5 / 2.5 / 4 / 6 / 10 / 16 / 35 / 50 / 95 / 150mm²



SM C09 UK-PE Series

Wire Size: 1.5 / 2.5 / 4 / 6 / 10 / 16 / 35 / 50 / 95mm²



SM C09 UK-TW Series

Wire Size: 2.5 / 4 / 6mm²

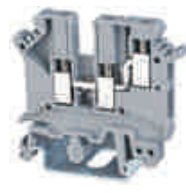

SM C09 UK-TW-PE Series

Wire Size: 2.5 / 4 / 6 mm²



SM C09 UDK Series

Wire Size: 2.5 / 4mm²



SM C09 ODK-PE Series

Wire Size: 2.5 / 4mm²

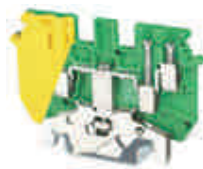

SM C09 UK4-HE Series

Wire Size: 4mm²



SM C09 UK10-DR Series

Wire Size: 16mm²



SM C09 UKK Series

Wire Size: 2.5 / 4mm²

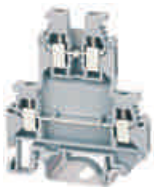

SM C09 UMT Series

Wire Size: 2.5 / 4mm²



SM C09 UK type Accessory



SM C09 Din Rail
Materials: Steel / Aluminium
C25, G32, TH15, TH35



SM C09 SAK Series

Wire Size: 1.5 / 2.5 / 4 / 6 / 10 / 16 / 35 / 70mm²

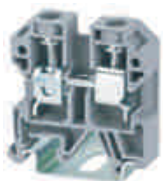

SM C09 EK Series

Wire Size: 1.5 / 2.5 / 4 / 6 / 10 / 16 / 35 / 70mm²

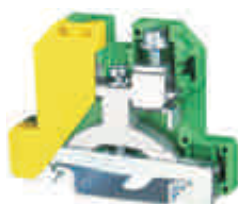

SM C09 SAK-4Q Series

Wire Size: 4mm²



SM C09 SAK type Accessory



SM C09 WS Series

Wire Size: 1.5 / 2.5 / 4 /
6 / 10 / 16 mm²



SM C09 WS-PE Series

Wire Size: 1.5 / 2.5 / 4 /
6 / 10 / 16 mm²



SM C09 WS-TW Series

Wire Size: 1.5 / 2.5 / 4 /
6 / 10 / 16 mm²



SM C09 WS-TW-PE Series

Wire Size: 1.5 / 2.5 / 4 /
6 / 10 / 16 mm²



SM C09 WS-DB Series

Wire Size: 4mm²
800V/6.3A



SM C09 WST-DB Series

Wire Size: 16 mm²
800V/10A



SM C09 WS-SD Series

Wire Size: 1.5 / 2.5 / 4 /
6 / 10 / 16 mm²



SM C09 WS-SD-PE Series

Wire Size: 1.5 / 2.5 / 4 /
6 / 10 / 16 mm²



SM C09 WS-TW-TA Series

Wire Size: 2.5 / 4mm²



SM C09 D-WS Series
SM C09 WS-TW Series

1.5; 2.5; 4; 6; 10; 16



SM C09 WHH-WS-DB S.

1.5; 2.5; 4



SM C09 DEK4 / 5 / 6

1.5; 2.5; 4



I.M. Housing SM H 23

Pitch: 17.5; 22.5; 35; 45mm

SM H 23-49



SM H 23-51



Int.M. Housing

SM H 23-59 Size 82x21
SM H 23-87 Size 126x37

SM H 23-87



I.M. Housing

SM H 802-25
SM H 802-40

SM H 802-40



Interface-Mould Housing

SM H 806-17.5; SM H 806-22.5
SM H 806-35; SM H 806-45

SM H 806-17.5



SM H 806-35



SM C09 35012 XX RC4 Part Numbering System

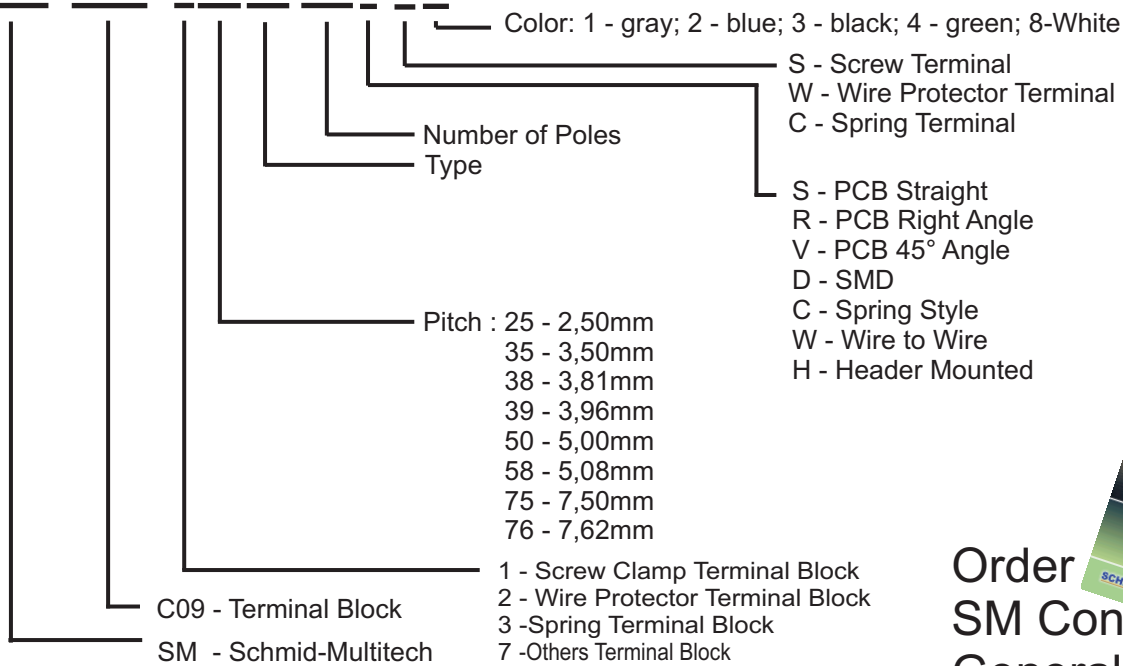

Order
**SM Connector
General Catalogue**



SCHMID-MULTITECH, GmbH
Weinbergstraße 60b, 93105 Tegernheim
Tel.: +49-9403-9510-0
info@schmid-multitech.de
www.schmid-multitech.de



SCHMID-MULTITECH, GmbH
Ot Ziemendorf, Dorfstraße 49g
49-39384-9848-0
info@schmid-multitech.de
www.schmid-multitech.de



ATD Elektronik, s.r.o.
Luženice 10, 344 01 Domažlice
tel.: +420 379 723 915
info@atd-elektronik.cz
www.atd-elektronik.cz



ABC Elektronik Sp. z o.o.
ul. Kolejowa 10, 38-300 Gorlice
tel.: +48 18 353-66-65
info@abcpol.pl
www.abcpol.pl



SCHMID-MULTITECH, s.r.o.
Podjavorinskej 5, 911 05 Trenčín
tel.: +421-32-7 440 186
mkovacik@smsk.sk
www.schmid-multitech.sk



ANGIELA ELEKTRONIK SRL
Str.Slanic Nr. 1 Ap3, 400413 Cluj-Napoca
tel.: +42-264-403-284
info@angiela-elektronik.ro
www.angiela-elektronik.ro



ADMM Kft.
Rumi u. 284, H-9700 Szombathely
tel.: +36-94 510-522
mail@admm.hu
www.admm.hu