



**PUSH PULL CONNECTORS
LEADING MANUFACTURER**

www.atd-shop.com



COMPANY PROFILE

Shenzhen MOCO Interconnect Co., Ltd is a high-tech enterprise with nearly a decade experience of developing, designing and manufacturing push-pull self-locking connectors. With a number of authoritative patents, MOCO can supply eco-friendly, high quality connectors and best cable assembly solutions for you. With 1600 square meters premises for research & development and production. Under the excellent management and great efforts of innovation for many years by MOCO team, we have developed a lot of popular products such as precision circular push-pull connector and YLH connector. MOCO connectors are of stable performance and attractive appearance which are interchangeable with international brands, widely used in the fields of measurement, medical, audio-video, military, navigation, security, aviation, industrial control, automotive and power etc.

We have got 10 utility patents, 2 trade mark and 8 design patents, and passed on UL,CE,RoHS and ISO9001:2015 certification. MOCO provides professional technology and service guarantee for your choice.



PRODUCTION EQUIPMENTS

MOCO imported modern high precision and high efficiency professional processing equipment, including STAR CNC machines imported from Japan, contact optical sorting machine, injection machine and grinding machine, and supplemented with professionals and management team. To provide best products with costs-effectiveness for our customer, we are committed to optimize process and improve productivity at the forefront of production line.



TESTING EQUIPMENT

"Quality first, reputation upmost, quality products and continuous improvement" is our quality policy. Every aspect of production, we are strictly follow the requirements of the quality policy. Each step we are constantly strive for excellence. As we know, for precision machinery, minor errors will cause huge losses.

MOCO implement comprehensive quality management, strictly implement the requirements of ISO9001:2015 quality management system. Our team upholds "quality first, meets customers requirements, continuous improvement and going concern" quality policy, try our best to provide excellent products and services.



Plugging force tester



Microscope



Voltage tester



DC low resistance tester



Servo tensile testing machine



DC power supply



Insulation Resistance Tester



Cable tester



Salt spray chamber



Wire bending test machine



Vision Measuring System(VMS)

APPLICATION

MOCO connectors widely used in the fields of military, medical, measurement, audio-video, automotive, Industrial Electronics and instruments etc. Products with small size and light weight, can be flexible mounted on varieties of portable external interfaces, and have great technical performances to satisfy the requirements of current or signal connection.



- ⊙ Diagnostic equipment
- ⊙ Surgical Instruments
- ⊙ Therapeutic application
- ⊙ Medical imaging
- ⊙ Cardiac aids
- ⊙ Disposable equipment



- ⊙ Studio and outside broadcast
- ⊙ TV and Movie
- ⊙ HD and SD cameras
- ⊙ Remote camera control
- ⊙ Drone
- ⊙ Communication systems
- ⊙ Monitoring equipment



- ⊙ Avionics
- ⊙ Maritime
- ⊙ Automobile
- ⊙ Railway
- ⊙ Transport
- ⊙ Tsting and measurement



- ⊙ Racing
- ⊙ Submarine industry
- ⊙ Weatherproof application
- ⊙ Robots



- ⊙ Sensor
- ⊙ Data acquisition
- ⊙ Automotive
- ⊙ Science research
- ⊙ Vacuum
- ⊙ Computer



- ⊙ Oil and gas
- ⊙ Nuclear
- ⊙ Renewable Energy
- ⊙ Battery
- ⊙ fuel cell
- ⊙ Energy

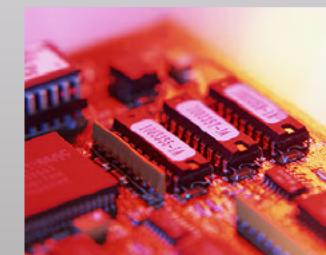

- ⊙ Target acquisition
- ⊙ Military charge
- ⊙ Power module
- ⊙ Acoustic measurement
- ⊙ Infrared thermal imaging
- ⊙ Electronic compass



PUSH-PULL SELF-LATCHING CONNECTION SYSTEM

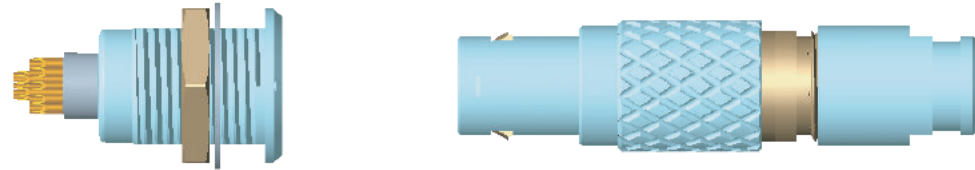

Mechanical locking performance

	Fv Average locking force	The self-latching system allows the connector to be mated by simply pushing the plug axially into the socket.
	Fd Average pulling force (Axial pull shell)	Once firmly latched, connection cannot be broken by pulling on the cable or any other component part other than the outer release sleeve.
	Fa Average pushing force (Axial pull cap)	When required, the connector is disengaged by a single axial pull on the outer release sleeve. This first disengages the latches and then withdraws the plug from the socket.

Standard series

Force (N)	Series			
	00	0S	1S	2S
Fv	9	14	15	17
Fd	7	9	10	11
Fa	120	140	250	350

Keyed series

Force (N)	Series				
	00	0B	1B	2B	3B
Fv	9	10	14	15	17
Fd	7	8	11	12	14
Fa	120	250	300	400	550

Watertight keyed series

Force (N)	Series			
	0K	1K	2K	3K
Fv	14	16	20	32
Fd	9	10	13	25
Fa	250	300	400	550

Note: 1N=0.102kg

Note: The forces mentioned tested with shell only which without contact.

Endurance: 5000 cycles

After rated cycling, locking system is still valid. (1 cycling = 1 push-pull, 300 cycles/h)

This value measured by IEC 60512-7 test 13a.

DEFINITION OF INGRESS PROTECTION (IP CODE)

IEC 60529 outlines an international classification system for the sealing effectiveness of enclosures of electrical equipment against the intrusion into the equipment of foreign bodies (i.e. tools, dust, fingers) and moisture. This classification system utilizes the letters «IP» (Ingress Protection) followed by two digits.

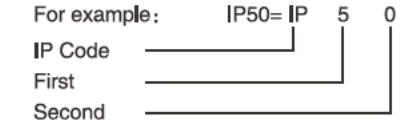

Degrees of protection - First digit

The first digit of the IP code indicates the degree to which persons are protected against contact with moving parts and the degree that equipment is protected against solid foreign bodies intruding into an enclosure.

Code	First digit description
0	No special protection
1	Protection from a large part of the body such as hand or from solid objects greater than 50 mm in diameter
2	Protection against objects not greater than 80 mm in length and 12 mm in diameter
3	Protection from entry by tools, wires, etc., with a diameter or thickness greater than 2.5 mm
4	Protection from entry by solid objects with a diameter or thickness greater than 1.0 mm
5	Protection from the amount of dust that would interfere with the operation of the equipment
6	Dust-tight
7	-
8	-

Degrees of protection - Second digit

The second digit indicates the degree of protection of the equipment inside the enclosure against the harmful entry of various forms of moisture (e.g. dripping, spraying, submersion, etc.)

Code	Second digit description
0	No special protection
1	Protection from vertically dripping water
2	Protection from dripping water when tilted up to 15°
3	Protection from sprayed water
4	Protection from splashed water
5	Protection from water projected from a nozzle
6	Protection against heavy seas, or powerful jets of water
7	Protection against temporary immersion
8	Protection against complete continuous submersion in water

Definition of connectors

	B	K	M	Y	D	F	S	C	U	T	J	P	
Plug													
Socket													
Series	Indoor			Outdoor				Indoor		Outdoor		Indoor	
Environment	Indoor			Outdoor				Indoor		Outdoor		Indoor	
Ingress Protection	IP50			IP66-68 Vacuumtight				IP50		IP66-68 TVacuumtight		IP50-66	
Temperature	-55 °C--+250 °C								-55 °C--+250 °C		-55 °C--+125 °C	-20 °C--+120 °C	
Latching	Push-Pull Self-Latching										Bayonet latching	Claw locking type	Push-Pull Self-Latching
Insulator type	2-30 Pin		2-16 Pin	2-26 Pin	2-13 Pin	2-19 Pin	1-6 Pin	2-16 Pin	2-13 Pin	2-7 Pin	2-4 Pin	2-26 Pin	
Contact type	Solder or PCB print												
Features	Multiple key options												

CONTENT

Circular Metal Series

B series (Indoor, keyed)	
Main features	9
Part Numbering system	10
Housing model	11
Elbow socket models	19
Watertight or vacuumtight models	20
Alignment key	22
K series(Outdoor, keyed)	
Main features	24
Part Numbering system	25
Housing model	26
Watertight or vacuumtight models	29
Alignment key	30
M series(Outdoor, keyed)	
Main features	32
Part Numbering system	33
Housing model	34
Alignment key	35
Y series(Outdoor, keyed)	
Main features	37
Part Numbering system	38
Housing model	39
Alignment key	41
D series(Outdoor, keyed)	
Main features	43
Part Numbering system	44
Housing model	45
Alignment key	46
Insert Configuration(B,K,M,Y and D series)	47
Cable collet (B,K,M,Y and D series)	52
PCB Drilling Pattern	53
S series(Indoor, stepped Insert)	
Main features	58
Part Numbering system	59
Housing model	60
Elbow socket models	62
Insert Configuration	63
Coaxial series(Indoor, blind insertion)	
Main features	65
Part Numbering system	66
Housing model	67
Elbow socket models	69
Insert Configuration	73
Traxial series(Indoor, blind insertion)	
Main features	75
Part Numbering system	76
Housing model	77
Insert Configuration	80
Cable collet (S and coaxial series)	80
F series(Outdoor, half-shell keyed)	
Main features	82
Part Numbering system	83
Housing model	84
Insert Configuration	90
Alignment key	92
Cable collet	92

C series(Outdoor, half-shell and keying keyed)	
Main features	94
Part Numbering system	95
Housing model	96
Insert Configuration	97
U series(Outdoor, keyed)	
Main features	100
Part Numbering system	101
Housing model	102
Alignment key	103
Insert Configuration	104
Cable collet (C and U series)	105
T series(Outdoor, YLH bayonet connector)	
Main features	107
Part Numbering system	108
Housing model	109
Alignment key	109
Insert Configuration	119
J series(outdoor, rectangle connector)	
Main features	112
Part Numbering system	113
Housing model	114
Insert Configuration	115

Circular Plastic Series

P series(Indoor, keyed)	
Part Numbering system	117
0P series	
Housing model	118
Alignment key, accessories	119
Insert Configuration	120
PCB Drilling Pattern	121
1P series	
Housing model	122
Alignment key, accessories	124
Insert Configuration	125
PCB Drilling Pattern	126
2P series	
Housing model	127
Alignment key, accessories	128
Insert Configuration	129
PCB Drilling Pattern	130
Metal NIBP connectors	
	132

Accssories

Bend relief	136
Caps	137
Assembly Instructions	139
Cable assemblies	143

B SERIES

(INDOOR KEYED)



www.atd-shop.com

MAIN FEATURES:

1. Security of the push –pull self-latching system
2. Multipole types 2 to 30 contacts
3. Solder or PCB contacts (straight or elbow)
4. High Packing density for space saving
5. Multiple key options to avoid cross mating of similar connectors
6. Keying system (G key standard) for connector alignment
7. 360° screening for full EMC shielding

PART SECTION SHOWING INTERNAL COMPONENTS

B series

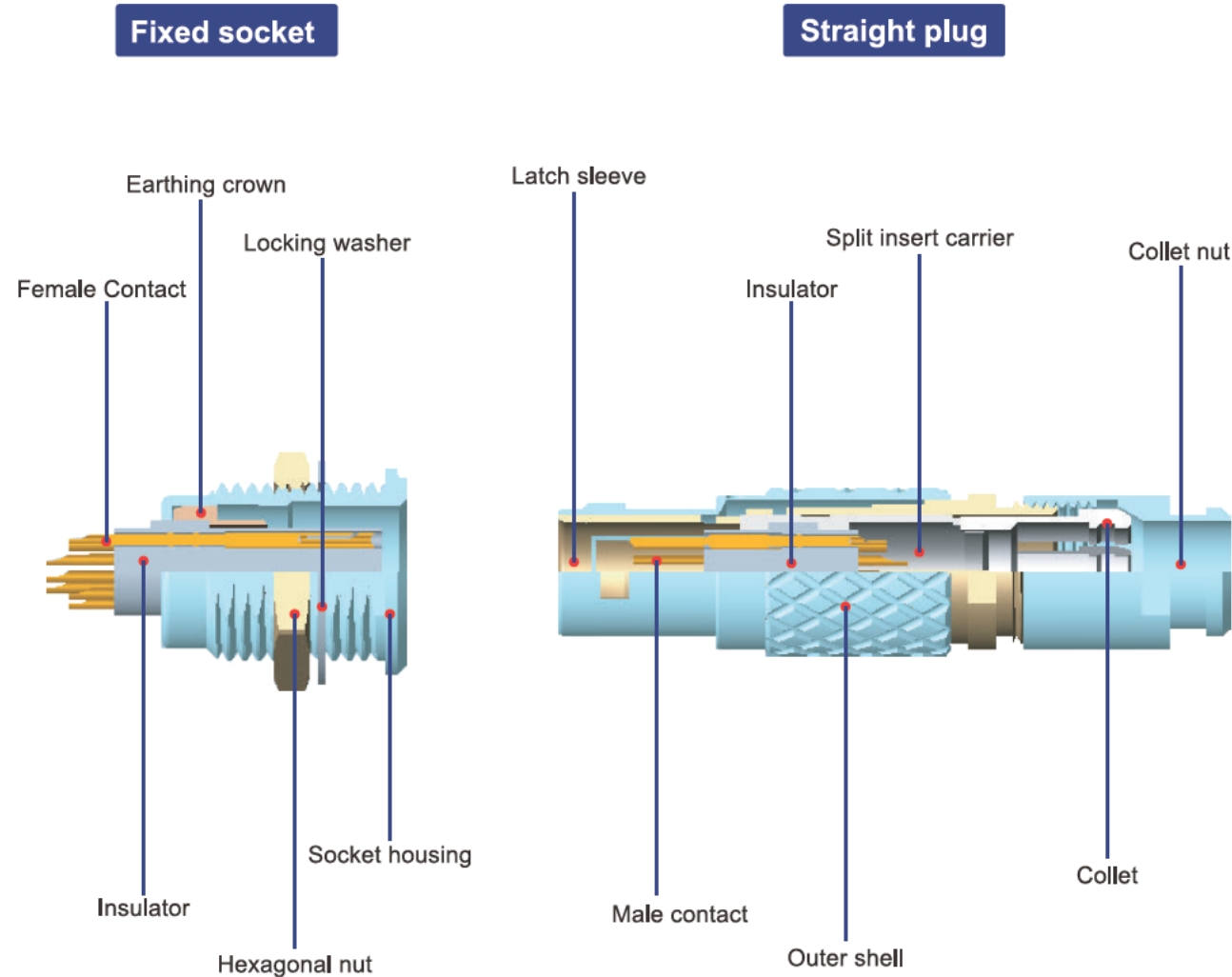

Part Numbering System

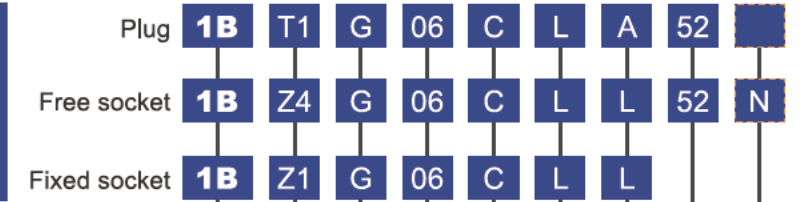

- 1.Series:(Page 11)
- 2.Housing model:(Page 11)
- 3.Alignment key:(Page 22)
- 4.Insert configuration:(Page 47)
- 5.Housing material
C=Chrome plated brass
K=Black Chrome plated brass
N=Nickel plated brass
T=Stainless steel
L=Aluminium alloy anodized
H=ABS/brass(only for Z11 and Z12 elbow sockets)
- 6.Insulator material
L=PPS、 T=PTFE
- 7.Contact type
A=Solder male L=Solder female
N=Print female V=Print female 90°
W=Print male 90° D=Print male
- 8.Cable OD:(Page 52)
- 9.Bend relief color, blank if without bend relief
N=Black ,G=Grey ,A=Blue
R=Red ,J=Yellow ,V=Green:(Page 136)

PART NUMBER EXAMPLE:

Straight plug with cable collet:
1BT1G06CLA52=1B series straight plug with key(G) and cable collet, multipole type with 6 contact s, outer shell in chrome plated brass, PPS insulator, solder male contacts, collet for 5.0mm diameter cable.

Free socket:
1BZ4G06CLL52N=1B series free socket with key(G) and cable collet, multipole type with 6 contacts, outer shell in chrome plated brass, PPS insulator, solder female contacts, collet for 5.0mm diameter cable and with a black bend relief.

Fixed socket:
1BZ1G06CLL=1B series fixed socket, nut fixing, with key(G) , multipole type with 6 contacts, outer shell in chrome plated brass, PPS insulator, solder female contacts.

TECHNICAL CHARACTERISTICS

Characteristics	Parameter
Locking Type	push pull self-latching type
Working Temperature	-55°~+250°
Maximum Humidity	up to 95% at 60°/140°F
Shielding Efficiency	75dB(10MHz) 40dB(1GHz)
Resistance to Vibration	15g[10Hz~2000Hz]

Characteristics	Parameter
Salt spray corrosion test	96hr
Shock resistance	100g,6ms
Endurance	5000 cycles
Protection index(mated)	IP50

Housing Models

T1 PLUG STRAIGHT PLUG, KEY (G) OR KEYS (A...M AND R), CABLE COLLET

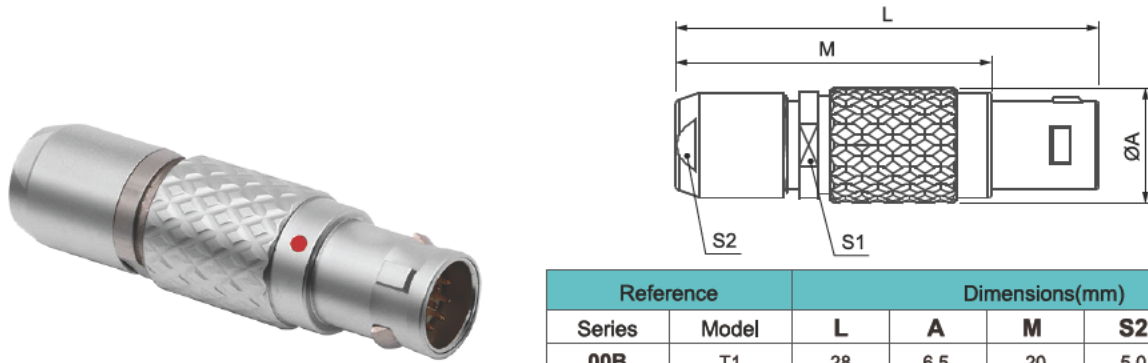

Reference		Dimensions(mm)				
Series	Model	L	A	M	S2	S1
00B	T1	28	6.5	20	5.0	5.5
0B	T1	35	9.5	26	7	8
1B	T1	43	12	32	9	10
2B	T1	50	15	38	12	13
3B	T1	57	18	42	15	15

T1 PLUG STRAIGHT PLUG, KEY (G) OR KEYS (A...M), CABLE COLLET AND NUT FOR FITTING A BEND RELIEF

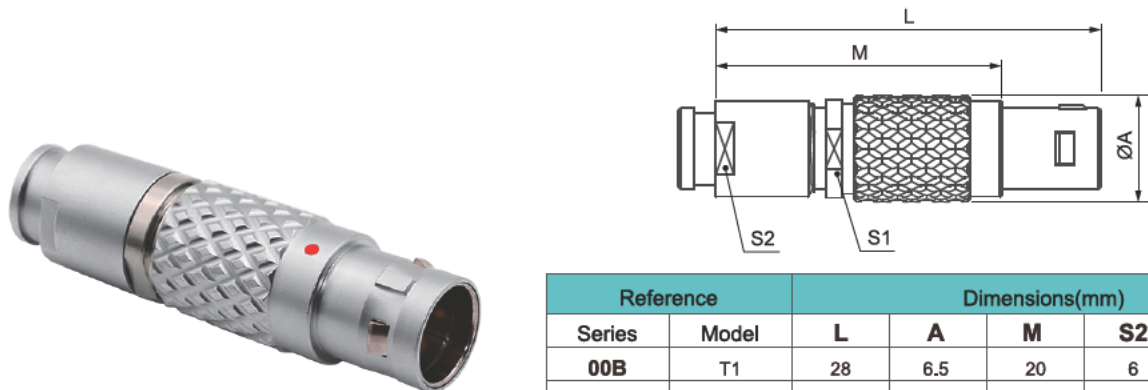

Reference		Dimensions(mm)				
Series	Model	L	A	M	S2	S1
00B	T1	28	6.5	20	6	5.5
0B	T1	35	9.5	25	8	8
1B	T1	41	12	30	9	10
2B	T1	48	15	36	13	13
3B	T1	57	18	42	15	15

T2 PLUG FIXED PLUG, NON-LATCHING, NUT FIXING, KEY (G) OR KEYS (A...L)

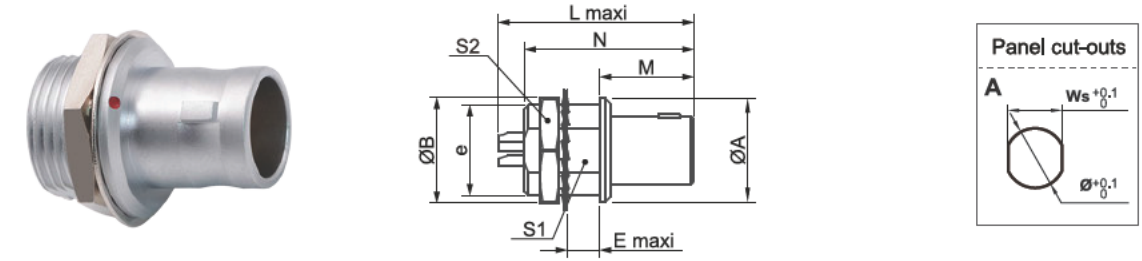

Reference		Dimensions(mm)									Panel cut-outs		
Series	Model	A	B	L	N	M	E	S1	S2	e	Ws	Ø	Type
00B	T2	8	10.2	18.1	15	9	2.9	6.3	9	M7*0.5	6.4	7.1	A
0B	T2	10	12.5	20.8	18.4	11.2	4.2	8.2	11	M9*0.5	8.3	9.1	A
1B	T2	14	16	25.2	22.6	12.5	5.4	10.5	14	M12*1.0	10.6	12.1	A
2B	T2	18	19.2	24.7	22.5	13.8	6.0	13.5	17	M15*1.0	13.6	15.1	A
3B	T2	21	25.4	32.1	29.1	17.0	5.8	16.5	22	M18*1.0	16.6	18.1	A

T3 PLUG ELBOW (90°) PLUG, KEY (G) OR KEYS (A...M AND R), CABLE COLLET

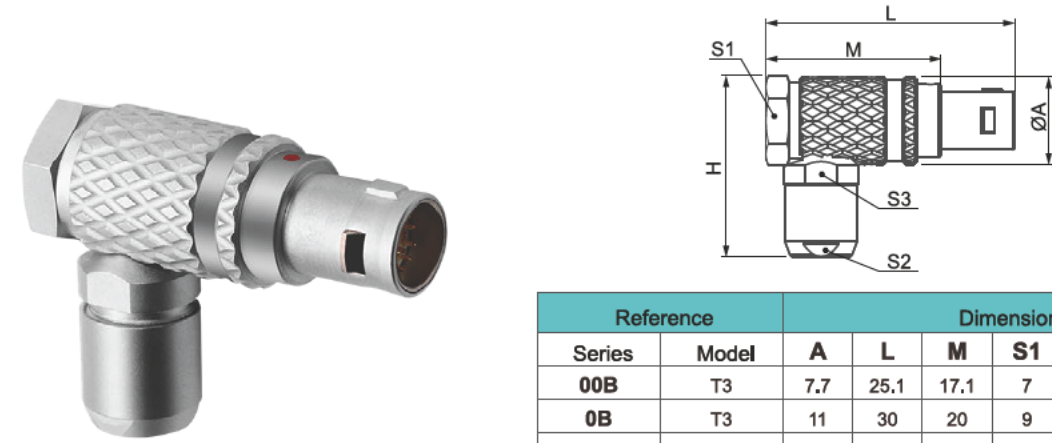

Reference		Dimensions(mm)						
Series	Model	A	L	M	S1	S2	S3	H
00B	T3	7.7	25.1	17.1	7	5	4	18.5
0B	T3	11	30	20	9	7	8	23
1B	T3	13.5	37	26	12	9	10	30.5
2B	T3	16.5	41.5	29.5	15	12	13	34
3B	T3	19	50	35	18	15	15	37

T4 PLUG STRAIGHT PLUG, KEY (G) OR KEYS (A...M AND R), CABLE COLLET AND LANYARD RELEASE

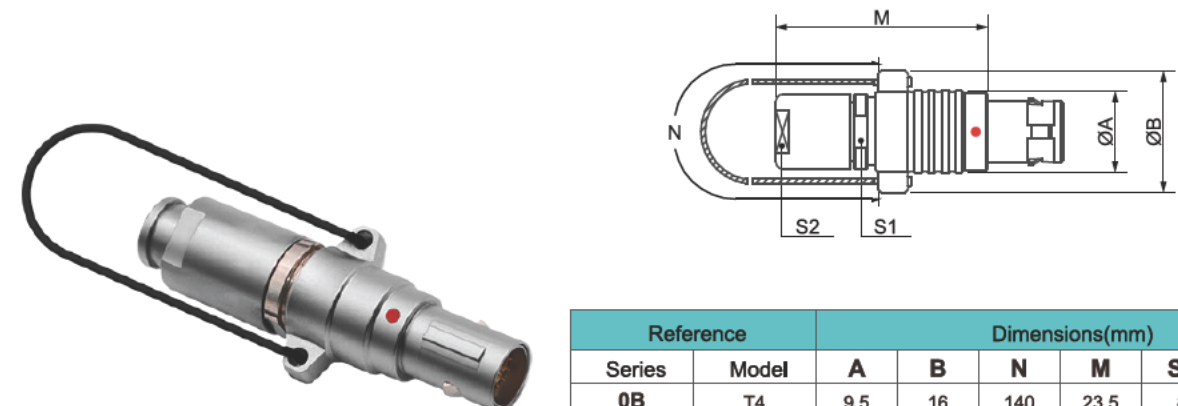

Reference		Dimensions(mm)					
Series	Model	A	B	N	M	S2	S1
0B	T4	9.5	16	140	23.5	8	8
1B	T4	12	18	140	34	9	10
2B	T4	14.6	21	160	42	13	13
3B	T4	18	25	190	42	15	15

T5 PLUG STRAIGHT PLUG, NON-LATCHING, KEY (G) OR KEYS (A...M), CABLE COLLET

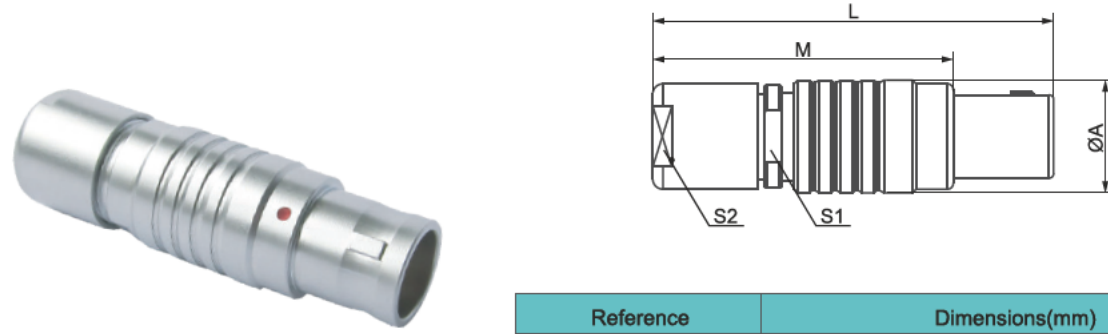

Reference		Dimensions(mm)				
Series	Model	L	A	M	S2	S1
0B	T5	35	9.5	25	8	7
1B	T5	41	12	30	9	10
2B	T5	48	15	36	13	13
3B	T5	57	18	42	15	15

T6 PLUG SEALED STRAIGHT PLUG, KEY(G) OR KEY (A...L), CABLE COLLET, FRONT SEAL AND NUT FOR FITTING A BEND RELIEF (PROTECTION DEGREE IP54 WHEN MATED)

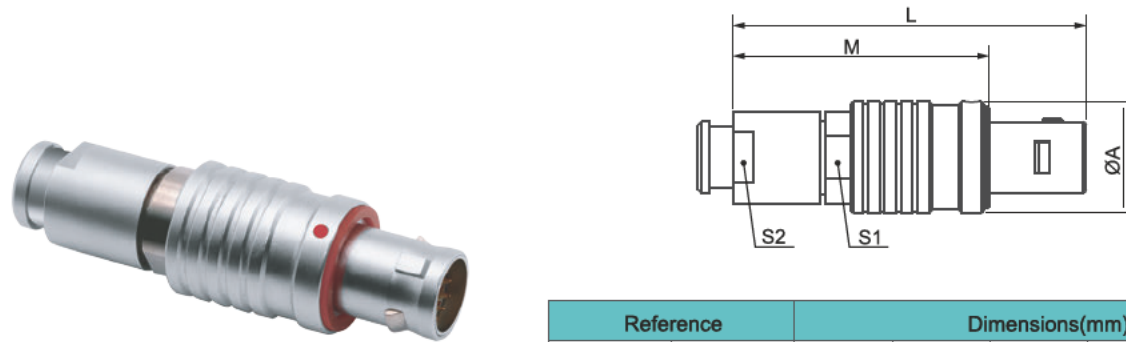

Reference		Dimensions(mm)				
Series	Model	A	L	M	S2	S1
0B	T6	11	35	23	8	8
1B	T6	13.5	42	33	9	10
2B	T6	16.5	48	36	13	13
3B	T6	19	56.5	41.5	15	15

T7 PLUG STRAIGHT PLUG, SHORT VERSION, KEY (G), CABLE COLLET



Reference		Dimensions(mm)				
Series	Model	A	M	L	S2	S1
0B	T7	9.5	24	34	7	8

T9 PLUG FIXED PLUG, NUT FIXING, KEY (G) OR KEYS (A...L)

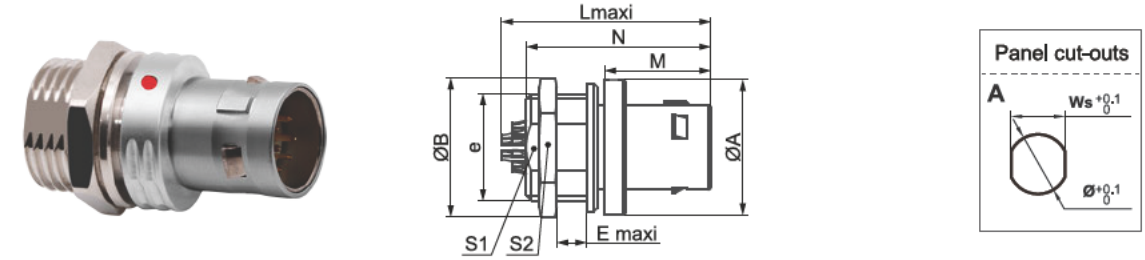

Reference		Dimensions(mm)									Panel cut-outs		
Series	Model	A	B	L	N	M	E	S1	S2	e	Ws	Ø	Type
0B	T9	10	12.5	20.8	18.4	11.2	4.2	8.2	11	M9*0.5	8.3	9.1	A
1B	T9	14	16	25.2	22.6	12.5	5.4	10.5	14	M12*1.0	10.6	12.1	A
2B	T9	18	19.2	24.7	22.5	13.8	6.0	13.5	17	M15*1.0	13.6	15.1	A

Z1 SOCKET FIXED SOCKET, FRONT PANEL MOUNT, NUT FIXING, KEY (G) OR KEYS (A...M AND R)

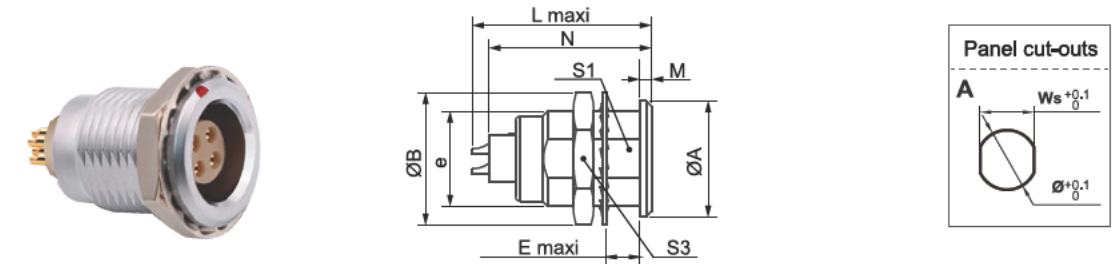

Reference		Dimensions(mm)									Panel cut-outs		
Series	Model	A	B	L	N	M	E	S1	S3	e	Ws	Ø	Type
00B	Z1	8	10.2	15.9	13.7	1.0	6.0	6.3	9	M7*0.5	6.4	7.1	A
0B	Z1	10	12.5	21.3	16.8	1.25	7.0	8.2	11	M9*0.5	8.3	9.1	A
1B	Z1	14	16	23.2	18.7	1.5	7.5	10.5	14	M12*1.0	10.6	12.1	A
2B	Z1	18	19.2	24.8	20	2	8.0	13.5	17	M15*1.0	13.6	15.1	A
3B	Z1	21	25.4	30.7	25	2	11	16.5	22	M18*1.0	16.6	18.1	A

Z2 SOCKET FIXED SOCKET WITH TWO NUTS, FRONT OR BACK PANEL MOUNT, KEY (G) OR KEYS (A...M AND R)

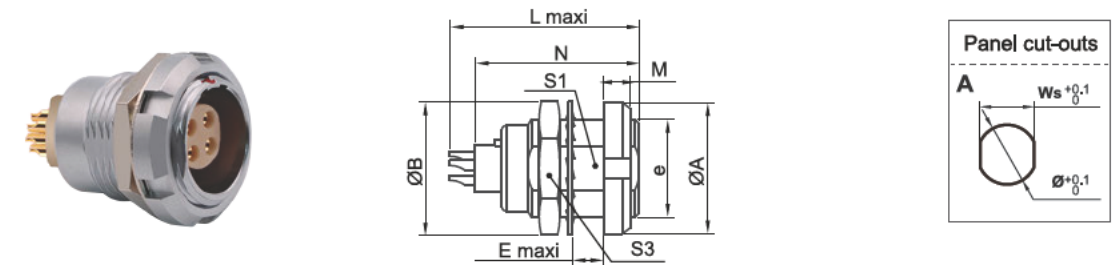

Reference		Dimensions(mm)									Panel cut-outs		
Series	Model	A	B	L	N	M	E	S1	S3	e	Ws	Ø	Type
00B	Z2	10	10.2	15.9	13.7	2.5	4.3	6.3	9	M7*0.5	6.4	7.1	A
0B	Z2	12	12.5	21.3	16.8	2.5	5.5	8.2	11	M9*0.5	8.3	9.1	A
1B	Z2	16	16.0	23.2	18.7	3.2	6.0	10.5	14	M12*1.0	10.6	12.1	A
2B	Z2	20	19.2	24.8	20	3.5	6.5	13.5	17	M15*1.0	13.6	15.1	A
3B	Z2	23	25.4	30.7	25	4.0	9.0	16.5	22	M18*1.0	16.6	18.1	A

Z2 SOCKET FIXED SOCKET WITH TWO NUTS, FRONT OR BACK PANEL MOUNT, KEY (G) OR KEYS (A...M AND R) AND STRAIGHT CONTACT FOR PCB

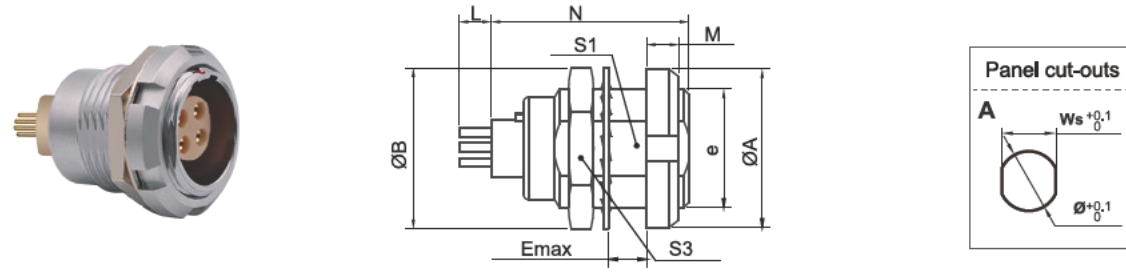

Reference		Dimensions(mm)									Panel cut-outs		
Series	Model	A	B	L	N	M	E	S1	S3	e	Ws	Ø	Type
0B	Z2	12	12.5	4	16.8	2.5	5.5	8.2	11	M9*0.5	8.3	9.1	A
1B	Z2	16	16.0	4	18.7	3.2	6.0	10.5	14	M12*1.0	10.6	12.1	A
2B	Z2	20	19.2	4	20	3.5	6.5	13.5	17	M15*1.0	13.6	15.1	A
3B	Z2	23	25.4	4.5	25	4.0	9.0	16.5	22	M18*1.0	16.6	18.1	A

Z2 SOCKET FIXED SOCKET WITH TWO NUTS, FRONT OR BACK PANEL MOUNT, KEY (G) OR KEYS (A...M AND R) ELBOW(90°) CONTACT FOR PCB

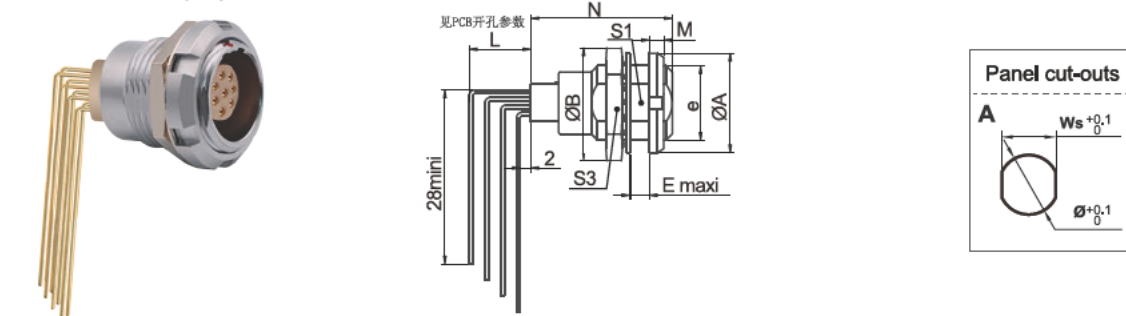

Reference		Dimensions(mm)									Panel cut-outs		
Series	Model	A	B	N	M	E	S1	S3	e	Ws	Ø	Type	
0B	Z2	12	12.5	16.8	2.5	5.5	8.2	11	M9*0.5	8.3	9.1	A	
1B	Z2	16	16.0	18.7	3.2	6.0	10.5	14	M12*1.0	10.6	12.1	A	
2B	Z2	20	19.2	20	3.5	6.5	13.5	17	M15*1.0	13.6	15.1	A	
3B	Z2	23	25.4	25	4.0	9.0	16.5	22	M18*1.0	16.6	18.1	A	

Z3 SOCKET FIXED SOCKET WITH TWO NUTS, BACK PANEL MOUNT, KEY (G) OR KEYS (A...M AND R)

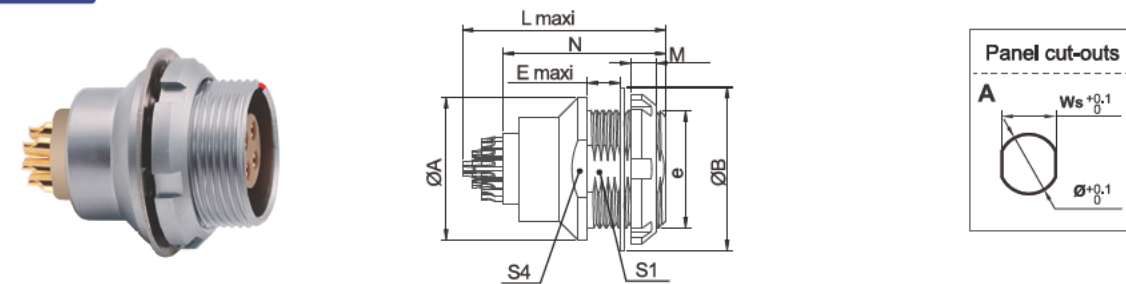

Reference		Dimensions(mm)									Panel cut-outs		
Series	Model	A	B	L	N	M	E	S1	S4	e	Ws	Ø	Type
00B	Z3	8.5	10	15.9	13.7	2.5	4.0	6.3	7.5	M7*0.5	6.4	7.1	A
0B	Z3	11	12	22	16.8	2.5	2.5	8.2	9	M9*0.6	8.3	9.1	A
1B	Z3	14	26	24	18.7	3.2	5.0	10.5	12	M12*1.0	10.6	12.1	A
2B	Z3	18	20	27.5	20	3.5	4.5	13.5	15	M15*1.0	13.6	15.1	A
3B	Z3	21.8	23	31	25	4.0	9.0	16.5	20	M18*1.0	16.6	18.1	A

Z4 SOCKET FREE SOCKET, FOR CABLE CONNECTING, CABLE MOUNT, KEY (G) OR KEYS (A...M AND R) AND NUT FOR FITTING A BEND RELIEF

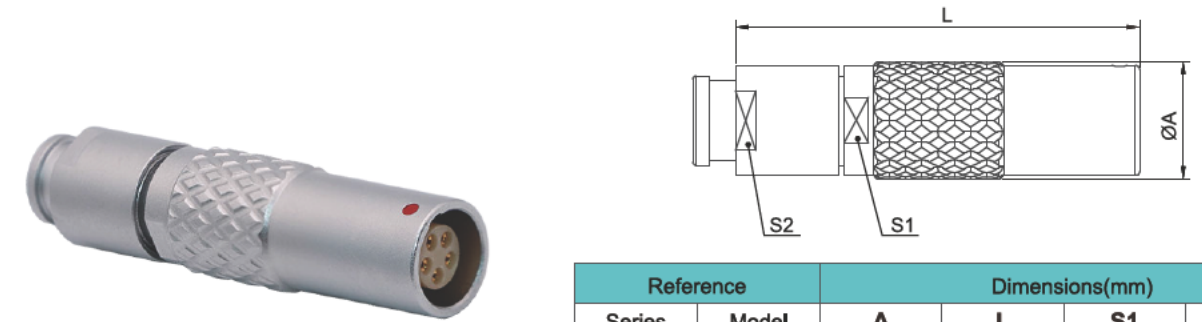

Reference		Dimensions(mm)			
Series	Model	A	L	S1	S2
00B	Z4	6.8	26.5	5.5	6
0B	Z4	9.6	34.5	8.0	8
1B	Z4	12.0	40.0	10.0	9
2B	Z4	16.5	48.0	13.0	13
3B	Z4	19.0	55.0	16.0	15

Z5 SOCKET FIXED SOCKET WITH EARTHING TAG, PANEL MOUNT, NUT FIXING, KEY (G) OR KEYS (A...M AND R)

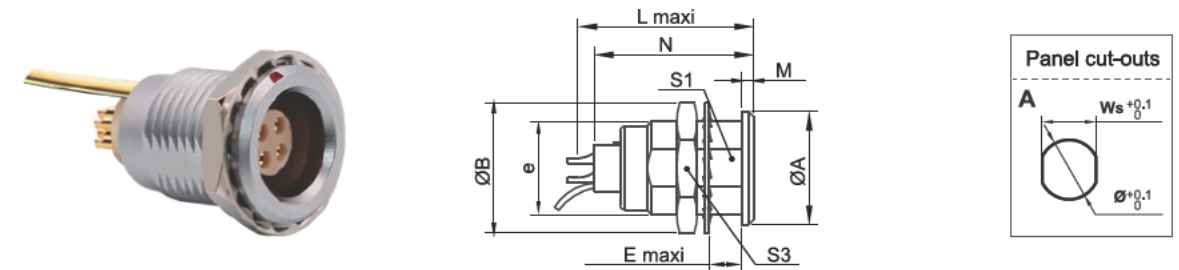

Reference		Dimensions(mm)									Panel cut-outs		
Series	Model	A	B	L	N	M	E	S1	S3	e	Ws	Ø	Type
00B	Z5	8	10.2	15.9	13.7	1.0	6	6.3	9	M7*0.5	6.4	7.1	A
0B	Z5	10	12.5	21.3	16.8	1.25	7	8.2	11	M9*0.5	8.3	9.1	A
1B	Z5	14	16	23.2	18.7	1.5	7.5	10.5	14	M12*1.0	10.6	12.1	A
2B	Z5	18	19.2	24.8	20	2	8	13.5	17	M15*1.0	13.6	15.1	A
3B	Z5	21	25.4	30.7	25	2	11	16.5	22	M18*1.0	16.6	18.1	A

Z6 SOCKET FIXED SOCKET, NUT FIXING, KEY (G) OR KEYS (A...M AND R), AND PROTRUDING SHELL

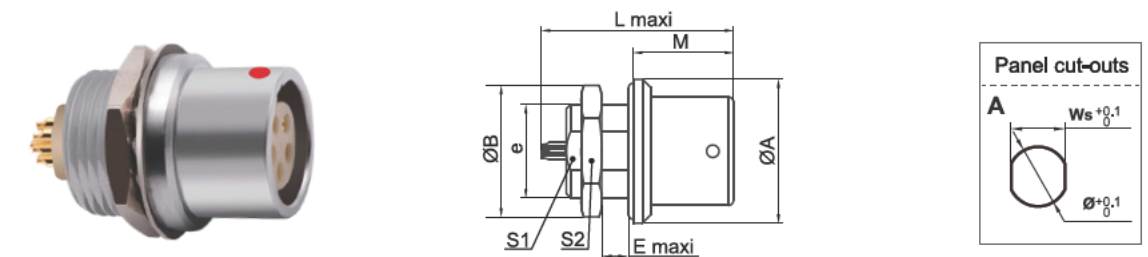

Reference		Dimensions(mm)									Panel cut-outs		
Series	Model	A	B	L	M	E	S1	S2	e	Ws	Ø	Type	
0B	Z6	10	12.5	20	9.8	3.5	8.2	11	M9*0.6	8.3	9.1	A	
1B	Z6	14	16.0	19.5	11	4	10.5	14	M12*1.0	10.6	12.1	A	
2B	Z6	18	19.2	24	12	5.1	13.5	17	M15*1.0	13.6	15.1	A	

Z9 SOCKET FIXED SOCKET, KEY (G) OR KEYS (A...M AND R), PANEL MOUNT WITH CABLE COLLET

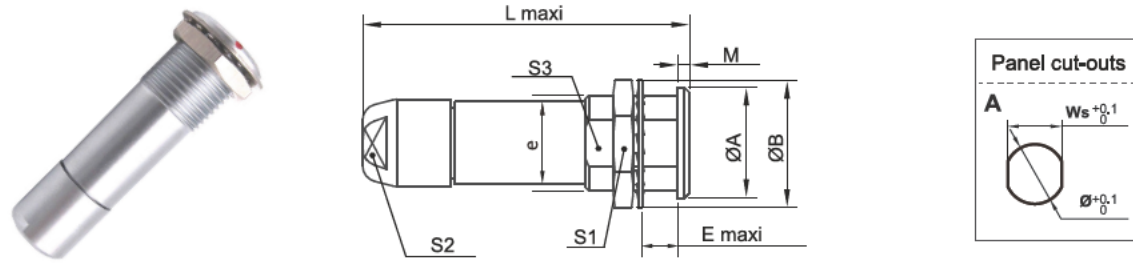

Reference		Dimensions(mm)									Panel cut-outs		
Series	Model	A	B	L	E	M	S1	S2	S3	e	Ws	Ø	Type
0B	Z9	10	12.3	35.5	7	1.2	11	8	8.2	M9*0.5	8.3	9.1	A
1B	Z9	14	16	40.5	7.5	1.5	14	9	10.5	M12*1.0	10.6	12.1	A
2B	Z9	18	19.2	47	8.5	2	17	13	13.5	M15*1.0	13.6	15.1	A
3B	Z9	21	25	56	11.5	2	22	15	16.5	M18*1.0	16.6	18.1	A

Z10 SOCKET FIXED SOCKET, WITH TWO NUTS, KEY (G) OR KEYS (A...M AND R), PANEL MOUNT WITH CABLE COLLET

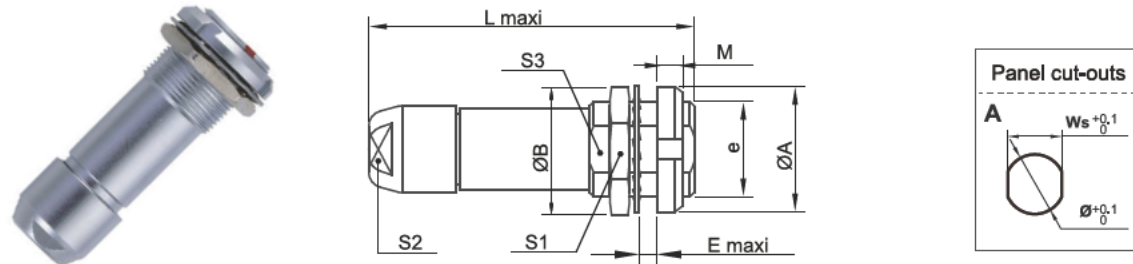

Reference		Dimensions(mm)									Panel cut-outs		
Series	Model	A	B	L	E	M	S1	S2	S3	e	Ws	Ø	Type
0B	Z10	12	12.3	35.5	5	2.5	11	8	8.2	M9*0.5	8.3	9.1	A
1B	Z10	16	16	40.5	5	3.2	14	9	10.5	M12*1.0	10.6	12.1	A
2B	Z10	20	19.2	47	6.5	3.5	17	13	13.5	M15*1.0	13.6	15.1	A
3B	Z10	24	25	56	9	4.5	22	15	16.5	M18*1.0	16.6	18.1	A

Z19 SOCKET FIXED COUPLER, NUT FIXING, KEY (G) AT BOTH ENDS

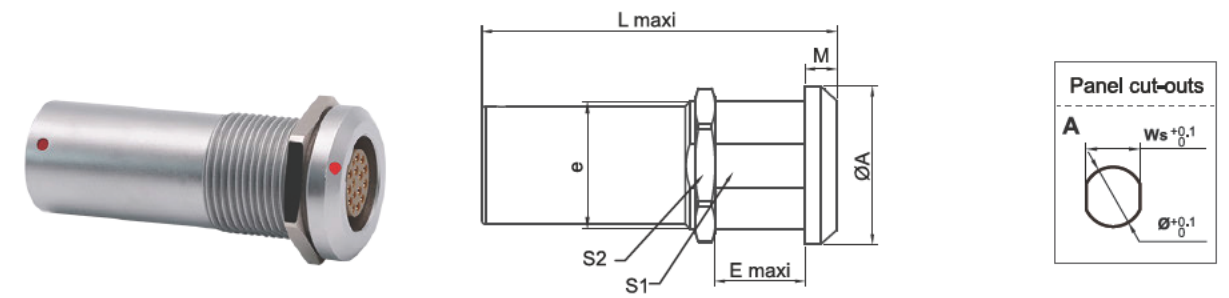

Reference		Contacts	Dimensions(mm)							Panel cut-outs		
Series	Model	type	A	L	M	E	S1	S2	e	Ws	Ø	Type
2B	Z19	female-female	19.8	44.5	4	12	15	16	M16*1.0	15.1	16.1	A

EXAMPLE:

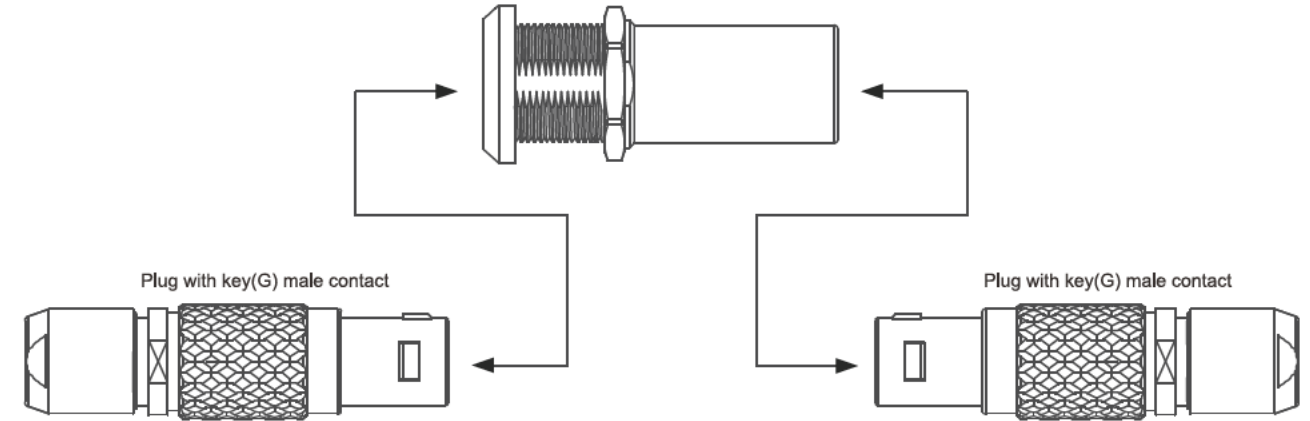

ELBOW SOCKET MODELS

Z11 SOCKET ELBOW (90°) SOCKET FOR PRINTED CIRCUIT, GROUND SOLDER FIXED, KEY (G) OR KEYS (A...M), DIMENSIONS FOR SOLDER SIDE AND CONTACT SIDE AS BELOW

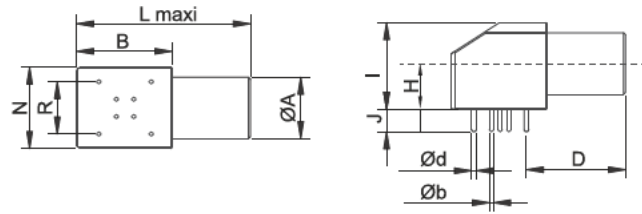
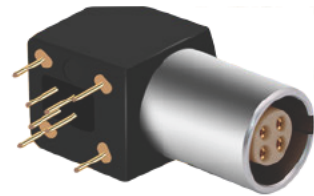

Reference		Dimensions(mm)										
Series	Model	L	B	N	I	H	A	D	d	R	J	b
00B	Z11	18,5	8,9	7,5	7,0	3,5	6,8	11,5	0,7	5,08	5	0,5
0B	Z11	25	13,3	11,7	12,7	6,7	9	14,6	0,7	7,62	3	0,6
1B	Z11	27	13,3	12,6	14	7,5	11	16,67	0,7	7,62	3	0,6

Z12 SOCKET ELBOW (90°) SOCKET FOR PRINTED CIRCUIT, WITH TWO NUTS, KEY (G) OR KEYS (A...M), DIMENSIONS FOR SOLDER SIDE AND CONTACT SIDE AS BELOW

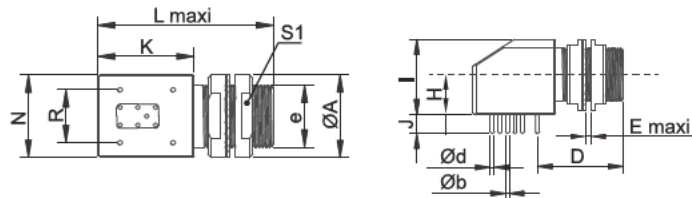
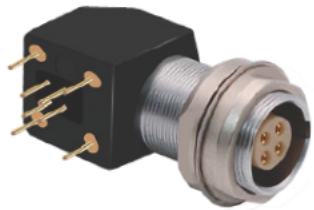

Reference		Dimensions(mm)													
Series	Model	L	K	A	N	R	S1	e	I	H	E	J	D	d	b
0B	Z12	25	13,3	12	11,7	7,62	10	M9*0,5	12,7	6,7	3,5	3	14,6	0,7	0,6
1B	Z12	27	13,3	14	12,6	7,62	13	M11*1,0	14	7,5	5,0	3	16,6	0,7	0,6

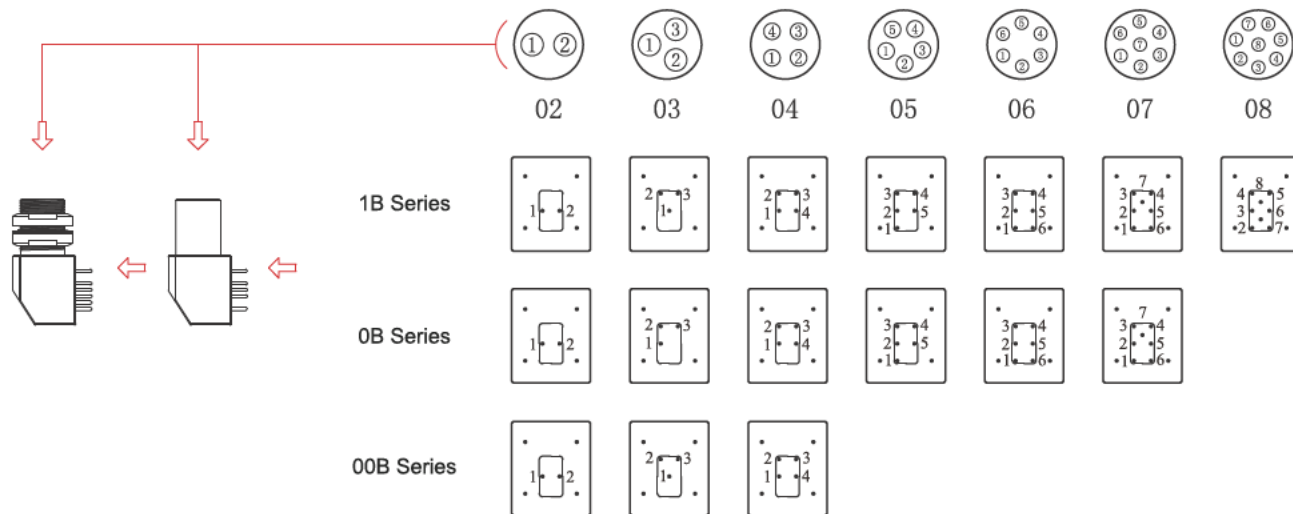

WATERTIGHT OR VACUUMTIGHT MODELS (watertight when mated)

TECHNICAL CHARACTERISTICS

Characteristics	Parameter
Locking Type	push pull self-latching type
Working Temperature	-55°~+250°
Maximum Humidity	up to 95% at 60°/140°F
Shielding Efficiency	75dB(10MHz) 40dB(1GHz)
Resistance to Vibration	15g[10Hz~2000Hz]

Characteristics	Parameter
Salt spray corrosion test	96hr
Shock resistance	100g,6ms
Endurance	5000 cycles
Protection index(mated)	IP68

Z7 SOCKET FIXED SOCKET, NUT FIXING, BACK PANEL MOUNT, KEY (G) OR KEYS (A...M AND R)

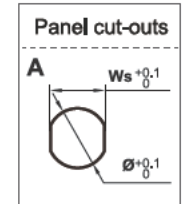
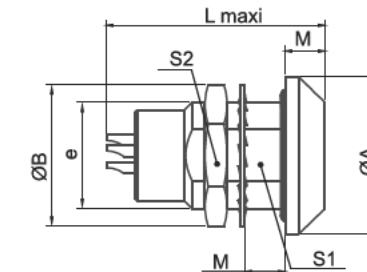

Reference		Dimensions(mm)									Panel cut-outs		
Series	Model	A	B	L	M	E	S1	S2	e	Ws	Ø	Type	
0B	Z7	13	12,5	20,2	3	5,5	8,2	11	M9*0,5	8,3	9,1	A	
1B	Z7	18	16,0	26,6	5,2	6	10,5	14	M12*1,0	10,6	12,1	A	
2B	Z7	20	19,2	24,8	4	8	13,5	17	M15*1,0	13,6	15,1	A	

Z8 SOCKET FIXED SOCKET, NUT FIXING, BACK PANEL MOUNT, KEY (G) OR KEYS (A...M AND R)

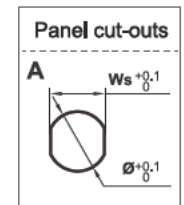
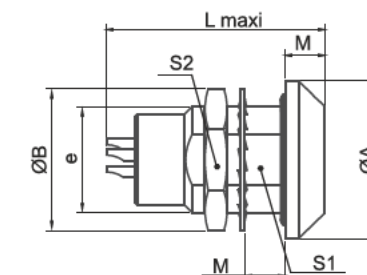

Reference		Dimensions(mm)										Panel cut-outs		
Series	Model	A	B	L	M	E	S1	S2	e	Ws	Ø	Type		
1B	Z8	18	16	30,3	5,2	6	10,5	14	M12*1,0	10,6	12,1	A		
2B	Z8	22	19,2	29,8	6	8	13,5	17	M15*1,0	13,6	15,1	A		
3B	Z8	27	25,4	34	6	12	19	22	M18*1,0	16,6	18,1	A		

Z13 SOCKET FIXED SOCKET, NUT FIXING, BACK PANEL MOUNT, KEY (G) OR KEYS (A...M AND R)

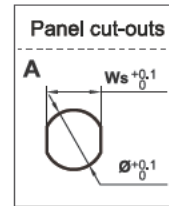
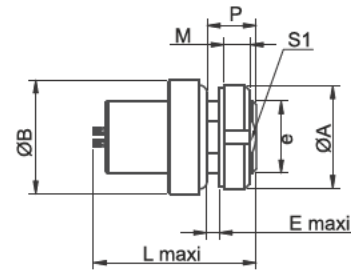

Reference		Dimensions(mm)								Panel cut-outs		
Series	Model	A	B	L	M	E	S1	e	Ws	Ø	Type	
00B	Z13	10	11	15.7	2.5	2.0	6.3	M7*0.5	6.4	7.1	A	
0B	Z13	12	13	21.7	2.5	5.5	8.2	M9*0.5	8.3	9.1	A	
2B	Z13	20	20	24.8	3.5	5.0	13.5	M15*1.0	10.6	12.1	A	

Z13 SOCKET FIXED SOCKET, NUT FIXING, BACK PANEL MOUNT, KEY (G) OR KEYS (A...M AND R)

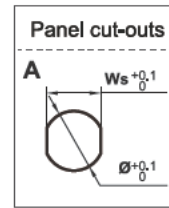
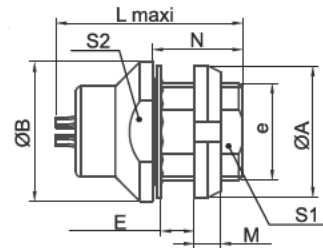

Reference		Dimensions(mm)									Panel cut-outs		
Series	Model	A	B	L	E	M	S1	S2	N	e	Ws	Ø	Type
1B	Z13	16	17	24.5	4.3	3.2	10.5	12	11	M12*1.0	10.6	12.1	A

B series Alignment Key and Polarized Keying System

Front view of a socket	Ref.	Nb of keys	Angles	Series			Ref.	Nb of keys	Angles	Series			Contact type		Note
				00	0B	1B				2B	3B	4B	Plug	Socket	
	G	1		0°	0°	0°	G	1		0°	0°	0°	male	female	●
	A	2	α	30°	30°	30°	A	2	α	30°	30°	30°	male	female	●
	B	2		60°	60°	60°	B	2		45°	45°	45°	male	female	●
	C	2		-	90°	90°	C	2		60°	60°	60°	male	female	○
	D	2	β	-	135°	135°	D	2	γ	95°	95°	95°	male	female	○
	E	2		-	145°	145°	E	2		120°	120°	120°	male	female	○
	F	2	-	155°	155°	F	2	β	145°	145°	145°	male	female	●	
	J	2	γ	45°	45°	45°	J	2	α	37.5°	37.5°	37.5°	female	male	○
	K	2		-	70°	70°	K	2		32.5°	32.5°	32.5°	female	male	○
	L	2		-	80°	80°	L	2		γ	70°	70°	70°	female	male
	M	2	δ	-	110°	-	M	2	-	-	-	-	female	male	●
	Y	3		-	-	-	Y	3	β	112.5°	126°	112.5°	male	female	●
				-	-	-				γ	100°	102°			

Front view of a socket	Ref.	Nb of keys	Angles	Series			Ref.	Nb of keys	Angles	Series			Contact type		Note
				00	0B	1B				2B	3B	4B	Plug	Socket	
	R	5	α	-	-	-	R	5	α	-	-	-	male	female	●
			β	-	-	-			β	-	-	-			
			-	-	-	-			-	-	-	-			
			-	-	-	-			-	-	-	-			

K SERIES

(OUTDOOR KEYED)

K series connectors are designed for out door applications. All models of this series are watertight when mated to give a protection degree IP68 when correctly assembled to an appropriate cable(otherwise IP66).



MAIN FEATURES:

1. Security of the push –pull self-latching system
2. Multipole types 2 to 26 contacts
3. Solder or PCB contacts (straight or elbow)
4. High Packing density for space saving
5. Multiple key options to avoid cross mating of similar connectors
6. Keying system (G key standard) for connector alignment
7. 360° screening for full EMC shielding
8. Rugged housing for extreme working conditions
9. IP Rating: IP66-68

PART SECTION SHOWING INTERNAL COMPONENTS

K series

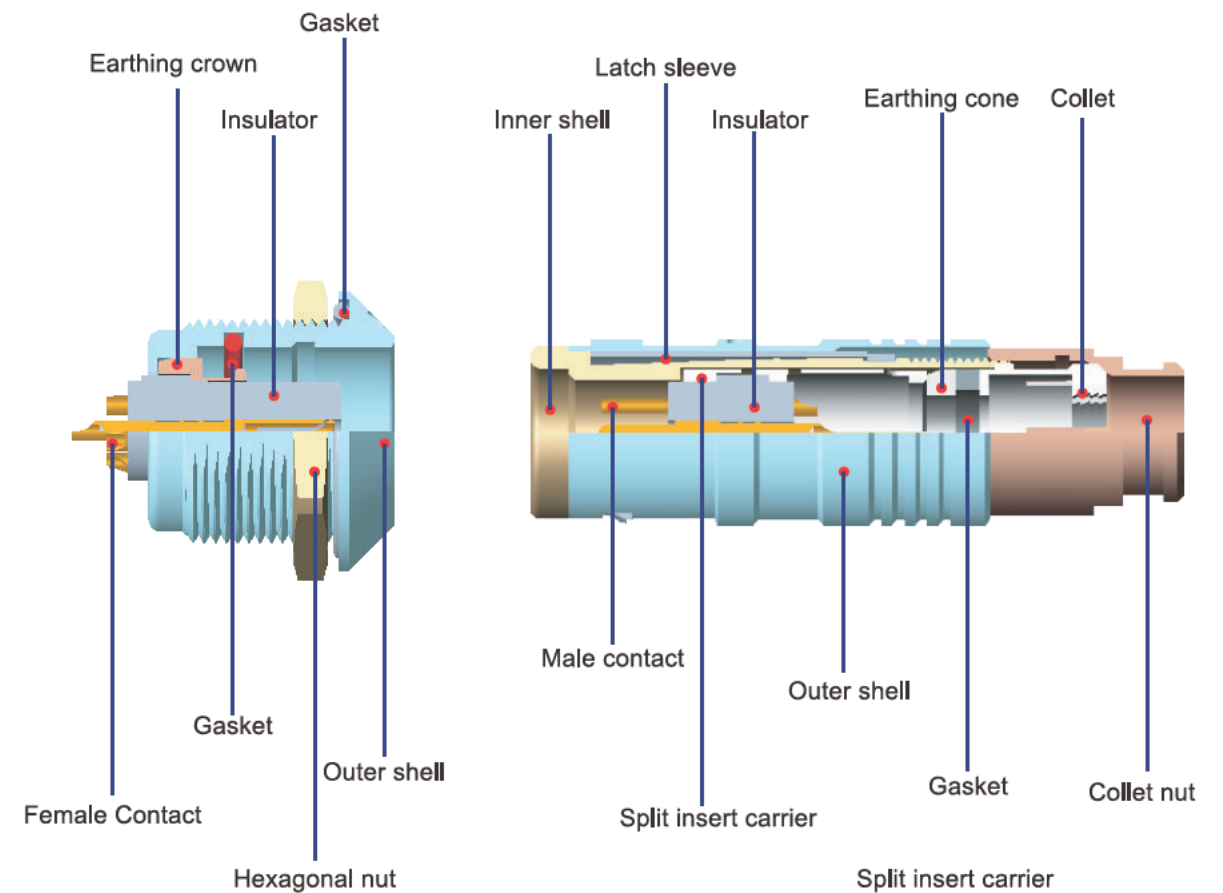

Part Numbering System

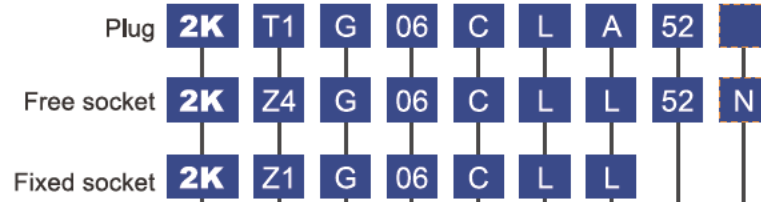

1. Series: (page 26)
2. Housing model: (page 26)
3. Alignment key: (page 30)
4. Insert configuration: (Page 47)
5. Housing material
C=Chrome plated brass
K=Black Chrome plated brass
N=Nickel plated brass
T=Stainless steel
L=Aluminium alloy anodized
6. Insulator material
L=PPS, T=PTFE
7. Contact type
A=Solder male L=Solder female
N=Print female V=Print female 90°
W=Print male 90° D=Print male
8. Cable OD: (Page 52)
9. Bend relief color, blank if without bend relief
N=Black, G=Grey, A=Blue
R=Red, J=Yellow, V=Green: (Page 136)

TECHNICAL CHARACTERISTICS

Characteristics	Parameter
Locking Type	push pull self-latching type
Working Temperature	-55°~+250°
Maximum Humidity	up to 95% at 60°/140°F
Shielding Efficiency	75dB(10MHz) 40dB(1GHz)
Resistance to Vibration	15g[10Hz~2000Hz]

Characteristics	Parameter
Salt spray corrosion test	96hr
Shock resistance	100g,6ms
Endurance	5000 cycles
Protection index(mated)	IP66-68

Housing Models

T1 PLUG STRAIGHT PLUG, WATERTIGHT, KEY (G) OR KEYS (A...M AND R), CABLE COLLET

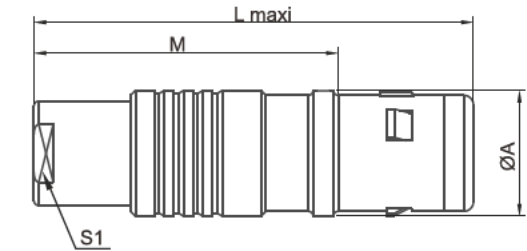

Reference		Dimensions(mm)			
Series	Model	A	L	M	S1
0K	T1	11	37.5	26.5	8
1K	T1	13	43	29	9
2K	T1	16	50	34	13
3K	T1	19	60	40	15

T1 PLUG STRAIGHT PLUG, WATERTIGHT, KEY (G) OR KEYS (A...M), CABLE COLLET AND NUT FOR FITTING A BEND RELIEF

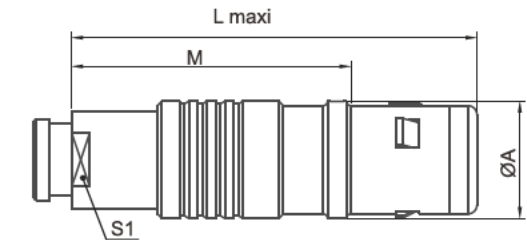

Reference		Dimensions(mm)			
Series	Model	A	L	M	S1
0K	T1	11	36.5	25	8
1K	T1	13	45	30	9
2K	T1	16	50	33.8	13
3K	T1	19	60	40	15

PART NUMBER EXAMPLE:

Straight plug with cable collet:

2KT1G06CLA52=series straight plug with key(G) and cable collet, multipole type with 6 contact s, outer shell in chrome plated brass, PPS insulator, solder male contacts, collet for 5.0mm diameter cable.

Free socket:

2KZ4G06CLL52N=2K series free socket with key(G) and cable collet, multipole type with 6 contacts, outer shell in chrome plated brass, PPS insulator, solder female contacts, collet for 5.0mm diameter cable and with a black bend relief.

Fixed socket:

2KZ1G06CLL=12K series fixed socket, nut fixing, with key(G), multipole type with 6 contacts, outer shell in chrome plated brass, PPS insulator, solder female contacts.

T3 PLUG ELBOW (90°) PLUG, WATERTIGHT, KEY (G) OR KEYS(A...F, LAND R), CABLE COLLET

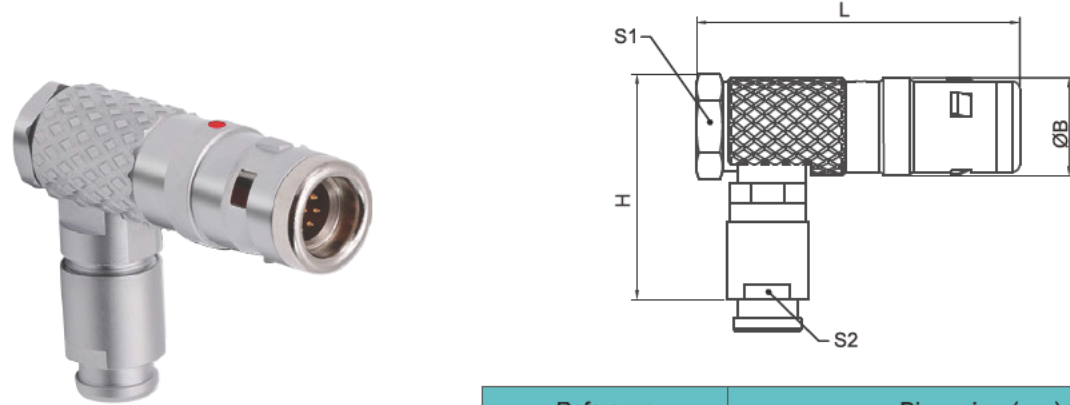

Reference		Dimensions(mm)				
Series	Model	A	L	H	S1	S2
0K	T3	10,8	38	23,9	8	9
1K	T3	13	43	30	9	12

Z1 SOCKET FIXED SOCKET, FRONT PANEL MOUNT, NUT FIXING, KEY (G) OR KEYS (A...F, LAND R)

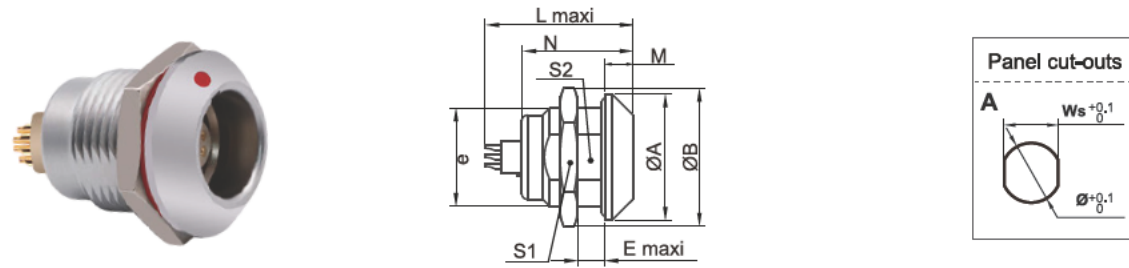

Reference		Dimensions(mm)									Panel cut-outs		
Series	Model	A	B	L	N	M	E	S1	S2	e	Ws	Ø	Type
0K	Z1	18	19,2	22,5	16	4	4,5	17	12,5	M14*1,0	12,6	14,1	A
1K	Z1	20	22	30	21,5	4,5	9,5	19	14,5	M16*1,0	14,6	16,1	A
2K	Z1	35	27,7	29	22	5	9,5	24	18,5	M20*1,0	18,6	20,1	A
3K	Z1	31	34	36,2	33,6	6	11	30	22,5	M24*1,0	22,6	24,1	A

Z3 SOCKET FIXED SOCKET, BACK PANEL MOUNT, KEY (G) OR KEYS (A...F, LAND R)

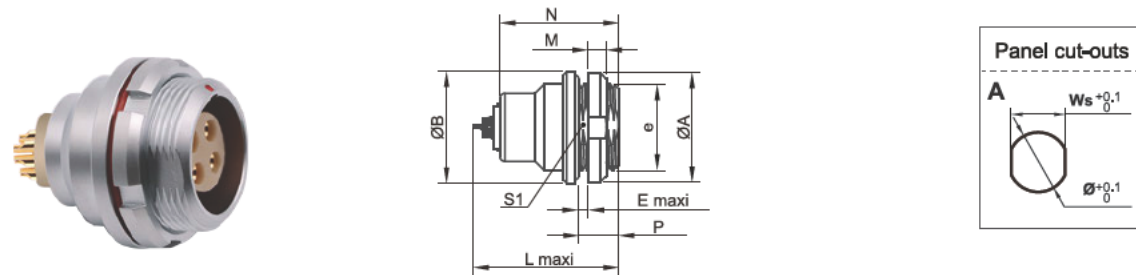

Reference		Dimensions(mm)									Panel cut-outs		
Series	Model	A	B	E	M	P	N	L	S1	e	Ws	Ø	Type
0K	Z3	18	18	2,5	3,5	7	16,0	22,5	12,5	M14*1,0	12,6	14,1	A
1K	Z3	20	20	5,5	3,0	10	21,5	30,0	14,5	M16*1,0	14,6	16,1	A
2K	Z3	25	25	5,0	3,5	10	22,0	29,0	18,5	M20*1,0	18,6	20,1	A
3K	Z3	30	30	7,0	4,5	12	29,1	37,5	22,5	M24*1,0	22,6	24,1	A

Z3 SOCKET FIXED SOCKET, BACK PANEL MOUNT, KEY (G) OR KEYS (A...F, LAND R) WITH STRAIGHT CONTACTS FOR PCB

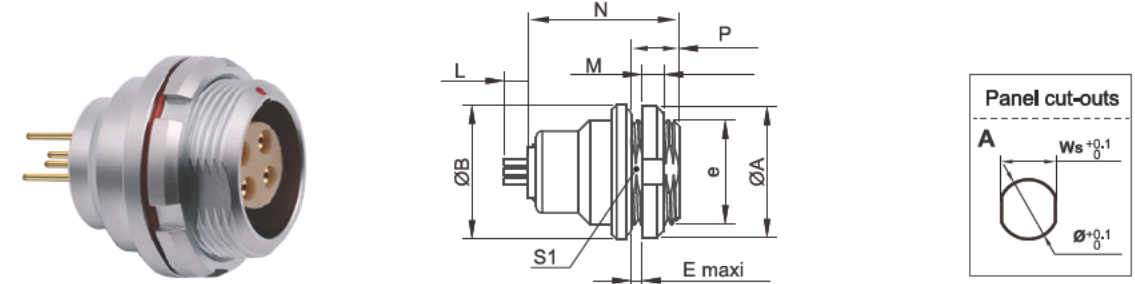

Reference		Dimensions(mm)									Panel cut-outs		
Series	Model	A	B	E	M	P	N	L	S1	e	Ws	Ø	Type
0K	Z3	18	18	2,5	3,5	7	16	22,5	12,5	M14*1,0	12,6	14,1	A
1K	Z3	18	18	5,5	3,0	10	21,5	30	14,5	M16*1,0	14,6	16,1	A
2K	Z3	25	25	5,0	3,5	10	22,5	29	18,5	M20*1,0	18,6	20,1	A
3K	Z3	30	30	7,0	4,5	12	29,1	37,5	22,5	M24*1,0	22,6	24,1	A

Z3 SOCKET FIXED SOCKET, BACK PANEL MOUNT, KEY (G) OR KEYS (A...F, LAND R) WITH ELBOW (90°) CONTACTS FOR PCB

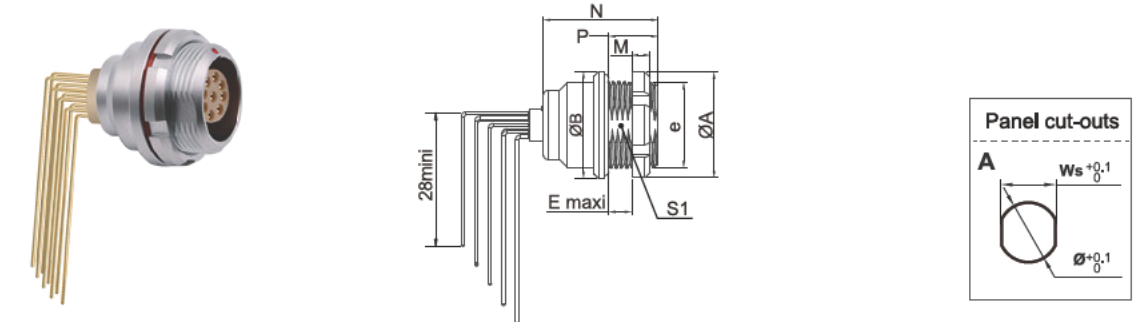

Reference		Dimensions(mm)									Panel cut-outs		
Series	Model	A	B	E	M	P	N	L	S1	e	Ws	Ø	Type
0K	Z3	18	18	2,5	3,5	7	16	22,5	12,5	M14*1,0	12,6	14,1	A
1K	Z3	18	18	5,5	3,0	10	21,5	30	14,5	M16*1,0	14,6	16,1	A
2K	Z3	25	25	5,0	3,5	10	22,5	29	18,5	M20*1,0	18,6	20,1	A
3K	Z3	30	30	7,0	4,5	12	29,1	37,5	22,5	M24*1,0	22,6	24,1	A

Z4 SOCKET FREE SOCKET, CABLE MOUNT, KEY (G) OR KEYS (A...M AND R) AND AND NUT FOR FITTING A BEND RELIEF



Reference		Dimensions(mm)		
Series	Model	A	L	S2
0K	Z4	13	34	8
1K	Z4	15	45	9
2K	Z4	19	53	13
3K	Z4	23	65	15

WATERTIGHT OR VACUUMTIGHT MODELS (watertight when mated)

Z7 SOCKET FIXED SOCKET, FRONT PANEL MOUNT, NUT FIXING, KEY (G) OR KEYS (A...F, LAND R)

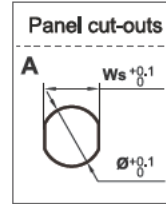
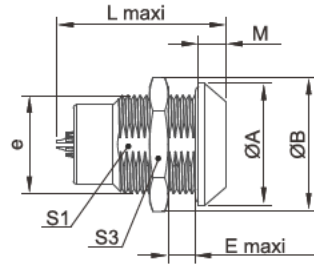

Reference		Dimensions(mm)								Panel cut-outs		
Series	Model	A	B	E	L	M	S1	S3	e	Ws	Ø	Type
0K	Z7	18	19.2	4.5	22.5	4.0	12.5	17	M14*1.5	12.6	14.1	A
1K	Z7	20	22	9.0	30.0	4.5	14.5	19	M16*1.0	14.6	16.1	A
2K	Z7	25	27.7	9.5	29.0	5.0	18.5	24	M20*1.0	18.6	20.1	A
3K	Z7	31	34	11	36.3	6.0	22.5	30	M24*1.0	22.6	24.1	A

Z13 SOCKET FIXED SOCKET, BACK PANEL MOUNT, KEY (G) OR KEYS (A...F, LAND R)

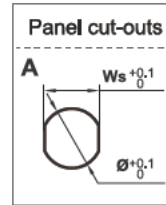
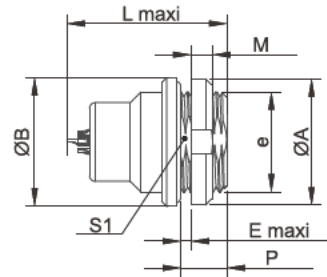

Reference		Dimensions(mm)								Panel cut-outs		
Series	Model	A	B	E	L	M	P	S1	e	Ws	Ø	Type
0K	Z13	18	18	2.0	22.5	3.5	7	12.5	M14*1.5	12.6	14.1	A
1K	Z13	20	20	5.5	30.0	3.0	10	14.5	M16*1.0	14.6	16.1	A
2K	Z13	25	25	5.0	29.0	3.5	10	18.5	M20*1.0	18.6	20.1	A

K series Alignment Key and Polarized Keying System

Front view of a socket	Ref.	Nb of keys	Angles	Series					Contact type		Note
				0K	1K	2K	3K	4K	Plug	Socket	
	G	1		0°	0°	0°	0°	0°	male	female	●
	A	2	α	30°	30°	30°	30°	30°	male	female	●
	B	2		45°	45°	45°	45°	45°	male	female	●
	C	2		60°	60°	60°	60°	60°	male	female	●
	D	2		95°	95°	95°	95°	95°	male	female	○
	E	2	β	120°	120°	120°	120°	120°	male	female	○
	F	2		145°	145°	145°	145°	145°	male	female	○
	L	2	γ	75°	75°	75°	75°	75°	female	male	●

Front view of a socket	Ref.	Nb of keys	Angles	Series					Contact type		Note
				0K	1K	2K	3K	4K	Plug	Socket	
	R	5	α	-	-	-	95°	-	male	female	●
			β	-	-	-	115°	-			
				-	-	-	35°	-			
				-	-	-	25°	-			

M SERIES

(OUTDOOR KEYED)



www.atd-shop.com

MAIN FEATURES:

1. Security of the push –pull self-latching system
2. Multipole types 2 to 16 contacts
3. Solder or PCB contacts (straight or elbow)
4. High Packing density for space saving
5. Keying system (G key standard) for connector alignment
6. 360° screening for full EMC shielding
7. Rugged housing for extreme working conditions
8. IP Rating: IP65

PART SECTION SHOWING INTERNAL COMPONENTS

M series

Fixed socket

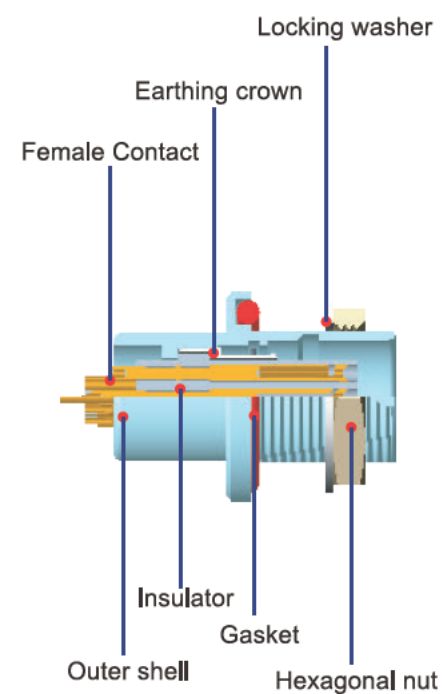

Straight plug

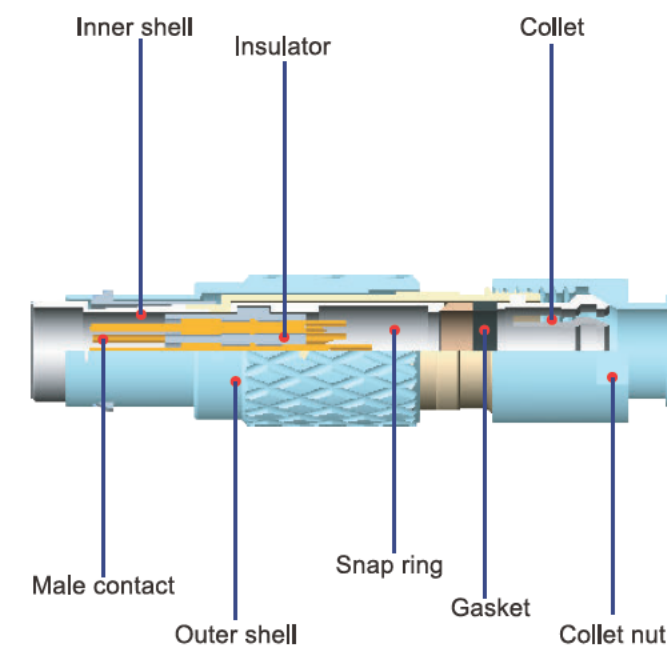

Part Numbering System

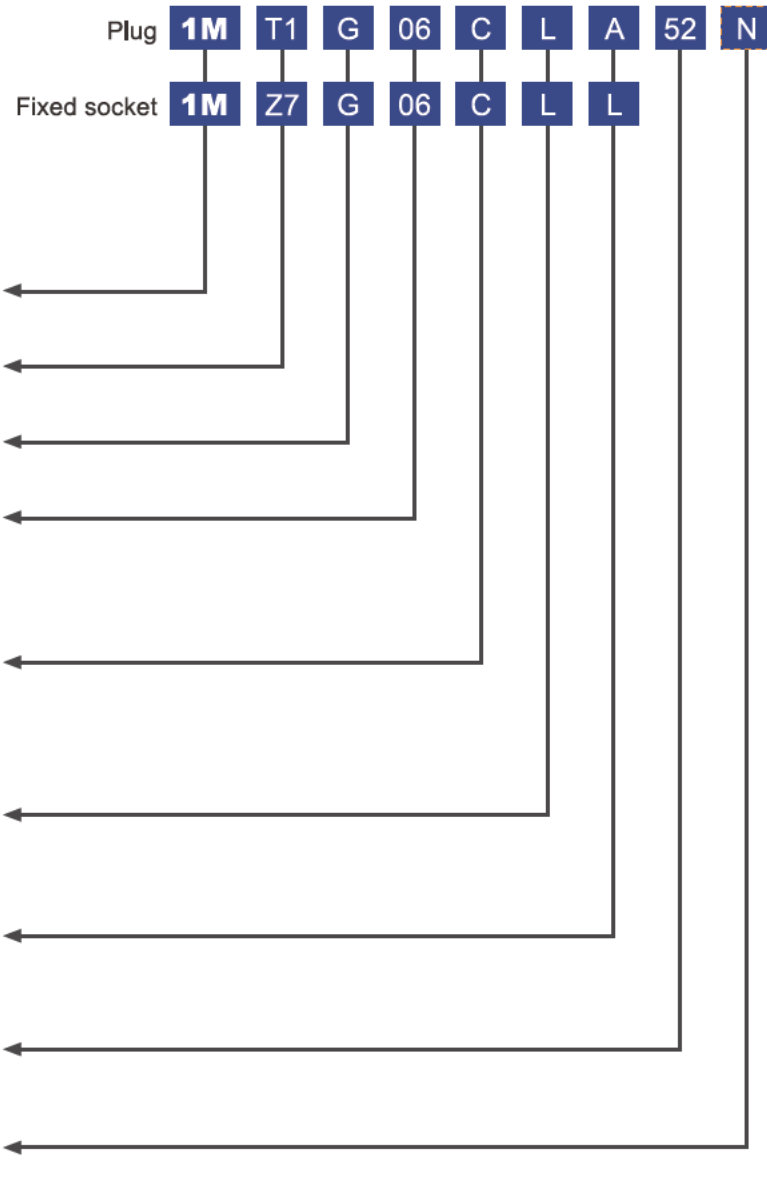

1. Series: (Page 34)
2. Housing model: (Page 34)
3. Alignment key: (Page 35)
4. Insert configuration: (Page 47)
5. Housing material
C=Chrome plated brass
K=Black Chrome plated brass
N=Nickel plated brass
T=Stainless steel
L=Aluminium alloy anodized
6. Insulator material
L=PPS, T=PTFE
7. Contact type
A=Solder male L=Solder female
N=Print female V=Print female 90°
W=Print male 90° D=Print male
8. Cable OD: (Page 52)
9. Bend relief color, blank if without bend relief
N=Black, G=Grey, A=Blue
R=Red, J=Yellow, V=Green: (Page 136)

TECHNICAL CHARACTERISTICS

Characteristics	Parameter
Locking Type	push pull self-latching type
Working Temperature	-55°~+250°
Maximum Humidity	up to 95% at 60°/140°F
Shielding Efficiency	75dB(10MHz) 40dB(1GHz)
Resistance to Vibration	15g[10Hz~2000Hz]

Characteristics	Parameter
Salt spray corrosion test	96hr
Shock resistance	100g,6ms
Endurance	5000 cycles
Protection index(mated)	IP65

Housing Models

T1 PLUG STRAIGHT PLUG, WATERTIGHT, KEY (G) OR KEYS (A...F, L AND R), CABLE COLLET AND NUT FOR FITTING A BEND RELIEF

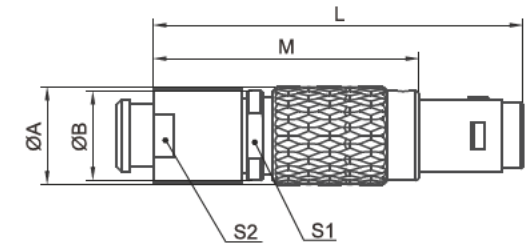

Reference		Dimensions(mm)					
Series	Model	L	M	A	B	M	S2
0M	T1	35.5	25.5	9.4	8.6	7.4	8.0
1M	T1	42.3	30.1	11.8	12.0	11.0	9.0

Z7 SOCKET FIXED SOCKET, FRONT PANEL MOUNT, NUT FIXING, KEY (G) OR KEYS (A...M AND R), WATERTIGHT OR VACUUM-TIGHT

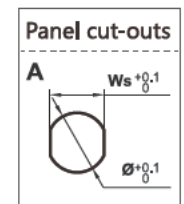
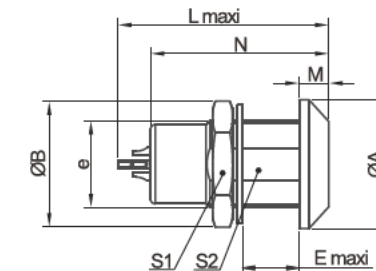

Reference		Dimensions(mm)									Panel cut-outs		
Series	Model	L	M	A	B	N	S1	S2	E	e	Ws	Ø	Type
0M	Z7	21	3	13	12.7	18	11	8.2	5.5	M9*0.5	8.3	9.1	A
1M	Z7	25	2	15	16	20.3	14	10.5	7.5	M12*1.0	10.6	12.1	A

PART NUMBER EXAMPLE:

Straight plug with cable collet:

1MT1G04CLA52N = 1M series straight plug with key(G) and cable collet, multipole type with 4 contacts, outer shell in chrome plated brass, PPS insulator, solder male contacts, collet for 5.2mm diameter cable, and with black bend relief

Fixed socket:

1MZ7G04CLL = 1M series fixed socket, nut fixing, with key(G), multipole type with 4 contacts, outer shell in chrome plated brass, PPS insulator, solder female contacts.

Z13 SOCKET FIXED SOCKET, BACK PANEL MOUNT, KEY (G) OR KEYS (A...M AND R), WATERTIGHT OR VACUUM-TIGHT

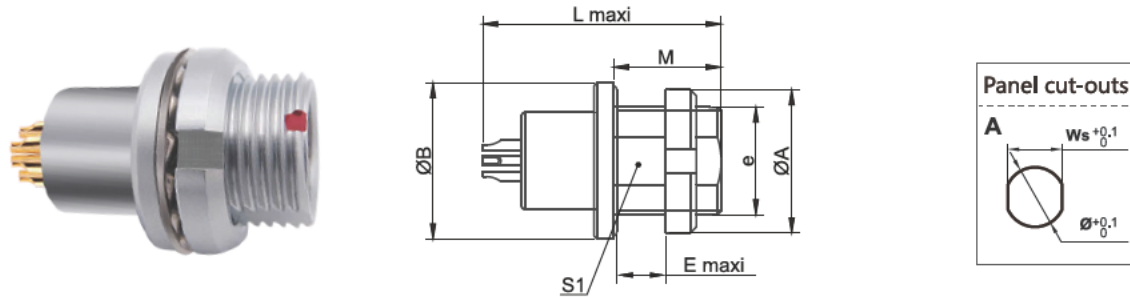

Reference		Dimensions(mm)							Panel cut-outs		
Series	Model	L	M	A	B	S1	E	e	Ws	Ø	Type
0M	Z13	21	8.9	11.9	12.9	8.2	4.5	M9*0.5	8.3	9.1	A
1M	Z13	25	10	16.0	15.5	10.5	5.5	M12*1.0	10.6	12.1	A

M series Alignment Key and Polarized Keying System

Front view of a socket	Ref.	Nb of keys	Angles	Series			Ref.	Nb of keys	Angles	Series			Contact type		Note
				00	0M	1M				2M	3M	4M	Plug	Socket	
	G	1		0°	0°	0°	G	1		0°	0°	0°	male	female	●
	A	2	α	30°	30°	30°	A	2	α	30°	30°	30°	male	female	●
	B	2		60°	60°	60°	B	2		45°	45°	45°	male	female	●
	C	2		-	90°	90°	C	2		60°	60°	60°	male	female	○
	D	2	β	-	135°	135°	D	2	γ	95°	95°	95°	male	female	○
	E	2		-	145°	145°	E	2		120°	120°	120°	male	female	○
	F	2		-	155°	155°	F	2		145°	145°	145°	male	female	●
	J	2	γ	45°	45°	45°	J	2	α	37.5°	37.5°	37.5°	female	male	○
	K	2		-	70°	70°	K	2		32.5°	32.5°	32.5°	female	male	○
	L	2		-	80°	80°	L	2		70°	70°	70°	female	male	○
	M	2	δ	-	110°	-	M	2	-	-	-	-	female	male	●
	Y	3	-	-	-	-	Y	3	β	112.5°	126°	112.5°	male	female	●
		-	-	-	-			γ		100°	102°	147.5°			

Front view of a socket	Ref.	Nb of keys	Angles	Series			Ref.	Nb of keys	Angles	Series			Contact type		Note
				00	0M	1M				2M	3M	4M	Plug	Socket	
	R	5	α	-	-	-	R	5	α	-	-	-	male	female	●
			β	-	-	-			β	-	-	-			
			-	-	-	-			-	-	-	-			
			-	-	-	-			-	-	-	-			

Y SERIES
(OUTDOOR KEYED)

www.atd-shop.com



MAIN FEATURES:

1. Security of the push –pull self-latching system
2. Multipole types 2 to 26 contacts
3. Solder or PCB contacts (straight or elbow)
4. High Packing density for space saving
5. Multiple key options to avoid cross mating of similar connectors
6. Keying system (G key standard) for connector alignment
7. 360° screening for full EMC shielding
8. Rugged housing for extreme working conditions
9. IP Rating: IP68

PART SECTION SHOWING INTERNAL COMPONENTS

Y series

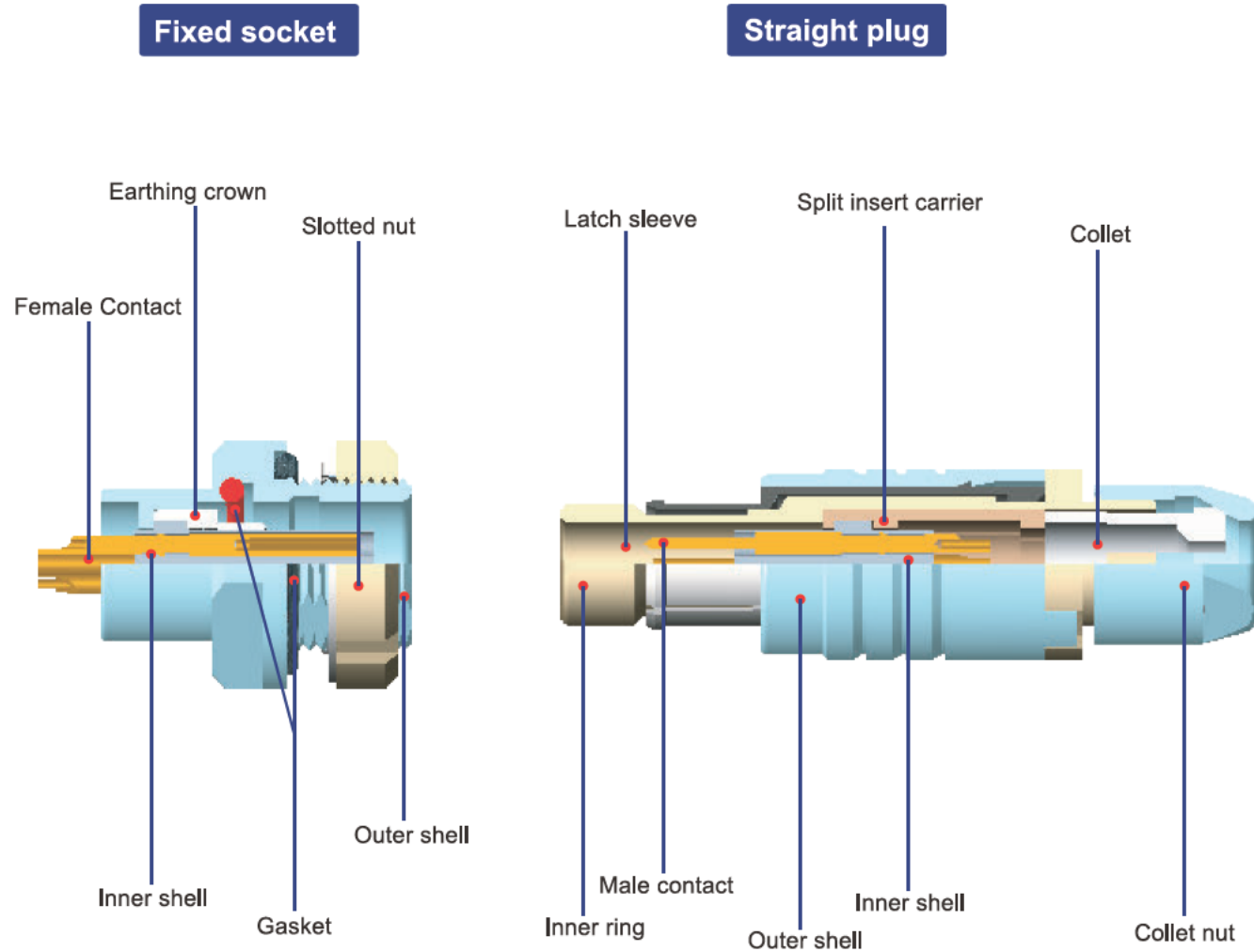

Part Numbering System

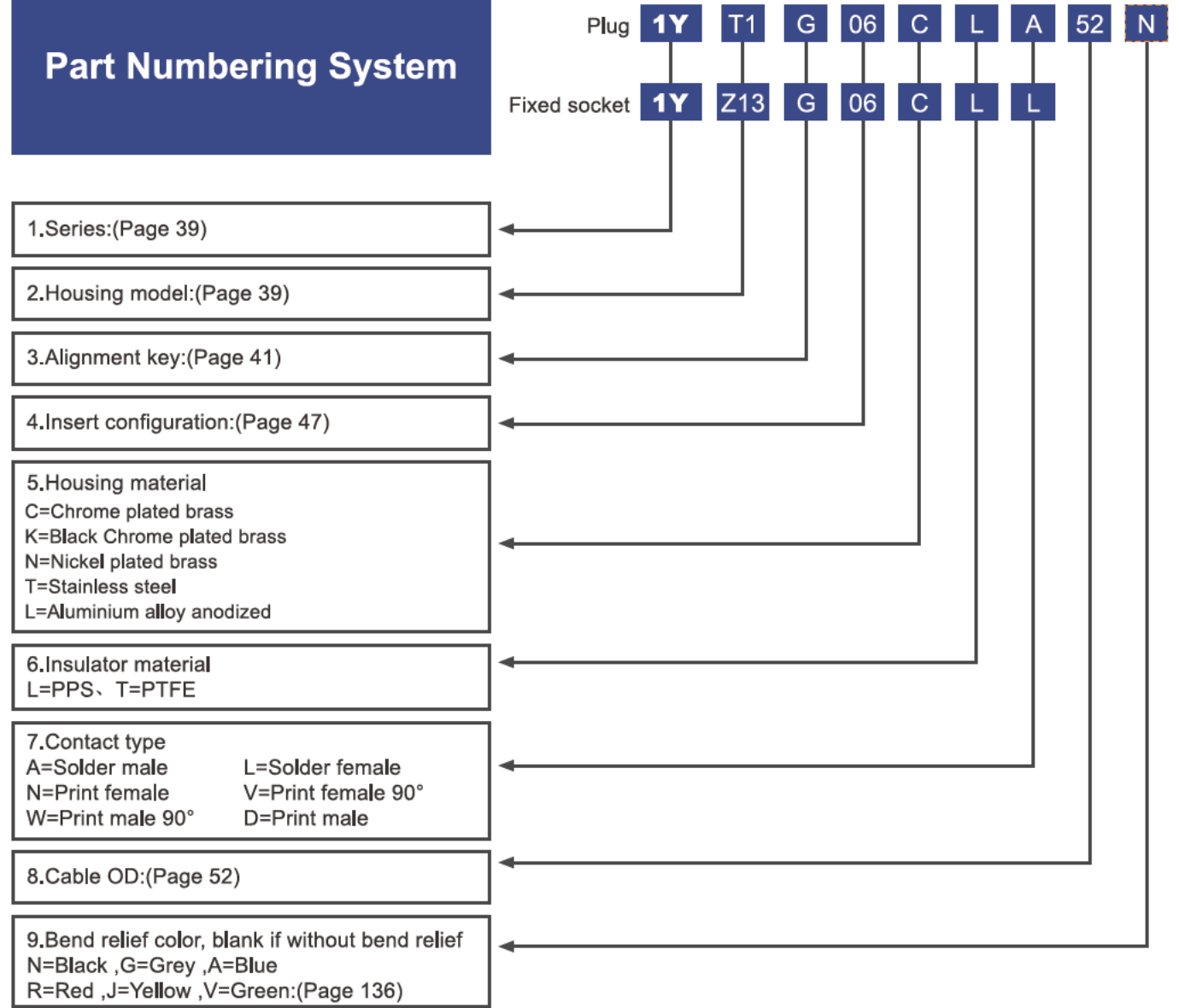

PART NUMBER EXAMPLE:

Straight plug with cable collet:

1YT1G04CLA52=1Y series straight plug with key(G) and cable collet, multipole type with 4 contact s, outer shell in chrome plated brass, PPS insulator, solder male contacts, collet for 5.0mm diameter cable.

Free socket:

1YZ13G04CLL=1Y series fixed socket, nut fixing, with key(G), multipole type with 4 contacts, outer shell in chrome plated brass, PPS insulator, solder female contacts.

TECHNICAL CHARACTERISTICS

Characteristics	Parameter
Locking Type	push pull self-latching type
Working Temperature	-55°~+250°
Maximum Humidity	up to 95% at 60°/140°F
Shielding Efficiency	75dB(10MHz) 40dB(1GHz)
Resistance to Vibration	15g[10Hz~2000Hz]

Characteristics	Parameter
Salt spray corrosion test	96hr
Shock resistance	100g,6ms
Endurance	5000 cycles
Protection index(mated)	IP68

外壳型号

T1 PLUG STRAIGHT PLUG, KEY (G) OR KEYS (A...F, L AND R), CABLE COLLET

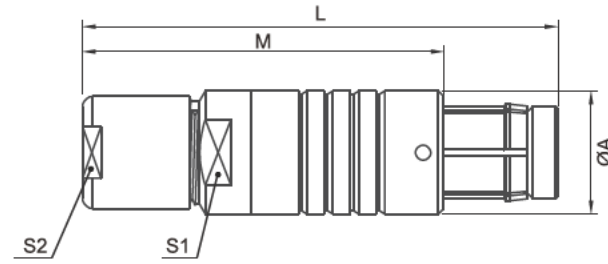

Reference		Dimensions(mm)				
Series	Model	L	M	A	S1	S2
00Y	T1	28	20	7.7	6	5
1Y	T1	45.8	34.8	11.8	10	9
2Y	T1	50.5	38.5	15	13	13

T1 PLUG STRAIGHT PLUG, KEY (G) OR KEYS (A...M), CABLE COLLET AND NUT FOR FITTING A BEND RELIEF

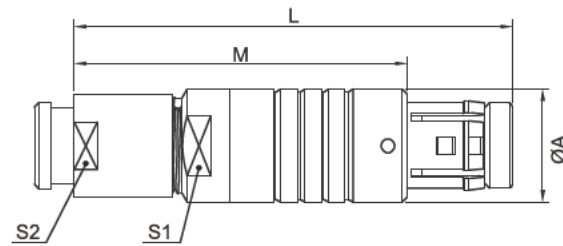

Reference		Dimensions(mm)				
Series	Model	L	M	A	S1	S2
00Y	T1	28	20	7.7	6	5
1Y	T1	45.8	34.8	11.8	10	9
2Y	T1	50.5	38.5	15	13	13

T3 PLUG ELBOW (90°) PLUG, KEY (G) OR KEYS(A...M AND R), CABLE COLLET

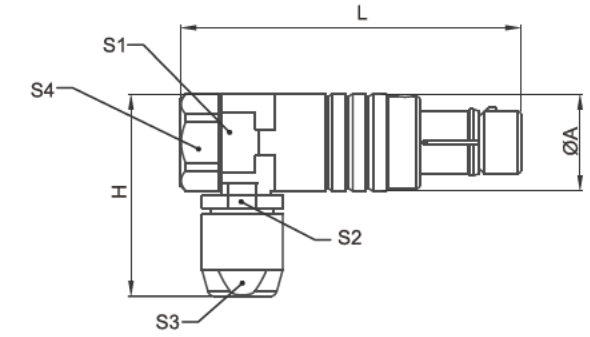

Reference		Dimensions(mm)						
Series	Model	A	L	H	S1	S2	S3	S4
00Y	T3	7.7	27	16	6	6	5	7

Z6 SOCKET FIXED SOCKET, FRONT PANEL MOUNT, NUT FIXING, KEY (G) OR KEYS (A...M), WATERTIGHT OR VACUUM-TIGHT

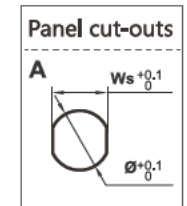
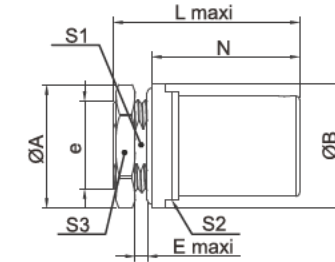

Reference		Dimensions(mm)									Panel cut-outs		
Series	Model	A	B	L	N	E	S1	S2	S3	e	Ws	Ø	Type
1Y	Z6	16	16	24.2	19.2	2	10	14	14	M12*1.0	10.6	12.1	A

Z13 SOCKET FIXED SOCKET, BACK PANEL MOUNT, NUT FIXING, KEY (G) OR KEYS (A...M), WATERTIGHT OR VACUUM-TIGHT

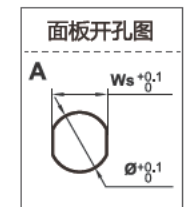
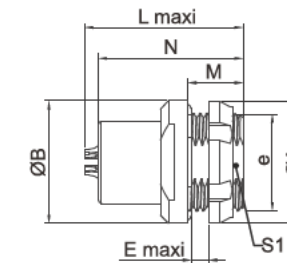

Reference		Dimensions(mm)									Panel cut-outs		
Series	Model	A	B	L	N	M	E	S1	e	Ws	Ø	Type	
00Y	Z13	10	9.8	15	12.5	5	2	6.3	M7*0.5	6.4	7.1	A	
1Y	Z13	18	17.8	25	21	8	4.5	8.2	M14*1.0	12.1	14.1	A	
2Y	Z13	20	21	25	20.4	10	5.5	10.5	M16*1.0	14.6	15.1	A	

K series Alignment Key and Polarized Keying System

Front view of a socket	Ref.	Nb of keys	Angles	Series			Ref.	Nb of keys	Angles	Series			Contact type		Note	
				00	0Y	1Y				2Y	3Y	4Y	Plug	Socket		
	G	1		0°	0°	0°	G	1		0°	0°	0°	male	female	●	
	A	2	α	30°	30°	30°	A	2	α	30°	30°	30°	male	female	●	
	B	2		60°	60°	60°	B	2		45°	45°	45°	male	female	●	
	C	2		-	90°	90°	C	2		60°	60°	60°	male	female	○	
	D	2	β	-	135°	135°	D	2	γ	95°	95°	95°	male	male	○	
	E	2		-	145°	145°	E	2		β	120°	120°	120°	male	male	○
	F	2		-	155°	155°	F	2			145°	145°	145°	male	male	●
	J	2	γ	45°	45°	45°	J	2	α	37.5°	37.5°	37.5°	female	male	○	
	K	2		-	70°	70°	K	2		32.5°	32.5°	32.5°	female	male	○	
	L	2		-	80°	80°	L	2		γ	70°	70°	70°	female	male	○
	M	2	δ	-	110°	-	M	2	-	-	-	-	female	male	●	
	Y	3	-	-	-	-	Y	3	β	112.5°	126°	112.5°	male	female	●	
									γ	100°	102°	147.5°				

Front view of a socket	Ref.	Nb of keys	Angles	Series			Ref.	Nb of keys	Angles	Series			Contact type		Note
				00	0Y	1Y				2Y	3Y	4Y	Plug	Socket	
	R	5	α	-	-	-	R	5	α	-	-	-	male	female	●
			β	-	-	-			β	-	-	-			
				-	-	-				-	-	-			

D SERIES (UNDERWATER CONNECTORS)

(OUTDOOR KEYED)



www.atd-shop.com



MAIN FEATURES:

1. Screw coupling system
2. Multipole types 2 to 13 contacts
3. Solder or PCB contacts (straight or elbow)
4. 360° screening for full EMC shielding
5. Multiple key options to avoid cross mating of similar connectors
6. Suitable for working under pressure 30bar

PART SECTION SHOWING INTERNAL COMPONENTS

D series

Fixed socket

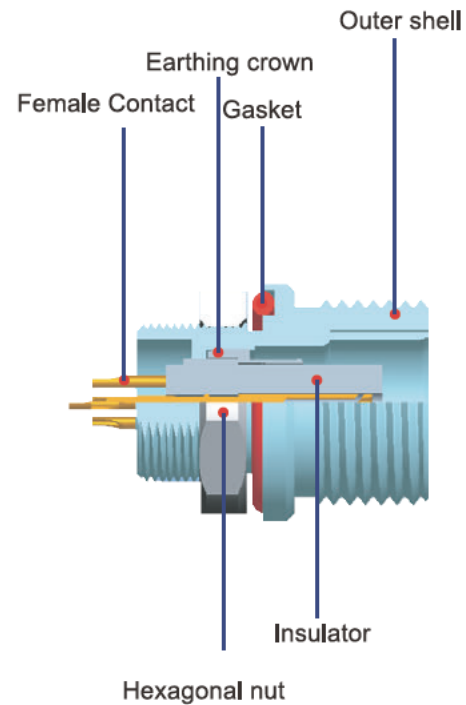

Straight plug

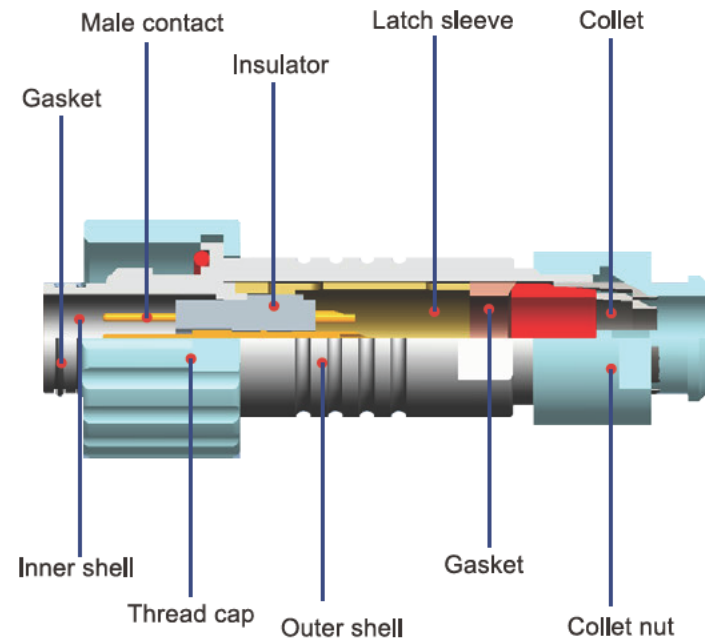

Part Numbering System

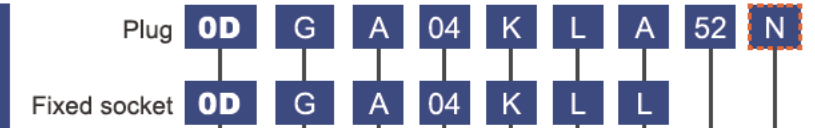

- 1.Series:(Page 45)
- 2.Housing model:(Page 45)
- 3.Alignment key:(Page 46)
- 4.Insert configuration:(Page 47)
- 5.Housing material
C=Chrome plated brass
K=Black Chrome plated brass
N=Nickel plated brass
T=Stainless steel
L=Aluminium alloy anodized
- 6.Insulator material
L=PPS, T=PTFE
- 7.Contact type
A=Solder male L=Solder female
N=Print female V=Print female 90°
W=Print male 90° D=Print male
- 8.Cable OD:(Page 52)
- 9.Bend relief color, blank if without bend relief
N=Black ,G=Grey ,A=Blue
R=Red ,J=Yellow ,V=Green:(Page 136)

PART NUMBER EXAMPLE:

Straight plug with cable collet:

ODT1G04CLA40N=0D series straight plug with key(G) and cable collet, multipole type with 4 contact s, outer shell in chrome plated brass, PPS insulator, solder male contacts, collet for 4.0mm diameter cable, with black bend relief..

Fixed socket:

0DZ1G02CLL=0D series fixed socket, nut fixing, with key(G) , multipole type with 2 contacts, outer shell in chrome plated brass, PPS insulator, solder female contacts.

TECHNICAL CHARACTERISTICS

Characteristics	Parameter
Locking Type	screw coupling type
Working Temperature	-55°~+250°
Maximum Humidity	up to 95% at 60°/140°F
Shielding Efficiency	75dB(10MHz) 40dB(1GHz)
Resistance to Vibration	15g[10Hz~2000Hz]

Characteristics	Parameter
Salt spray corrosion test	96hr
Shock resistance	100g,6ms
Endurance	5000 cycles
Protection index(mated)	IP68
Resistance to hybrositic pressure(mated)	30 bars

Housing Models

T1 PLUG STRAIGHT PLUG, CABLE COLLET AND NUT FOR FITTING A BEND RELIEF

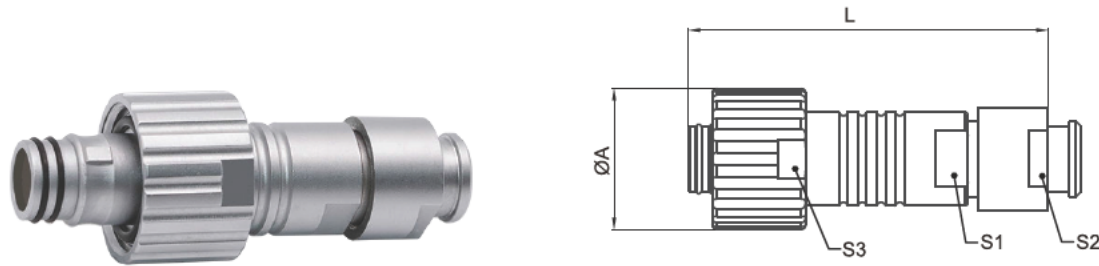

Reference		Dimensions(mm)				
Series	Model	L	A	S1	S2	S3
0D	T1	38.3	15	8.5	9.0	14

Z7 SOCKET FIXED SOCKET, FRONT PANEL MOUNT, NUT FIXING

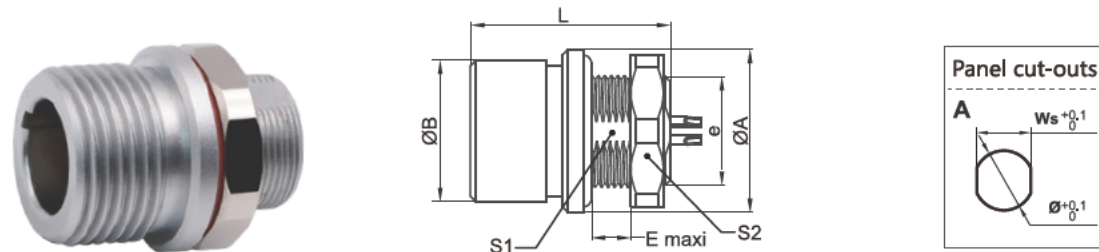

Reference		Dimensions(mm)							Panel cut-outs		
Series	Model	L	A	B	E	S1	S2	e	Ws	Ø	Type
0D	Z1	18.5	15.0	13.0	4.0	9.0	14.0	M10*0.5	9.1	10.1	A

D series Alignment Key and Polarized Keying System

Front view of a socket	Ref.	Nb of keys	Angles	Series			Ref.	Nb of keys	Angles	Series			Contact type		Note	
				00	0D	1D				2D	3D	4D	Plug	Socket		
	G	1		0°	0°	0°	G	1		0°	0°	0°	male	female	●	
	A	2		30°	30°	30°	A	2		30°	30°	30°	male	female	●	
	B	2	α	60°	60°	60°	B	2	α	45°	45°	45°	male	female	●	
	C	2		-	90°	90°	C	2		60°	60°	60°	male	female	○	
	D	2		-	135°	135°	D	2	γ	95°	95°	95°	male	female	○	
	E	2	β	-	145°	145°	E	2	β	120°	120°	120°	male	female	○	
	F	2		-	155°	155°	F	2		145°	145°	145°	male	female	●	
	J	2		45°	45°	45°	J	2	α	37.5°	37.5°	37.5°	female	male	○	
	K	2	γ	-	70°	70°	K	2	α	32.5°	32.5°	32.5°	female	male	○	
	L	2		-	80°	80°	L	2	γ	70°	70°	70°	female	male	○	
	M	2	δ	-	110°	-	M	2	-	-	-	-	female	male	●	
	Y	3						3		β	112.5°	126°	112.5°	male	female	●
											γ	100°	102°			

Front view of a socket	Ref.	Nb of keys	Angles	Series			Ref.	Nb of keys	Angles	Series			Contact type		Note				
				00	0D	1D				2D	3D	4D	Plug	Socket					
	R	5					R	5					male	female	●				
																α	-	-	-
																β	-	-	-
																γ	-	-	-

INSERT CONFIGURATION (Multipole)

Series	Code	Solder contacts		Contact ϕ (mm)	Resistance (m Ω)	Rated current (A)	Test voltage (V)	Working voltage (V)
		Male	Female					
00B 00Y	02			0.5	10	5	1000	330
	03			0.5	10	3	800	260
	04			0.5	10	2	800	260
	05			0.35	10	1.7	700	200
0B 0K 0M 0D	02			0.9	6	10	1000	500
	03			0.9	6	8	875	400
	04			0.7	7.5	7	875	300
	05			0.7	7.5	6.5	750	300
	06			0.5	10	2.5	750	300
	07			0.5	10	2.5	750	300
09			0.5	10	2	600	200	
	13			0.4	10	2	600	200
1B 1K 1M 1Y	02			1.3	5	15	1500	500
	03			1.3	5	12	1300	430
	04			0.9	6	10	1300	430

INSERT CONFIGURATION (Multipole)

Series	Code	Solder contacts		Contact ϕ (mm)	Resistance (m Ω)	Rated current (A)	Test voltage (V)	Working voltage (V)
		Male	Female					
1B 1K 1M 1Y	05			0.9	6	9	1250	415
	06			0.7	7.5	7	1050	350
	06 (4+2)			0.9*4	6.0	10	1050	350
				0.5*2		2		
	07			0.7	7.5	7	950	315
	08			0.7	7.5	5	950	315
	10			0.5	10	2.5	900	300
	12			0.5	10	2	800	260
	14			0.5	10	2	800	260
	16			0.5	10	1.5	800	260
2B 2K 2Y	02			2.0	3	25	2100	700
	03			1.6	4	17	2400	800
	04			1.3	5	15	1850	810
	05			1.3	5	14	1750	580
	06			1.3	5	12	1350	450
	07			1.3	5	11	1750	580
	08			0.9	6	10	1500	500
				0.5		2		

INSERT CONFIGURATION (Multipole)







Series	Code	Solder contacts		Contact ø(mm)	Resistance (mΩ)	Rated current (A)	Test voltage (V)	Working voltage (V)
		Male	Female					
2B 2K 2Y	10			0.9	6	8	1450	500
	12			0.7	7.5	7	1250	480
	14			0.7	7.5	6.5	1150	380
	16			0.7	7.5	6	950	315
	18			0.7	7.5	5.5	850	280
	19			0.7	7.5	5	875	280
	26			0.5	10	2	950	315
3B-3K	02			3.0	6	35	2100	700
	03			2.0	3	25	1900	650
	04			2.0	3	19	1500	550
	05			1.6	4	19	1900	650
	06			1.6	4	17	1600	533
	07			1.6	4	15	1700	550
	08			1.3	5	13	1650	550
	09 (8+1)			1.3*8	5	6.0	1350	450
				2.0*1		15.0		

INSERT CONFIGURATION (Multipole)

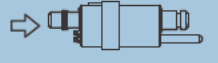
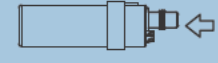







Series	Code	Solder contacts		Contact ø(mm)	Resistance (mΩ)	Rated current (A)	Test voltage (V)	Working voltage (V)
		Male	Female					
3B-3K	10			1.3	5	12	1250	415
	12			0.9	6	9	1450	450
	14			0.9	6	9	1200	400
	16			0.9	6	8	1200	395
	18			0.9	6	7	1200	395
	20			0.7	7.5	6	1000	395
	22			0.7	7.5	5.5	1000	330
	24			0.7	7.5	4	950	333
	26			0.7	7.5	4	950	315
	30			0.7	7.5	3.5	800	270
3B	X112 (11+2)			0.75*11	7.5	6	1500	500
				1.1*2	5	10	4000	1300

CALCULATION METHOD: WORKING VOLTAGE= TEST VOLTAGE/3

INSERT CONFIGURATION (Multi fluid and Mixed fluid + LV)

Series	Code	Number of contacts	Solder contacts		Contact ø(mm)	Ext. ø of tube (mm)	Int. ø of tube (mm)	Max. working pressure(bars)	Working voltage (V)	Rated current (A)
			Male solder contacts	Female solder contacts						
2B 2K	P13	6			0.7	3.0 4.0	1.8 3.0	6	1600	6.0
		1 Fluidi								
3B 3K	801	8			0.7	3.0 4.0	1.8 3.0	10	800	8.0
		1 Fluidi								

INSERT CONFIGURATION (Coaxial hybrid)

Series	Code	Number of contacts	Solder contacts		Contact ø(mm)	Resistance (mΩ)	Rated current (A)	Test voltage (V)	Working voltage (V)	Impedanc (Ω)
			Male	Female						
2B 2K	804	4			0.7	7.5	7	750	250	-
		1 Coax			1.3	5	15	1850	610	50
3B 3K	813	13			0.7	6	7	900	300	-
		1 Coax			1.3	5	15	1850	610	50

COLLET (B, K, M, Y, D SERIES) (The material of collet is nickel plated brass)

FOR B,D SERIES



Code	ColletØA (mm)	Cable DiaØ(mm)		Series				
		min.	max.	00B	0B/0D	1B	2B	3B
30	3.0	2.6	3.0	●		●	●	
35	3.5	3.1	3.5	●	●			
40	4.0	3.4	4.0		●	●	●	
50	5.0	4.6	5.0		●	●	●	●
60	6.0	5.1	6.0			●	●	●
70	7.0	6.1	7.0			●	●	●
80	8.0	7.1	8.0				●	●
90	9.0	8.1	9.0				●	●
10	10.0	9.1	10.0				●	●
11	11.0	10.1	11.0					●

FOR K, M SERIES



Code	ColletØA (mm)	Cable DiaØ(mm)		Series			
		min.	max.	0K/0M	1K/1M	2K	3K
30	3.0	2.6	3.0	●			
35	3.5	3.1	3.5	●			
40	4.0	3.6	4.0	●	●		
50	5.0	4.6	5.0		●	●	
55	5.5	5.1	5.5	●	●		
60	6.0	5.6	6.0		●	●	
70	7.0	6.1	7.0		●	●	●
80	8.0	7.1	8.0			●	●
90	9.0	8.1	9.0			●	●
10	10.0	9.1	10.0				●
11	11.0	10.1	11.0				●

FOR Y SERIES



Code	ColletØA (mm)	Cable DiaØ(mm)		Series		
		min.	max.	00Y	1Y	2Y
30	3.0	2.6	3.0	●	○	
35	3.5	3.1	3.5	●		
40	4.0	3.6	4.0		○	
50	5.0	4.6	5.0		○	
60	6.0	5.6	6.0		○	●
77	7.7	7.1	7.7			●

○ Protection index(mated):IP50&IP68
● Protection index(mated):IP68

PCB Drilling pattern For B Series and K Series fixed socket with straight prin contacts

02

Series	Dimensions(mm)	
	A	B
00	0.6	1.2
0B-0K	0.7	2.2
1B-1K	0.7	2.8
2B-2K	0.7	4.4

03

Series	Dimensions(mm)		
	A	B	C
00	0.6	1.35	120°
0B-0K	0.7	2.30	120°
1B-1K	0.7	3.00	120°
2B-2K	0.7	4.60	120°
3B-3K	0.8	5.60	120°

04

Series	Dimensions(mm)		
	A	B	C
00	0.6	1.7	45°
0B-0K	0.7	2.5	45°
1B-1K	0.7	3.1	45°
2B-2K	0.7	5.0	45°
3B-3K	0.8	6.2	45°

05

Series	Dimensions(mm)		
	A	B	C
0B-0K	0.7	2.8	72°
1B-1K	0.7	3.4	72°
2B-2K	0.7	5.2	72°
3B-3K	0.8	6.7	72°

06

Series	Dimensions(mm)		
	A	B	C
0B-0K	0.7	3.0	60°
1B-1K	0.7	3.7	60°

06

Series	Dimensions(mm)		
	A	B	C
2B-2K	0.7	5.6	72°

07

Series	Dimensions(mm)		
	A	B	C
0B-0K	0.7	3.0	60°
1B-1K	0.7	3.7	60°
2B-2K	0.7	5.8	60°

08

Series	Dimensions(mm)		
	A	B	C
1B-1K	0.7	3.8	51°26'

08

Series	Dimensions(mm)		
	A	B	C
2B-2K	0.7	6.4	45°
3B-3K	0.8	7.5	45°

09

Series	Dimensions(mm)		
	A	B	C
0B-0K	0.7	3.2	45°

10

Series	Dimensions(mm)				
	A	B	C	D	H
1B-1K	0.7	3.95	45°	22°30'	1.40
2B-2K	0.7	6.2	45°	22°30'	2.40
3B-3K	0.8	7.9	45°	22°30'	2.80

12

Series	Dimensions(mm)				
	A	B	C	D	H
2B-2K	0.7	6.5	45°	22°30'	2.80
3B-3K	0.7	8.2	45°	22°30'	3.40

14

Series	Dimensions(mm)				
	A	B	C	H	I
1B-1K	0.7	4.4	90°	1.90	1.80
2B-2K	0.7	6.5	90°	3.65	2.65
3B-3K	0.7	8.2	90°	3.40	3.40

16

Series	Dimensions(mm)				
	A	B	C	D	H
1B-1K	0.7	4.4	72°	32°44'	2.00

NOTE : ALL VIEWS ARE FROM THE SIDE OF THE SOCKET.

PCB Drilling pattern For B Series and K Series fixed socket with straight prin contacts

16

Series	Dimensions(mm)				
	A	B	D	E	H
2B-2K	0.7	6.7	32°44'	16°22'	3.30
3B-3K	0.7	8.4	32°44'	16°22'	3.86

18

Series	Dimensions(mm)					
	A	B	D	E	H	
2B-2K	0.7	6.7	60°	30°	15°	3.5
3B-3K	0.7	8.4	60°	30°	15°	4.4

19

Series	Dimensions(mm)					
	A	B	C	D	H	
2B-2K	0.7	6.7	60°	30°	15°	3.5

20

Series	Dimensions(mm)				
	A	B	C	D	H
3B-3K	0.7	8.62	51°26'	27°42'	4.78

22

Series	Dimensions(mm)					
	A	B	C	D	H	
3B-3K	0.7	8.8	45°	25°43'	22°30'	5

24

Series	Dimensions(mm)					
	A	B	C	D	H	
3B-3K	0.7	8.8	45°	51°26'	1.8	5.3

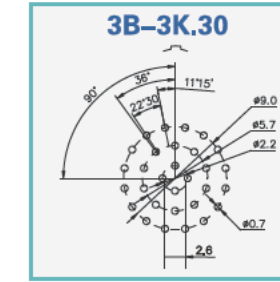
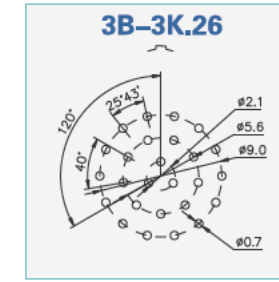
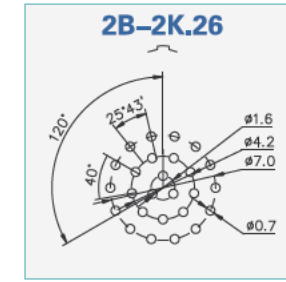

NOTE : ALL VIEWS ARE FROM THE SIDE OF THE SOCKET.

Straight print contacts length (Z1/Z2/Z3/Z5 models)

Number of contact	Dimension(mm)		
	ØC	L	
00	0.5	3.0	
0B 0K	02/03	0.6	3.2
	04/05	0.5	3.5
	06/07/09	0.6	3.2
	13	0.5	3.5
1B 1K	02/03/04/05/06/07/08/10/12/14/16	0.6	3.2
2B 2K	02/03/04/05/06/07/08/10/12/14/16/18/19/26	0.6	3.0
3B 3K	02/03/04/05/06/07/08/10/12/14/16/18	0.7	3.0
	20/22/24/26/30	0.6	3.2

Z1/Z2/Z3/Z5

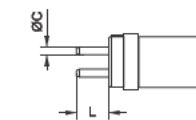

PCB Drilling pattern

For B Series and K Series fixed socket with 90° print contacts

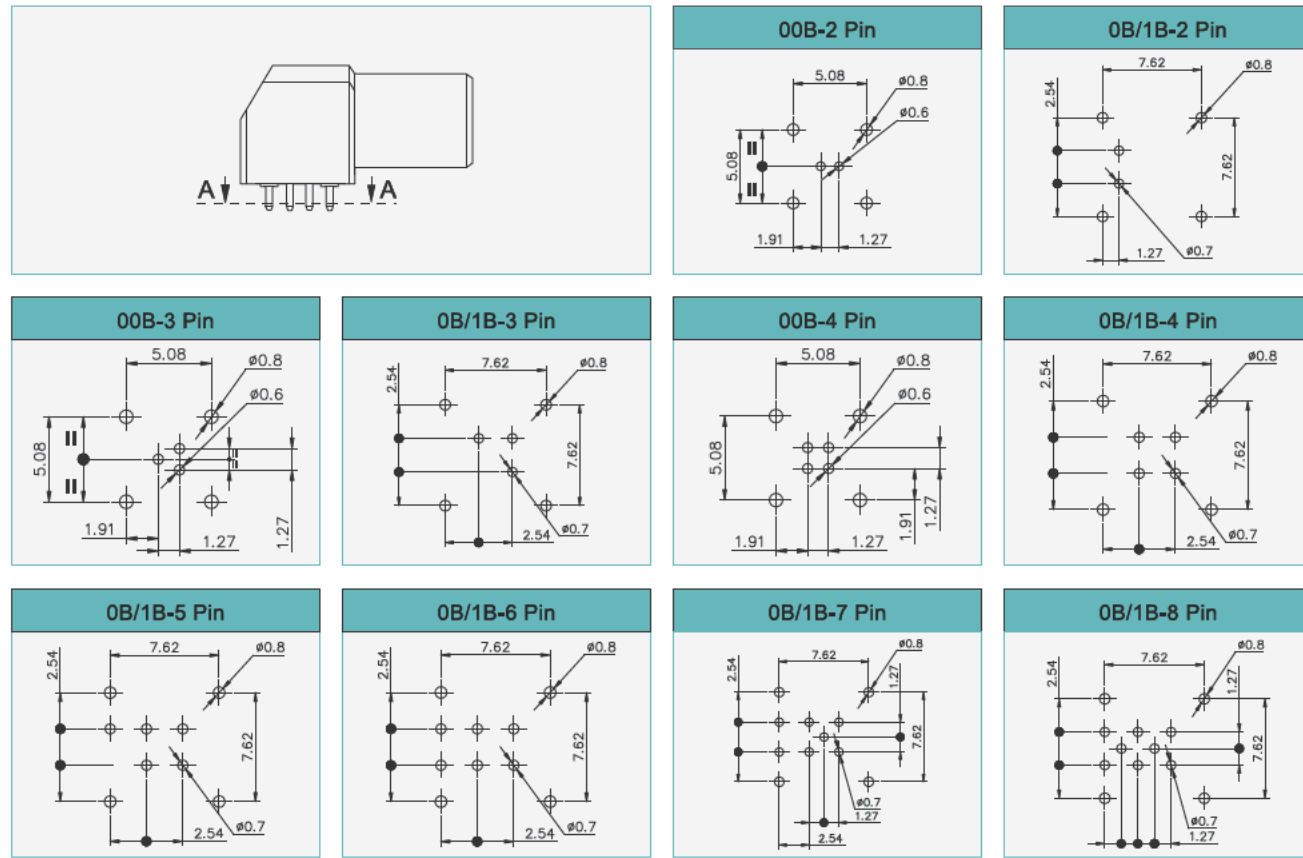

PCB Drilling pattern

For B Series and K Series fixed socket with 90° print contacts

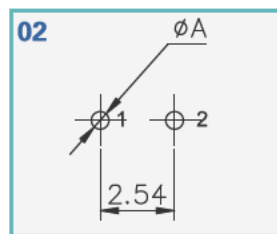
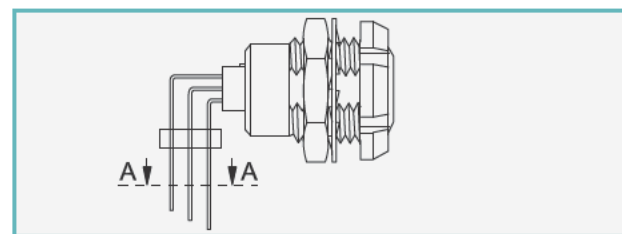

Series	Dimensions(mm)
	A
00	0.6
0B-0K	0.7
1B-1K	0.7
2B-2K	0.7

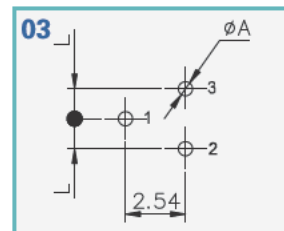

Series	Dimensions(mm)	
	A	L
00	0.6	1.27
0B-0K	0.7	1.27
1B-1K	0.7	1.27
2B-2K	0.7	2.54

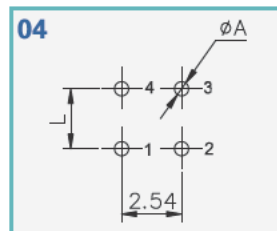

Series	Dimensions(mm)	
	A	L
00	0.6	2.54
0B-0K	0.7	2.54
1B-1K	0.7	2.54
2B-2K	0.7	3.50

NOTE : ALL VIEWS ARE FROM THE SIDE OF THE SOCKET.

PCB Drilling pattern

For B Series and K Series fixed socket with 90° print contacts

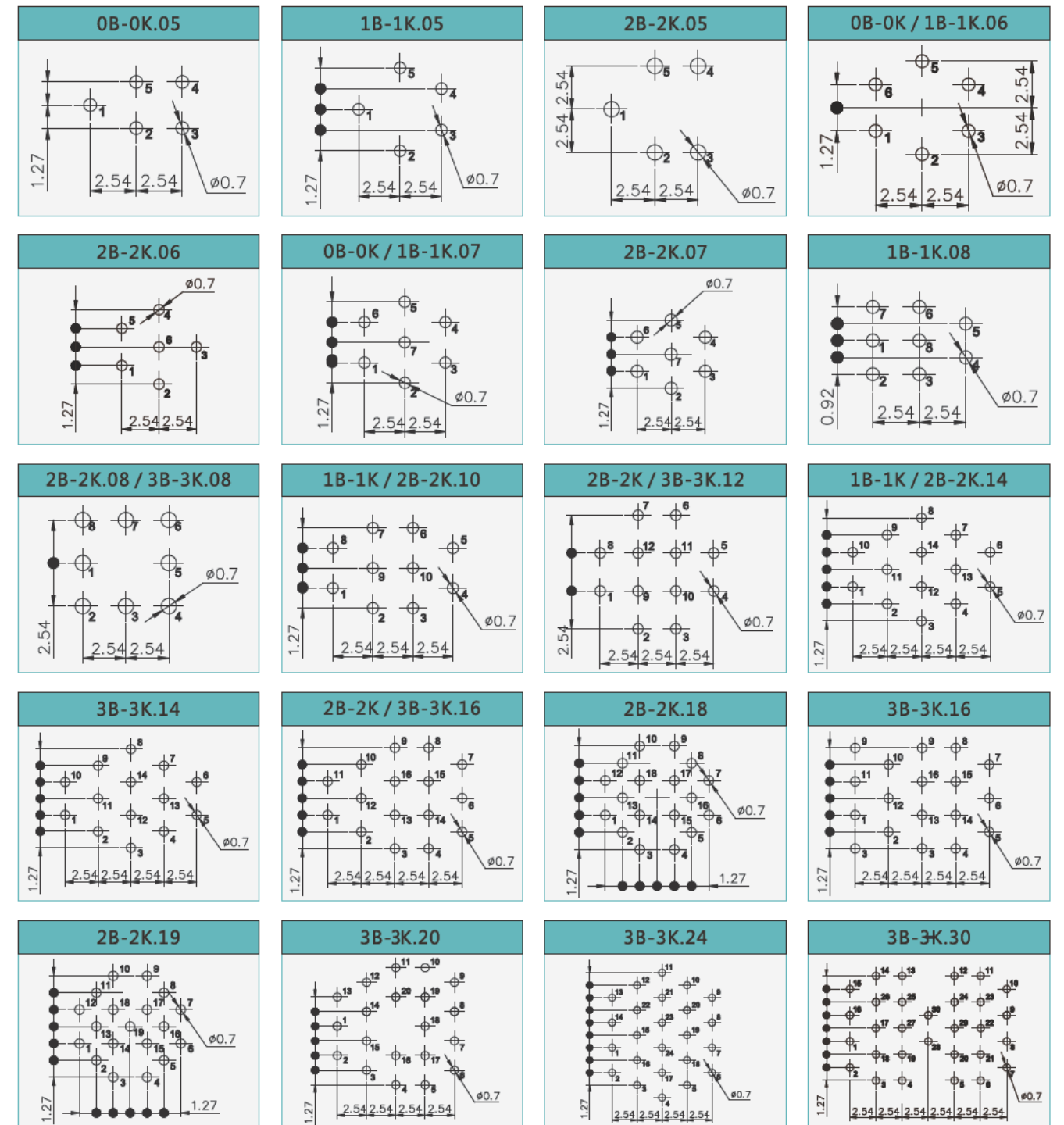

NOTE : ALL VIEWS ARE FROM THE SIDE OF THE SOCKET.