

ME030 PCB Connector, Header

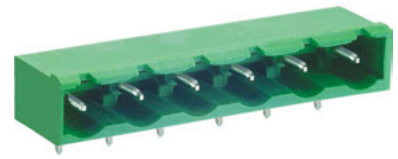
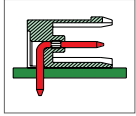

DIMENSIONS/POSITIONS

DIMENSIONS/POSITIONS		ME030-508	ME030-762
間距	Pitch	5.08mm	7.62mm
位數	Poles	2 ~ 24Poles	2 ~ 16Poles
尺寸a	Dimension a	5.08mm	7.62mm
長度 A	Length	A= 5.08xP+1.60mm(P≥2)	A= 7.62xP(P≥2)
塑膠本體	Housing Material	PA 66	PA 66
焊針	Pin Dimensions	Brass, Tin Plated	Brass, Tin Plated
PCB孔徑	PCB Hole Diameter	1.5mm	1.5mm
環境作業溫度	Operating Temperature	-40°C to +105°C	-40°C to +105°C

TECHNICAL DATA

連接符合標準 Connection in acc. with standard EN-VDE			
額定電流 I _N	Nominal Current I _N	16A	16A
額定橫截面	Nominal Cross Section	-	-
最大負載電流	Maximum load current	16A	16A
絕緣材料	Insulating Material	PA	PA
阻燃等級, 符合UL94 Inflammability class acc. to UL94		V0	V0
額定電壓, UL/CUL Nominal voltage, UL/CUL		300V	300V
額定電流, UL/CUL Nominal current, UL/CUL		16A	15A

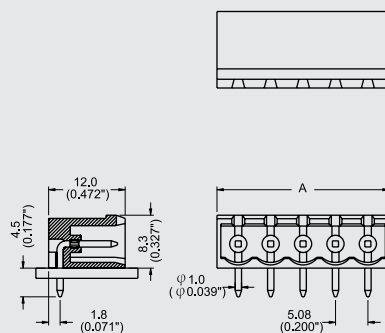

PCB Layout

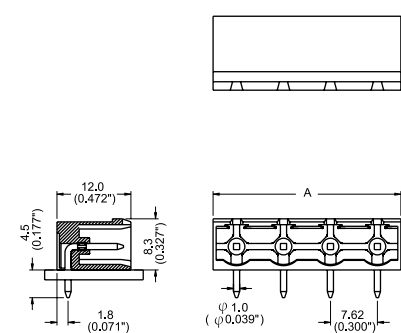
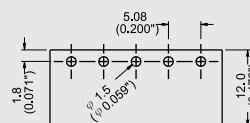

PCB Layout

