

## 5.1 EMC / HF Gaskets

E | 5\_2

5.1.1 EMC Contact Springs (A)

E | 5\_2

5.1.2 EMC Contact Strips (A)

E | 5\_2

5.1.3 HF Gaskets (A)

E | 5\_3

5.1.4 EMC Gaskets (B) Stainless Steel

E | 5\_3

5.1.5 EMC Gaskets (B) Foam Core

E | 5\_3

5.1.6 EMC Contact Strips (B)

E | 5\_4

5.1.7 HF Spring (C)

E | 5\_4

5.1.8 EMC Contact Strips (C)

E | 5\_4

5.1.9 EMC Contact Strips(D)

E | 5\_4

5.1.10 HF Gasket

E | 5\_5

5.1.11 Sealing Gasket

E | 5\_5

# 5: EMC / HF Gaskets



## 5.1 EMC / HF Gaskets

### 5.1.1 EMC Contact Springs (A)

#### 5.1.1 EMC Contact Springs (A)

- Stainless steel
- Side front panel to end side panel
- EMC dividing extrusion 66-266
- Self-adhesive

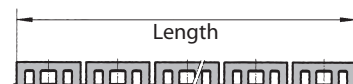
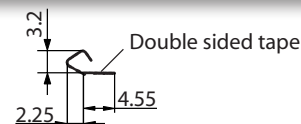

For Size	Length		Packing Units	Part-No.
	mm	inch		
2 U	58	2.32	2 pcs.	63-873-03
3 U	107	4.28	2 pcs.	63-873-01
6 U	2 x 107	2 x 4.28	4 pcs.	63-873-02
4 U	146.2	5.88	2 pcs.	63-873-04
6 U	244.2	9.77	2 pcs.	63-873-05

### 5.1.2 EMC Contact Strips (A)

#### 5.1.2 EMC Contact Strips (A)

- BeCu galvanised
- Side front panel to end side panel
- Self-adhesive

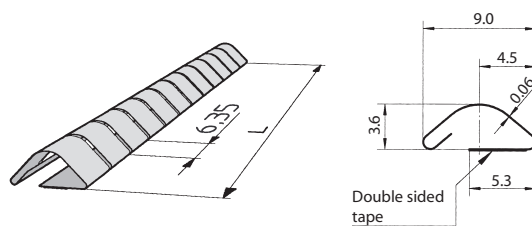

Division	For Size	Length		Packing Units	Part-No.
		mm	inch		
17	3 U	108	4.32	2 pcs.	63-836-53
24	4 U	152.4	6.00	2 pcs.	63-836-54
38	6 U	241.3	9.65	2 pcs.	63-836-56
45	7 U	285.8	11.42	1 pc.	61-800-07
66	10 U / 84 HP	419.1	16.76	1 pc.	61-800-10

# 5: EMC / HF Gaskets

## 5.1.3 HF Gaskets (A)

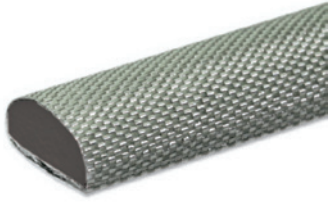

### 5.1.3.1 HF Gaskets (A)

- D-shaped
- Polyurethane foam core
- Conductive fabric (Ni+Cu plated)
- Self-adhesive

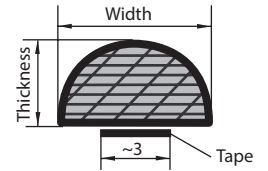

Width		Thickness		Length		Packing Units	Part-No.
mm	inch	mm	inch	mm	inch		
6.35	0.25	3.56	0.14	142.5	5.6	1 pc.	7820-90
				245.0	9.65	1 pc.	7820-91
				88.0	3.46	1 pc.	7820-92

## 5.1.4 EMC Gaskets (B) Stainless Steel

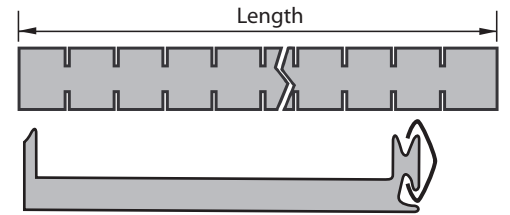

### 5.1.4 EMC Gasket (A and B)

- Stainless steel

For size	Length		Part-No.
	mm	inch	
2 U	57.15	2.25	81-062-02
3 U	101.6	4.00	81-062-03
4 U	146.05	5.75	81-062-04
6 U	234.95	9.25	81-062-06
7 U	279.4	11.00	81-062-07
8 U	323.85	12.75	81-062-08
9 U	368.3	14.50	81-062-09

## 5.1.5 EMC Gaskets (B) Foam Core

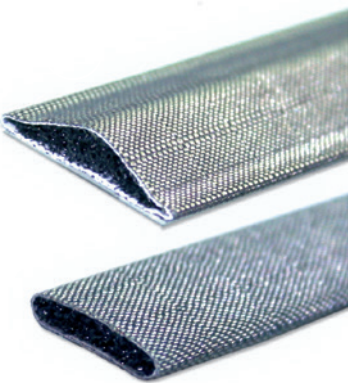

### 5.1.5 EMC-Gaskets (B)

- Polyurethane foam core
- Conductive fabric (Ni+Cu plated)
- Self-adhesive

Description	Part-No.
EMC-gasket rectangular. 2.0 x 7 mm, L = 300 mm	7820-95
EMC-gasket triangular. 2.3 x 10 mm, L = 300 mm	7821-300
EMC-gasket triangular. 2.3 x 10 mm, L = 2000 mm	7821-2000

# 5: EMC / HF Gaskets

## 5.1.6 EMC Contact Strips (B)

### 5.1.6 EMC Contact Strips (B)

- BeCu galvanised
- For part front panels
- Self-adhesive

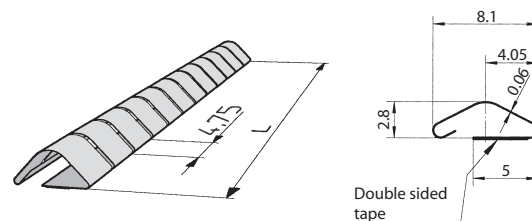

Division	For Size	Length		Packing Units	Part-No.
		mm	inch		
17	3 U	80.4	3.16	1 pc.	7738-13
45	6 U	213.4	8.40	1 pc.	7738-16

## 5.1.7 HF Spring (C)

### 5.1.7 HF Spring (C)

- Stainless steel
- Snapped-in on the extrusion
- **Scope of delivery:**
  - 2 pcs. HF spring 84 HP

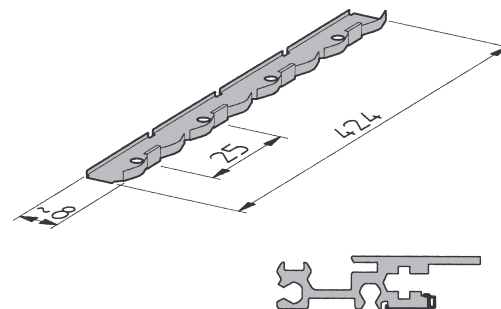

Description	Part-No.
1 set of 2 HF spring 84 HP	7739-14-4

## 5.1.8 EMC Contact Strips (C)

### 5.1.8 EMC Contact Strips (C)

- BeCu galvanised
- For front panels, fixing on extrusion
- Self-adhesive
- **Scope of delivery:**
  - 2 pcs. EMC contact strips

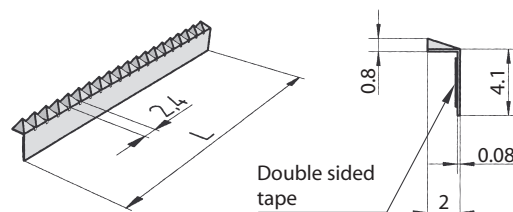

For HP	Length		Part-No.
	mm	inch	
42	212.1	8.35	63-836-67
63	318.1	12.52	63-836-68
84	424.2	16.70	63-836-70

## 5.1.9 EMC Contact Strips(D)

### 5.1.9 EMC Contact Strips (D)

- BeCu galvanised
- Self-adhesive

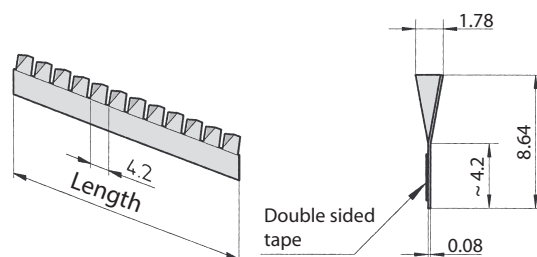

Division	For Size	Length		Packing Units	Part-No.
		mm	inch		
103	84 HP	431.55	16.99	1 pc.	7739-37

# 5: EMC / HF Gaskets

## 5.1.9.1 EMC Contact Strips

- For fixing on flat front panels
- Self-adhesive

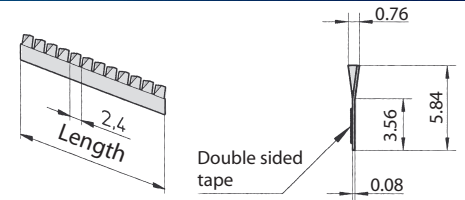

Division	For Size	Length		Packing Units	Part-No.
		mm	inch		
12	-	29	1.14	1 pc.	7739-31
178	84 HP	429.5	16.91	2 pc.	63-836-80

## 5.1.10 HF Gasket

### 5.1.10 HF Gasket

- Neoprene foam core
- Aluminium cover
- Self-adhesive

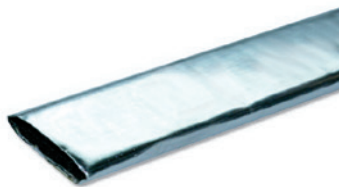
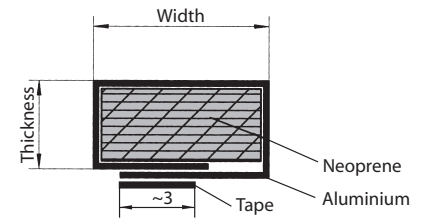

Width		Thickness		Length		Packing Units	Part-No.		
mm	inch	mm	inch	mm	inch				
7	0.27	2	0.07	30	1.18	16 pcs.	63-836-30		
				115	4.50	1 pc.	7820-27		
				195	7.67	4 pcs.	63-836-10		
				236	9.29	4 pcs.	63K836-15		
				245	9.65	1 pc.	7820-22		
				255	10.04	4 pcs.	63-836-11		
				316	12.44	4 pcs.	63K836-16		
				345	13.58	4 pcs.	63K836-04		
				395	15.55	1 pc.	7820-26		
				430	16.93	1 pc.	7820-21		
				445	17.52	4 pcs.	63K836-05		
				3	0.12	216.5	8.52	4 pcs.	63-836-20
						323	12.72	4 pcs.	63-836-21
						430	16.93	4 pcs.	63-836-23

## 5.1.11 Sealing Gasket

- For higher IP-protection and EMC shielding in one
- Conductive sealing
- **Scope of delivery:**
  - 1 sealing gasket (conductive)



### 5.1.11 Sealing Gasket

Description	Part-No.
Sealing gasket conductive, length 700 mm	33E025

