

1: 19" Front Panels

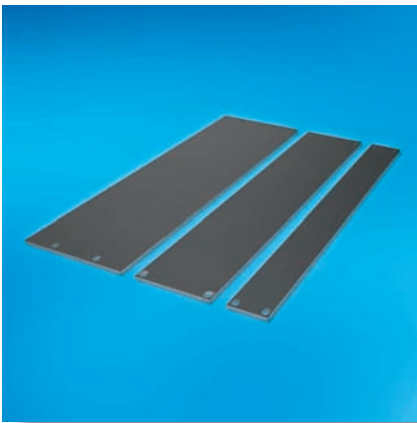

1.1 Front Panels 19"

1.1.1 Front/Rear Panels 19", Solid, Anodised



1.1.1 Front/Rear Panels 19", Solid, Anodised

- Aluminium 3 mm
- **Scope of delivery:**
 - 1 front panel
- Assembly material see 1.1.4

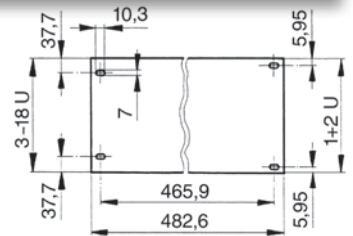

Height for	mm		Part-No. clear anodised
	mm	inch	
1 U	43.6	1.71	20-101
2 U	88.1	3.46	20-102
3 U	132.5	5.21	20-103
4 U	177.0	6.96	20-104
5 U	221.5	8.72	20-105
6 U	266.0	10.47	20-106
7 U	310.5	12.22	20-107
8 U	355.0	13.97	20-108
9 U	399.0	15.70	20-109
10 U	443.5	17.46	20-110
12 U	532.5	20.96	20-112

1.1.2 Front/Rear Panels 19", Solid, Powder Coated

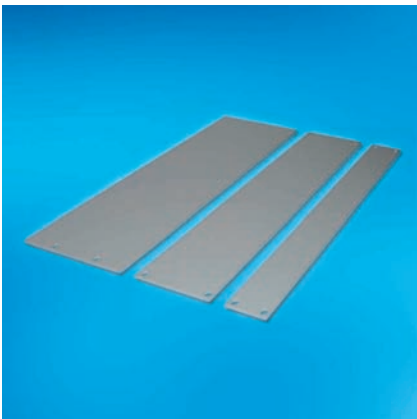

1.1.2 Front/Rear Panels 19", Powder Coated

- Aluminium 3 mm
- Rear conductive
- **Scope of delivery:**
 - 1 front panel
- Assembly material see 1.1.4

Height for	mm		Part-No.	
	mm	inch	Light-grey RAL 7035	Black RAL 9005
1 U	43.6	1.71	20-101-30	20-101-60
2 U	88.1	3.46	20-102-30	20-102-60
3 U	132.5	5.21	20-103-30	20-103-60
4 U	177.0	6.96	20-104-30	20-104-60
5 U	221.5	8.72	20-105-30	20-105-60
6 U	266.0	10.47	20-106-30	20-106-60

Other colours and heights available upon request

1: 19" Front Panels

1.1.3 Fan Front Panels 19"

- Aluminium 3 mm
- Clear anodised
- **Scope of delivery:**
 - 1 front panel
- Assembly material see below



1.1.3 Fan Front Panels 19"

Height for	mm		Air passage		Part-No. clear anodised
	mm	inch	mm ²	sq. in.	
1 U	43.6	1.71	8643	13.39	20-101-01
2 U	88.1	3.46	17286	26.79	20-102-01
3 U	132.5	5.21	28811	44.65	20-103-01

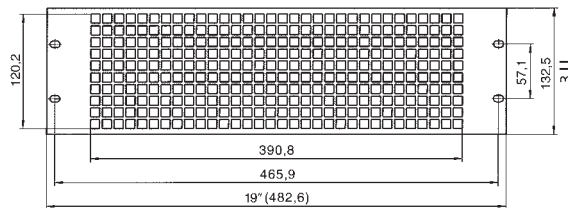
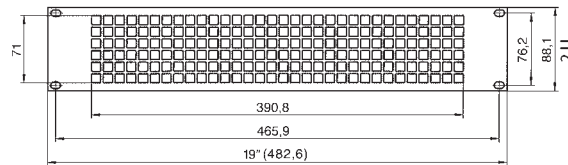
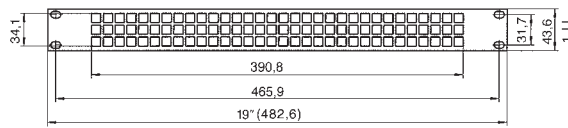

1.1.4 Assembly Material

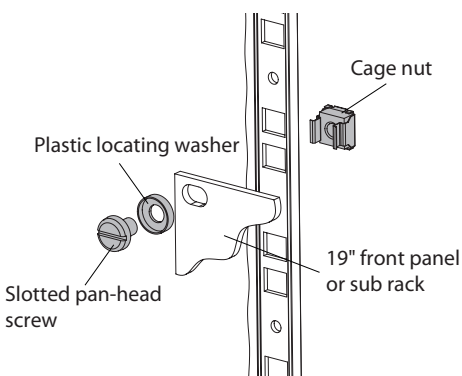

1.1.4 Assembly Material

- For mounting front panels in cabinets

Description	Part-No. 1 pc.	Part-No. 100 pcs.
Slotted pan-head screw M6 x 8	5561-08	1901-51
Slotted pan-head screw M6 x 12	5561-12	1901-52
Plastic locating washer	61-007	63-090
Cage nut M6	5625-06	5625-06-2