

# HK

Technical characteristics

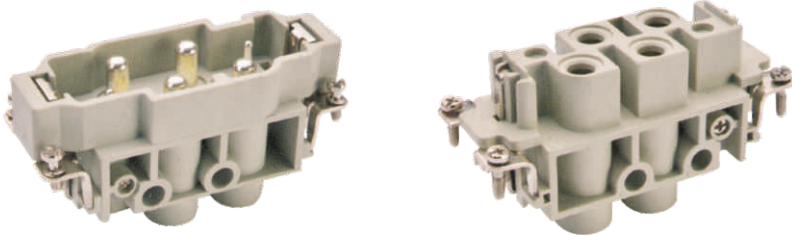

## Current carrying capacity

The current carrying is limited by maximum temperature of materials for inserts and contacts including terminals

DIN IEC 60512-5 Control and test procedures according to DIN IEC 60512-5

## Specifications

### Inserts

Number of contacts

Power area

Working current

Working voltage

Pollution degree

Rated impulse voltage

Signal area

Working current

Working voltage

Pollution degree

Rated impulse voltage

Pollution degree 2 also

Working voltage acc.to UL/CSA

Material

Insulation resistance

Flammability acc.to(UL94)

Limiting temperatures

Mechanical working life (mating cycles)

DIN EN 60 664

DIN EN 61 984

4/0+PE,4/2+PE

80A 830 V 3 8KV

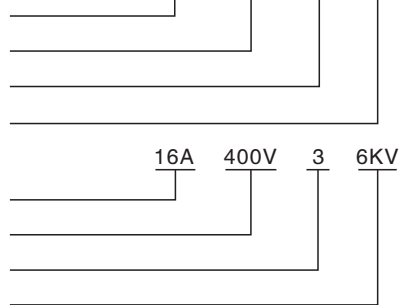

16A 400V 3 6KV

16A 400/690V 2 6KV

600V/300V

Polycarbonate

$\geq 10^{10} \Omega$

VO

-40°C ~ +125°C

$\geq 500$

### Contacts

Material

Surface

Contact resistance

Terminal

Wire gauge

Screw terminal tightening

Copper alloy

Silver plated

Power area  $\leq 3m \Omega$

Signal area  $\leq 1m \Omega$

Screw terminal

Power area 1.5-16mm (AWG#16-6)

Signal area 1.0-2.5mm (AWG#8-14)

Signal area 0.5Nm

Power area

mm <sup>2</sup>	1.5	2.5	4	6	10	16
N.m	1.2	2	3	3	3	3

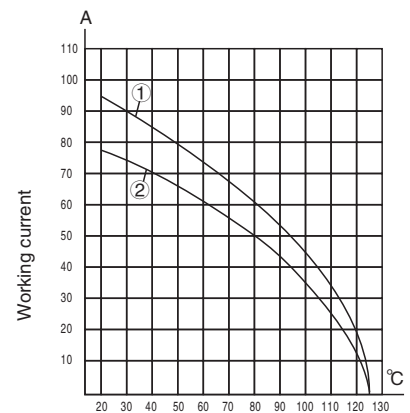

Ambient temperature

① wire gauge: 16mm<sup>2</sup>

② wire gauge: 10mm<sup>2</sup>

HK

# SO-HK

Number of contacts

Insert 830/400V 80/16A

## 4/0, 4/2+ ⊕

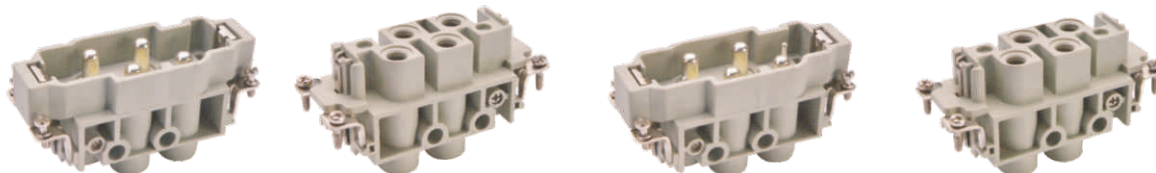

TYPE	SO-HK-4/0-M	SO-HK-4/0-F	SO-HK-4/2-M	SO-HK-4/2-F
------	-------------	-------------	-------------	-------------

Drawing (Dimensions in mm)

Male insert (M)

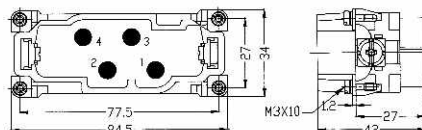
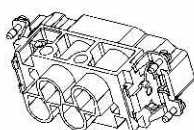

SO-HK-4/0-M

Female insert (F)

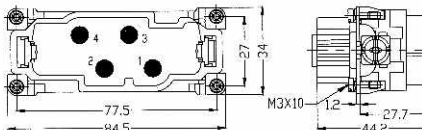
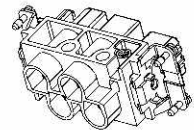

SO-HK-4/0-F

Male insert (M)

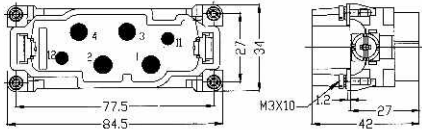
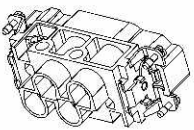

SO-HK-4/2-M

Female insert (F)

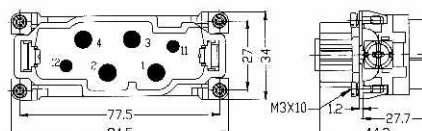
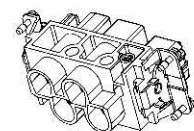

SO-HK-4/2-F

Panel cut out for inserts  
for use without hoods/housings

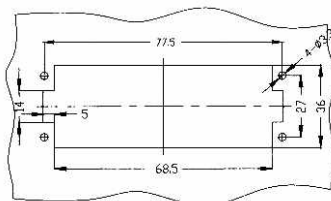

Note: Suit hood/housing: Size H24B

Hood/Housing detail on "Hood/Housing" section

# HK | Technical characteristics

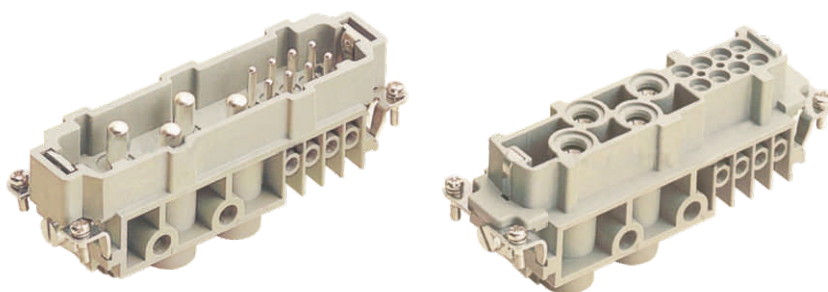

## Current carrying capacity

The current carrying is limited by maximum temperature of materials for inserts and contacts including terminals

DIN IEC 60512-5 Control and test procedures according to DIN IEC 60512-5

## Specifications

### Inserts

- Number of contacts
- Power area
- Working current
- Working voltage
- Pollution degree
- Rated impulse voltage
- Pollution degree 2 also
- Signal area
- Working current
- Working voltage
- Pollution degree
- Rated impulse voltage
- Working voltage acc.to UL/CSA
- Material
- Insulation resistance
- Flammability acc.to(UL94)
- Limiting temperatures
- Mechanical working life (mating cycles)

DIN EN 60 664

DIN EN 61 984

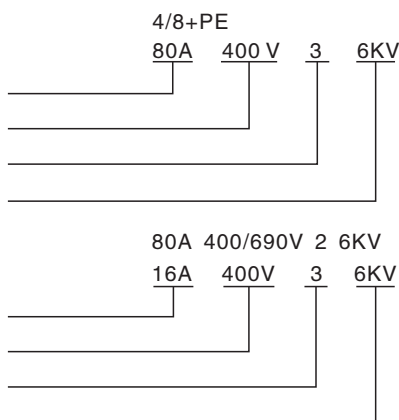

600V/600V

Polycarbonate

$\geq 10^{10} \Omega$

VO

$-40^{\circ}\text{C} \sim +125^{\circ}\text{C}$

$\geq 500$

### Contacts

- Material
- Surface
- Contact resistance
- Terminal
- Wire gauge
- Screw terminal tightening

Copper alloy

Silver plated

Power area  $\leq 3\text{m}\Omega$

Signal area  $\leq 1\text{m}\Omega$

Screw terminal

Power area 1.5-16mm (AWG16-6)

Signal area 0.5-2.5mm (AWG20-14)

Signal area 0.5Nm

Power area

mm <sup>2</sup>	1.5	2.5	4	6	10	16
N.m	1.2	2	3	3	3	3

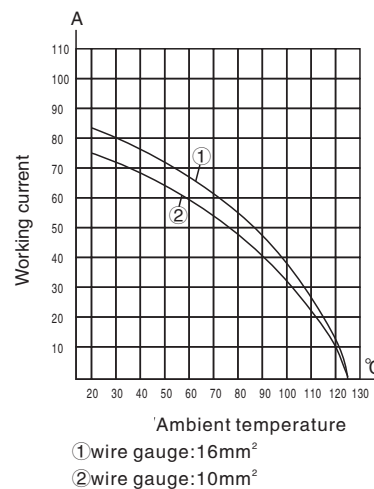

HK

# SO-HK

Number of contacts

4/8+ 

Insert 400/400V 80/16A

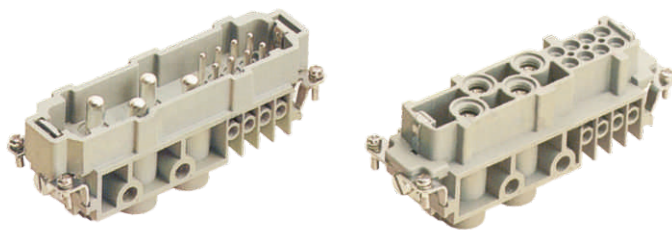

TYPE

SO-HK-4/8-M

SO-HK-4/8-F

Drawing (Dimensions in mm)

Male insert (M)

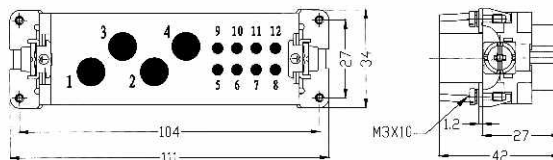
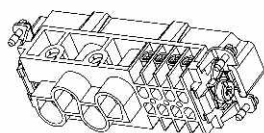

Female insert (F)

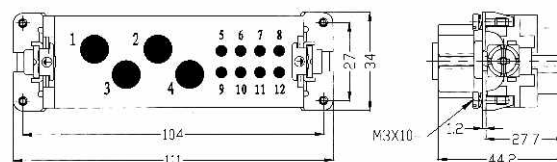
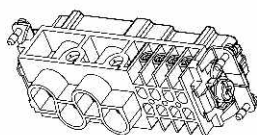

Panel cut out for inserts  
for use without hoods/housings

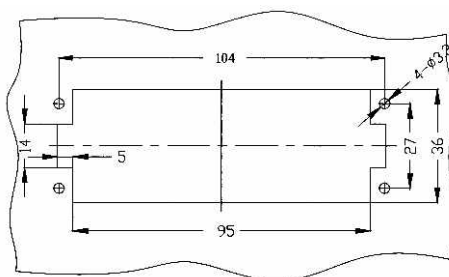

Note: Suit hood/housing: Size H24B

Hood/Housing detail on "Hood/Housing" section

# HK

Technical characteristics

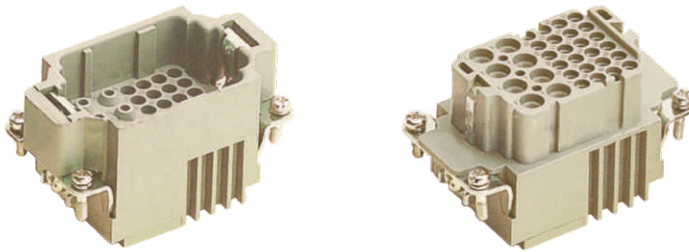

## Current carrying capacity

The current carrying is limited by maximum temperature of materials for inserts and contacts including terminals

DIN IEC 60512-5 Control and test procedures according to DIN IEC 60512-5

## Specifications

DIN EN 60 664

DIN EN 61 984

### Inserts

Number of contacts

Power area

Working current

Working voltage

Pollution degree

Rated impulse voltage

Pollution degree 2 also

Signal area

Working current

Working voltage

Pollution degree

Rated impulse voltage

Working voltage acc.to UL/CSA

Material

Insulation resistance

Flammability acc.to(UL94)

Limiting temperatures

Mechanical working life (mating cycles)

8/24+PE  
16A 230 V/400V 3 4KV

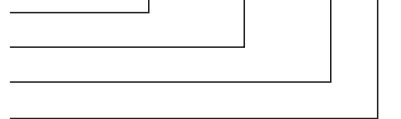

10A 250V 2 4KV  
10A 160V 3 2.5KV

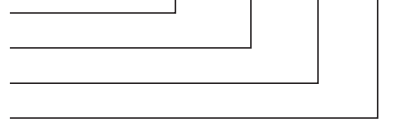

600V/300V

Polycarbonate

$\geq 10^{10} \Omega$

VO

$-40^{\circ}\text{C} \sim +125^{\circ}\text{C}$

$\geq 500$

### Contacts

Material

Copper alloy

Surface

Gold plated

Contact resistance

Silver plated

$\leq 1\text{m}\Omega/3\text{m}\Omega$

Terminal

Crimp terminal

Wire gauge

$0.5-4.0\text{mm}^2/0.14-2.5\text{mm}^2$

AWG20-12/26-14

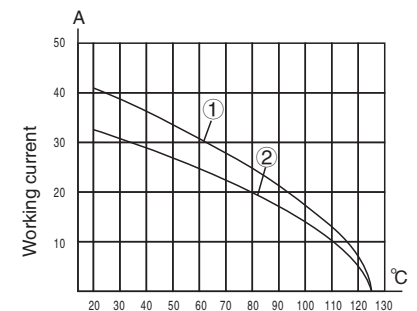

Ambient temperature

① wire gauge: 4.0mm<sup>2</sup>

② wire gauge: 2.5mm<sup>2</sup>

HK

# SO-HK

Number of contacts

Insert 400/100V 16/10A

## 8/24+ ⊕

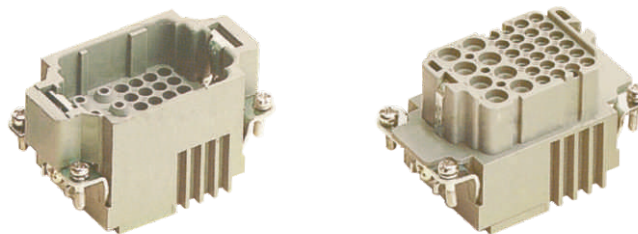

TYPE

SO-HK-8/24-MC

SO-HK-8/24-FC

Drawing (Dimensions in mm)

Male insert (MC)

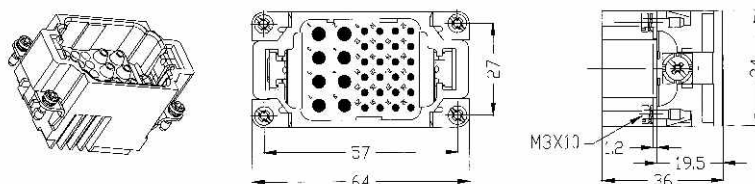

Female insert (FC)

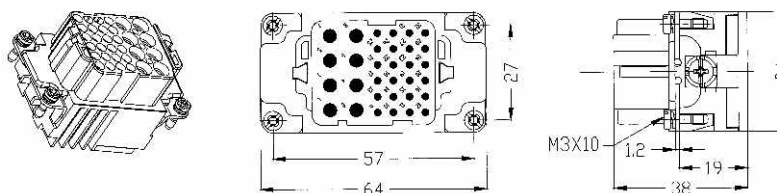

Panel cut out for inserts  
for use without hoods/housings

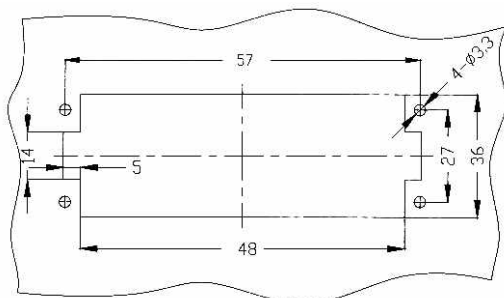

Note: Suit hood/housing: Size H10B

Hood/Housing detail on "Hood/Housing" section

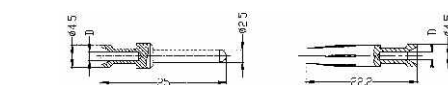

Crimp contacts	Wire gauge	D	Stripping length
Gold plated	0.14–0.37mm <sup>2</sup>	AWG 26–22	0.90mm
	0.5mm <sup>2</sup>	AWG 20	1.10mm
	0.75mm <sup>2</sup>	AWG 18	1.30mm
	1.0mm <sup>2</sup>	AWG 18	1.45mm
Silver plated	1.5mm <sup>2</sup>	AWG 16	1.75mm
	2.5mm <sup>2</sup>	AWG 14	2.25mm
	3.0mm <sup>2</sup>	AWG 12	2.55mm
	4.0mm <sup>2</sup>	AWG 12	2.85mm

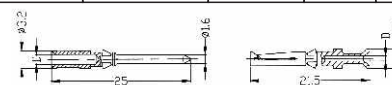

Crimp contacts	Wire gauge	D	Stripping length
Gold plated	0.14–0.37mm <sup>2</sup>	AWG 26–22	0.90mm
	0.5mm <sup>2</sup>	AWG 20	1.10mm
	0.75mm <sup>2</sup>	AWG 18	1.30mm
Silver plated	1.0mm <sup>2</sup>	AWG 18	1.45mm
	1.5mm <sup>2</sup>	AWG 16	1.75mm
	2.5mm <sup>2</sup>	AWG 14	2.25mm

Note: Crimp termina of 10/16A should order contacts pins separately, detail please refer to page 74